



Equipped with AEM® Dryflow™ Filter
No Oil Required!

INSTALLATION INSTRUCTIONS PART NUMBER:

21-729C (Gun Metal Grey Finish)

21-729P (Vacuum Metalized Chrome - VMC)

2010	MAZDA	MX-5 MIATA	2.0L L-4	C.A.R.B. E.O.# D-670-22
2011	MAZDA	MX-5 MIATA	2.0L L-4	C.A.R.B. E.O.# D-670-22
2012	MAZDA	MX-5 MIATA	2.0L L-4	C.A.R.B. E.O.# D-670-22
2013	MAZDA	MX-5 MIATA	2.0L L-4	C.A.R.B. E.O.# D-670-22
2014	MAZDA	MX-5 MIATA	2.0L L-4	C.A.R.B. E.O.# D-670-22

**Intake systems for vehicles listed are 50
state legal. See AEMIntakes.com for CARB
status on each part for a specific vehicle.**

PARTS LIST

Description	Qty.	Part Number
A	1	2-705C/P
B	1	21-203DK
C	1	5-273
D	1	2-1505C/P
E	2	1-2023
F	2	1228598
G	4	08160
H	4	444.460.04
I	1	9444
J	1	9448
K	1	9452
L	1	1-4000

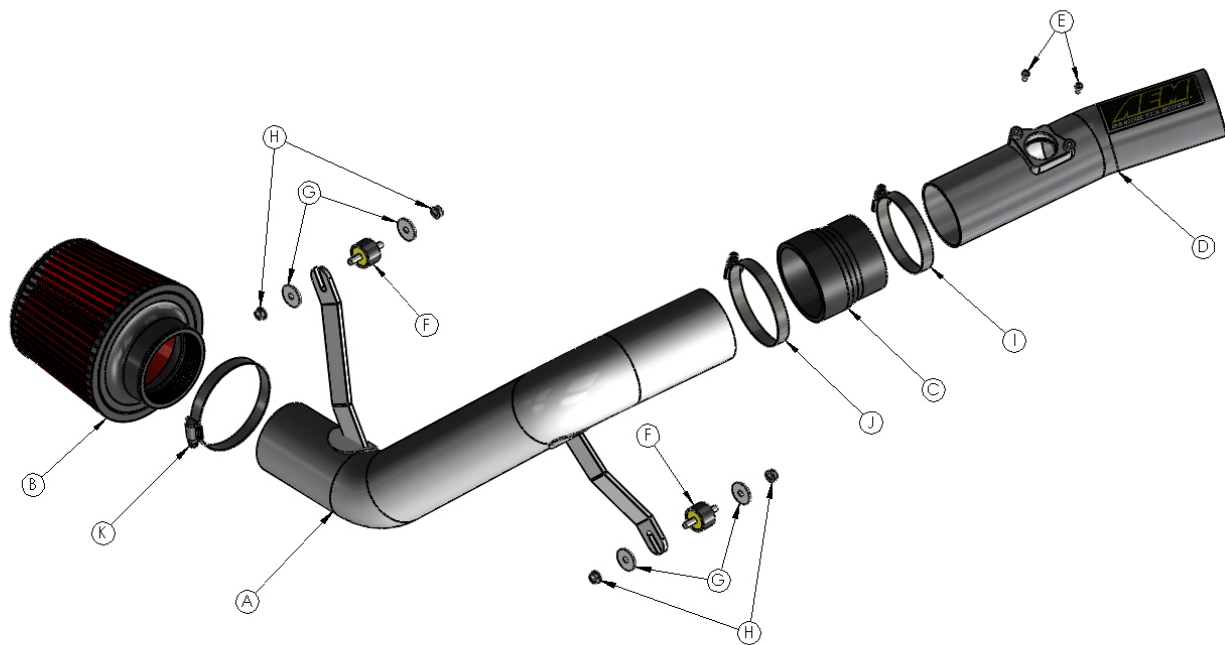

Read and understand these instructions **BEFORE** attempting to install this product. Failure to follow installation instructions and not using the provided hardware may damage the intake tube, throttle body and engine.

1. Preparing Vehicle

- a. Make sure vehicle is parked on level surface.
- b. Set parking brake.
- c. If engine has run in the past two hours, let it cool down.
- d. Disconnect negative battery terminal.
- e. Raise the front of the vehicle with a jack. Refer to your owner's manual for proper jack and jack stand placement to properly support vehicle. Support your vehicle using properly rated jack stands before wheel removal or while working under the vehicle.

NEVER WORK UNDER A VEHICLE WITHOUT USING JACK STANDS.

- f. Do not discard stock components after removal of the factory system.

2. Removal of stock system

WARNING: Please follow these installation instructions carefully. The AEM® prefilter included with this kit must be installed on the AEM® air filter when used with a AEM® intake system. The AEM® intake system is a performance product that can be used safely during mild weather conditions. During harsh and inclement weather conditions, you must return your vehicle to stock OEM air box and intake tract configuration. Failure to follow these instructions will void your warranty.

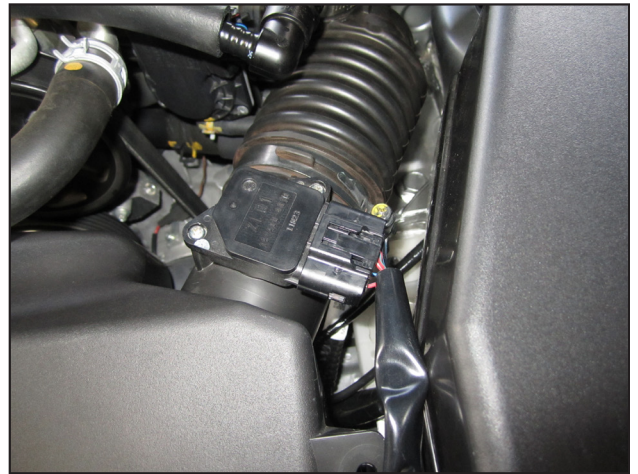

a. Loosen the hose clamp securing the air box outlet tube to the flexible elbow coupler at the throttle body. Disconnect the coupler.



b. Unplug the MAF sensor from the wiring harness.

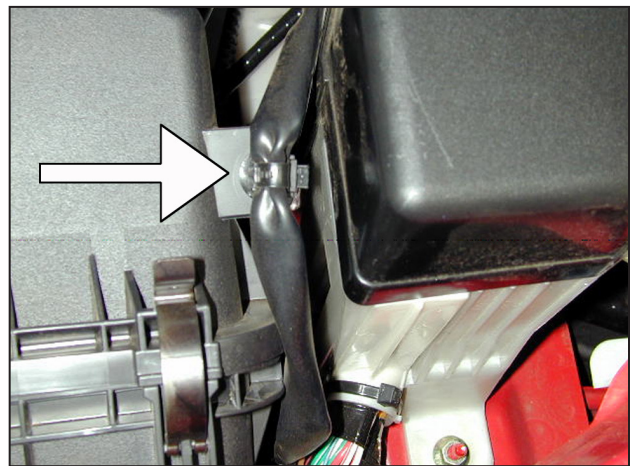

c. Unclip the MAF sensor wiring harness from the side of the air filter housing.

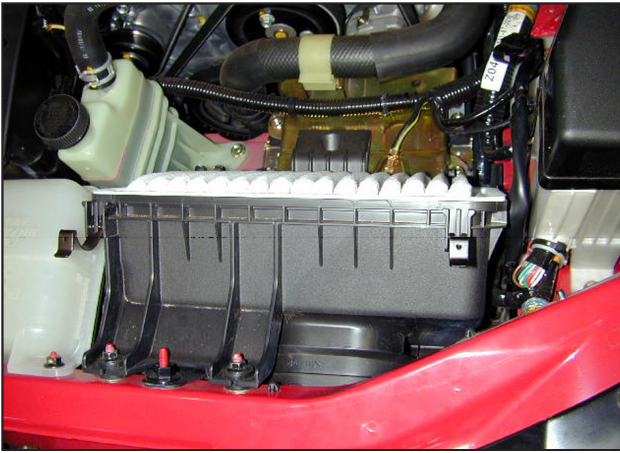

d. Remove the upper air filter housing by unhooking the metal retaining clips and sliding it out.

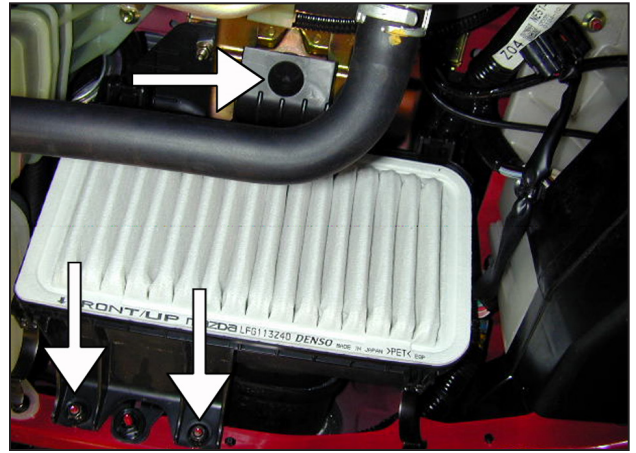

e. Remove the lower air filter housing and filter by removing the two nuts securing the housing to the chassis. Next, lift up on the back side of the housing and remove it from the vehicle.



f. Remove the retaining clips and bolts securing the driver side splash shield to the vehicle. Remove the splash shield.

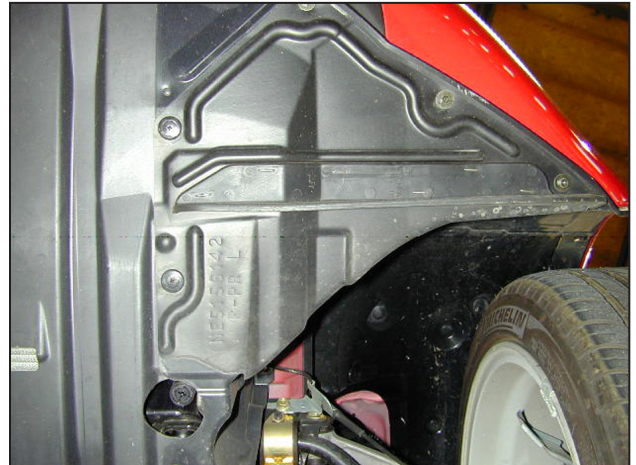

g. Remove the retaining clips and bolts securing the passenger side splash shield to the vehicle. Remove the splash shield.



h. Remove the clips and bolts securing the center splash shield to the vehicle. Remove the splash shield.



i. Remove the clips and bolts securing the driver side front fender liner and remove the liner. Disconnect the fog light and side marker light from the wiring harness.



j. Remove the clips and bolts securing the passenger side front fender liner and remove the liner. Disconnect the fog light and side marker light from the wiring harness.



k. Remove the 2 small plastic covers in the grille fascia to reveal 2 bolts securing the bumper cover to the bumper support. Remove the 2 bolts.



l. Remove the 1 bolt and 2 nuts securing the bumper cover to the driver side fender where the fender liner was removed.



m. Remove the 1 bolt and 2 nuts securing the bumper cover to the passenger side fender where the fender liner was removed.



n. Remove the 8 bolts securing the bumper cover to the top of the radiator support.



o. Carefully remove the front bumper cover to reveal the stock inlet air tube and the bumper assembly.

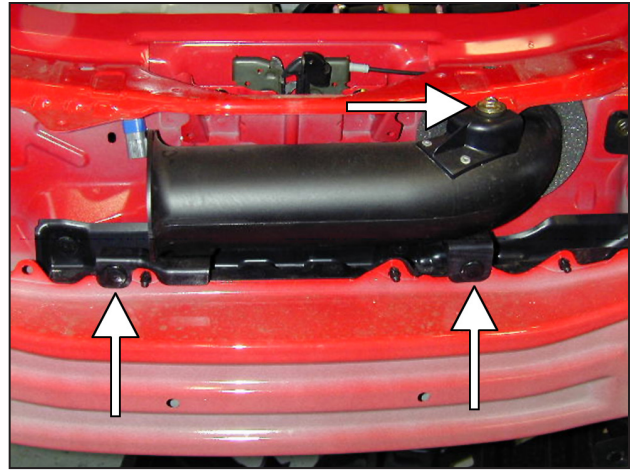

p. Remove the inlet air tube by removing the two retaining clips and the bolt securing it to the chassis.

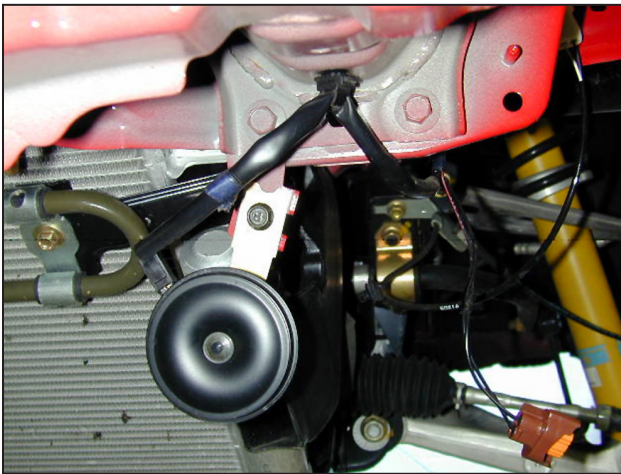

r. Disconnect and unhook the wiring harness from the horn attached to the front bumper support. Unhook the clips attaching the IAT sensor to the bumper beam. Remove the plastic clips securing the plastic splash shield to the bumper support and the chassis.



s. Remove the 8 large bolts securing the bumper supports to the chassis. Remove the bumper beam assembly.

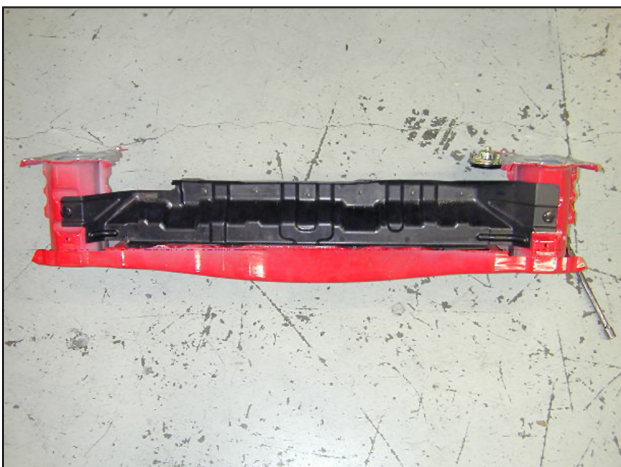

t. Remove the splash shield by removing the plastic clips securing it to the bumper assembly.

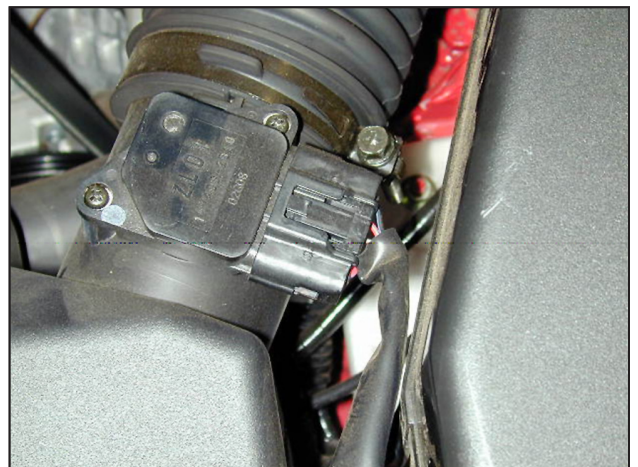

u. Remove the MAF sensor from the stock housing using a screwdriver.

3. Installation of AEM® Cold Air Intake system.

a. When installing the intake system, do not completely tighten the hose clamps or mounting hardware until instructed to do so.



a. Install the MAF sensor into the upper intake tube (D) and secure using the two supplied 8-32 Allen bolts (E). Install the reducing coupler onto the end of the intake pipe and secure with the #44 hose clamp (I). Loosely install the larger #48 hose clamp (J) onto the end of the coupler.



b. Install the AEM® upper intake tube (D) into the stock elbow coupler at the throttle body as shown. Secure using the stock hose clamp. Connect the MAF sensor wiring harness to the MAF sensor.

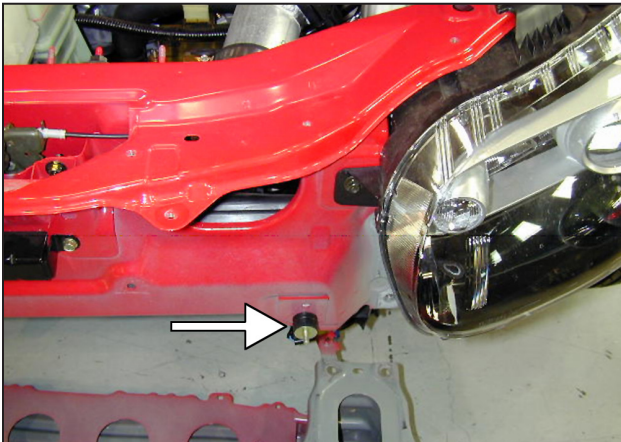

c. Install the supplied M6 isolator mount (F) in the location shown. Secure using the supplied M6 flat washer (G) and M6 nut (H).

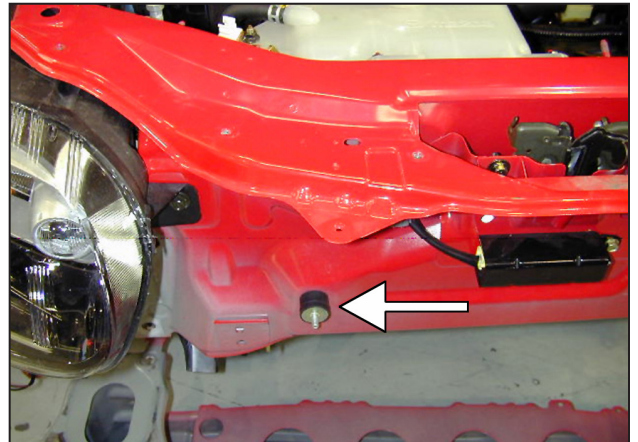

d. Install the other M6 isolator mount (F) in the location shown. Secure using the supplied M6 flat washer (G) and M6 nut (H).

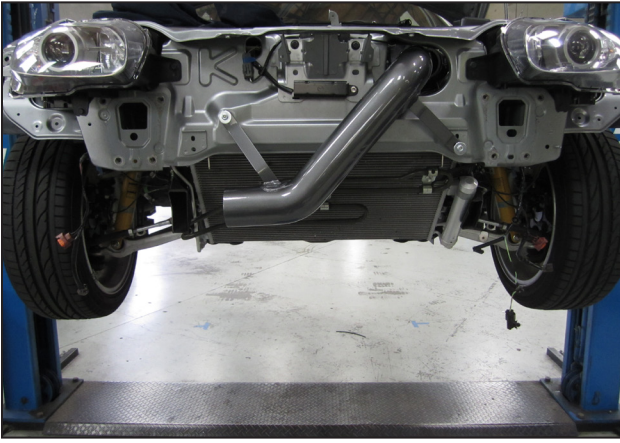

e. Loosely mount the lower intake tube (A) brackets to the isolator mounts as shown using 2 flat washers (G) and 2 M6 nuts (H) turned finger tight.



g. Install the AEM® prefilter (L) over your new AEM® Dryflow air filter (B), then mount the filter onto the end of the lower intake pipe using the #52 hose clamp (K) and fully tighten.

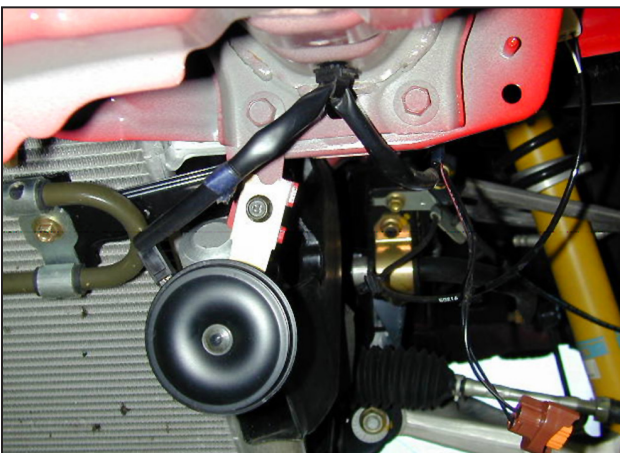

i. Re-install the clip for the horn wiring harness from the horn to the front bumper support. Re-install the clips attaching the IAT sensor and wiring harness to the bumper beam.



f. Install the lower tube into the reducing coupler on the upper intake pipe and align the tube brackets with the rubber mounts. Once aligned, secure the pipe with the #48 hose clamp (J) and then fully tighten the 2 M6 nuts from Step e. with a wrench.



h. Re-install the front bumper assembly using the 8 factory bolts. Ensure the air filter or intake tube does not contact any part of the vehicle.



j. Position the AEM® intake for best fitment. Tighten the nuts on the mounting brackets. Re-adjust the pipe if necessary.

4. Reassemble Vehicle

- a. Reinstall the bumper cover and reconnect the fog light and the side marker wiring harness connectors. Reinstall the wheel well liners and splash shields under the vehicle.
- b. Position the inlet pipes for the best fitment. Be sure that the pipes or any other components do not contact any part of the vehicle. Tighten the rubber mount, all bolts, and hose clamps.
- c. Check for proper hood clearance. Re-adjust pipes if necessary and re-tighten them.
- d. Inspect the engine bay for any loose tools and check that all fasteners that were moved or removed are properly tightened.
- e. Reconnect the negative battery terminal and start the engine. Let the vehicle idle for 3 minutes. Perform a final inspection before driving the vehicle.

5. CARB Sticker Placement

- a. The C.A.R.B. exemption sticker, (attached), must be visible under the hood so that an emissions inspector can see it when the vehicle is required to be tested for emissions. California requires testing every two years, other state may vary..

6. Service and Maintenance

- a. AEM Induction Systems requires cleaning the intake system's air filter element every 100,000 miles. When used in dusty or off-road environments, our filters will require cleaning more often. We recommend that you visually inspect your filter once every 25,000 miles to determine if the screen is still visible. When the screen is no longer visible some place on the filter element, it is time to clean it. To clean, purchase our AEM Synthetic air filter cleaner, part number 1-1000 and follow the easy instructions.
- b. Use a damp cloth or glass cleaner to clean your powder coated AEM® intake tube.
NOTE: DO NOT USE aluminum polish on powder coated AEM® intake tubes.
- c. Please be aware that the prefilter is water repellent, not water proof. Depending on conditions and usage the water repellent treatment is good for 1 to 2 years. Inspect after inclement weather and replace if necessary.

For technical inquiries
e-mail us at
sales@aemintakes.com
or
call us at
800.992.3000

AEM Air Intake System Warranty Policy

AEM® warrants that its intake systems will last for the life of your vehicle. AEM will not honor this warranty due to mechanical damage (i.e. improper installation or fitment), damage from misuse, accidents or flying debris. AEM will not warrant its powder coating if the finish has been cleaned with a hydrocarbon-based solvent. The powder coating should only be cleaned with a mild soap and water solution. Proof of purchase of both the vehicle and AEM intake system is required for redemption of a warranty claim.

This warranty is limited to the repair or replacement of the AEM part. In no event shall this warranty exceed the original purchase price of the AEM part nor shall AEM be responsible for special, incidental or consequential damages or cost incurred due to the failure of this product. Warranty claims to AEM must be transportation prepaid and accompanied with dated proof of purchase. This warranty applies only to the original purchaser of product and is nontransferable. Improper use or installation, use for racing, accident, abuse, unauthorized repairs or alterations voids this warranty. AEM disclaims any liability for consequential damages due to breach of any written or implied warranty on all products manufactured by AEM. Warranty returns will only be accepted by AEM when accompanied by a valid Return Merchandise Authorization (RMA) number. Credit for defective products will be issued pending inspection. Product must be received by AEM within 30 days of the date RMA is issued.

If you have a warranty issue, please call (800) 992-3000 and our customer service department will assist you. A proof of purchase is required for all AEM warranty claims.

**Intake systems for vehicles listed are 50
state legal. See AEMIntakes.com for CARB
status on each part for a specific vehicle.**