

Air Lift[™]
PERFORMANCE

Kit 75521

Nissan Z34 370z
Infiniti G37
(except AWD)

Front Application



CAUTION

READ PAGE 6 BEFORE
INSTALLATION

AIR LIFT
PERFORMANCE[™]

INSTALLATION GUIDE

For maximum effectiveness and safety,
please read these instructions completely
before proceeding with installation.

*Failure to read these instructions can result in an
incorrect installation.*

TABLE OF CONTENTS

Introduction	2
Notation Explanation	2
Important Safety Notices	2
Installation Diagram	3
Hardware List	3
Installing the Air Suspension	4
Preparing the Vehicle	4
Stock Shock Removal	4
Air Suspension Installation	5
Damping Adjustment	7
Aligning the Vehicle	7
Adjusting Extended or Drop Height Using Lower Mount	8
Before Operating	9
Installation Checklist	9
Post-installation checklist	9
Product Use, Maintenance and Servicing	10
Suggested Driving Air Pressure and Maximum Air Pressure	10
Maintenance Guidelines	10
Troubleshooting Guide	10
Frequently Asked Questions	10
Tuning the Air Pressure	11
Checking for Leaks	11
Fixing Leaks	11
Warranty and Returns Policy	12
Replacement Information	12
Contact Information	12

Introduction

The purpose of this publication is to assist with the installation, maintenance and troubleshooting of this Nissan/Infiniti Performance suspension kit.

It is important to read and understand the entire installation guide before beginning installation or performing any maintenance, service or repair. The information includes a hardware list, step-by-step installation information, maintenance tips, safety information and a troubleshooting guide.

Air Lift Company reserves the right to make changes and improvements to its products and publications at any time. For the latest version of this manual, contact Air Lift Company at (800) 248-0892 or visit our website at www.airliftperformance.com.

NOTATION EXPLANATION

Hazard notations appear in various locations in this publication. Information which is highlighted by one of these notations must be observed to help minimize risk of personal injury or possible improper installation which may render the vehicle unsafe. Notes are used to help emphasize areas of procedural importance and provide helpful suggestions. The following definitions explain the use of these notations as they appear throughout this guide.

 DANGER

INDICATES IMMEDIATE HAZARDS WHICH WILL RESULT IN SEVERE PERSONAL INJURY OR DEATH.

 WARNING

INDICATES HAZARDS OR UNSAFE PRACTICES WHICH COULD RESULT IN SEVERE PERSONAL INJURY OR DEATH.

 CAUTION

INDICATES HAZARDS OR UNSAFE PRACTICES WHICH COULD RESULT IN DAMAGE TO THE MACHINE OR MINOR PERSONAL INJURY.

NOTE

Indicates a procedure, practice or hint which is important to highlight.

IMPORTANT SAFETY NOTICES

The installation of this kit does not alter the Gross Vehicle Weight Rating (GVWR) or payload of the vehicle. Check your vehicle's owner's manual and do not exceed the maximum load listed for your vehicle.

Gross Vehicle Weight Rating: The maximum allowable weight of the fully loaded vehicle (including passengers and cargo). This number — along with other weight limits, as well as tire, rim size and inflation pressure data — is shown on the vehicle's Safety Compliance Certification Label.

Payload: The combined, maximum allowable weight of cargo and passengers that the vehicle is designed to carry. Payload is GVWR minus the Base Curb Weight.

 WARNING

DO NOT INFLATE AIR SPRINGS WHILE OFF OF THE VEHICLE. DAMAGE TO ASSEMBLY MAY RESULT AND VOID WARRANTY.

 CAUTION

DO NOT WELD TO, OR MODIFY PERFORMANCE STRUTS/SHOCKS IN ANY WAY. DAMAGE TO UNIT MAY OCCUR AND WILL VOID WARRANTY.

Installation Diagram

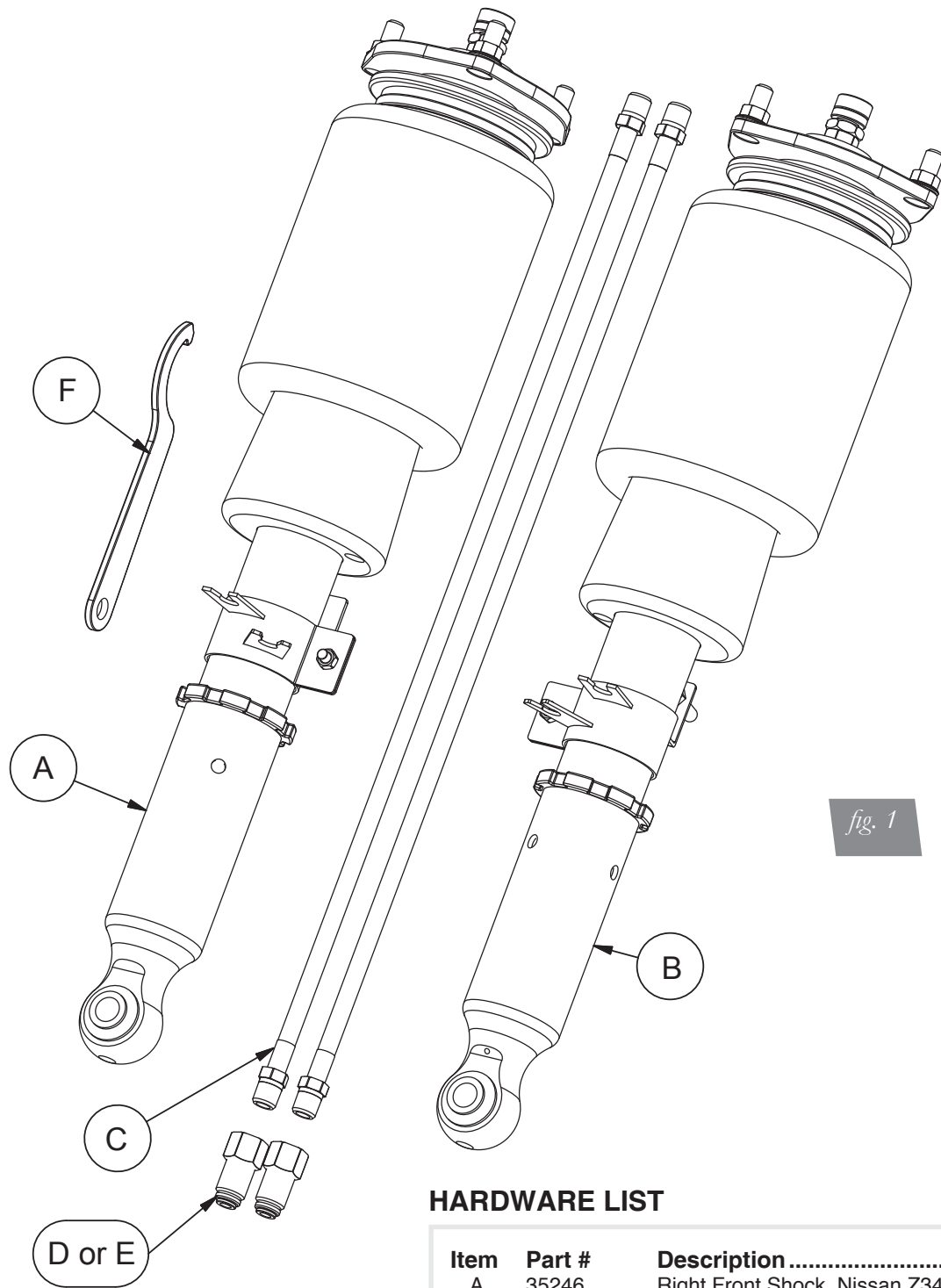

HARDWARE LIST

Item	Part #	Description	Qty
A	35246	Right Front Shock, Nissan Z34	1
B	35247	Left Front Shock, Nissan Z34.....	1
C	20997	Leader Hose, 1/4" NPT	2
D	21810	1/4"FNPT-1/4"PTC Fitting "DOT"	2
E	21987	1/4"FNPT X 3/8"PTC Fitting "DOT"	2
F		Spanner Wrench	1



Missing or damaged parts? Call Air Lift customer service at (800) 248-0892 for a replacement part.

Installing the Air Suspension

PREPARING THE VEHICLE

1. Elevate and support the vehicle with jack stands or a hoist at approved lifting points.
2. Remove the front wheels.

STOCK SHOCK REMOVAL

1. Support the hub assembly to prevent over-extension of suspension components.
2. Disconnect the stabilizer bar end link from the stabilizer bar. Unthread the lower shock mount nut from the stabilizer bar end link and remove end link from the vehicle (figs. 2-4).



3. Disconnect the wheel speed sensor wire and brake line from the shock (figs. 5 & 6).

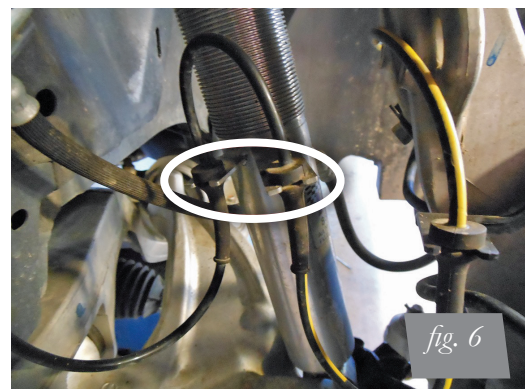

4. Within the engine compartment, unbolt and remove the three shock upper mount bolts. 370z models will need to have the shock tower brace removed to access the upper shock mounts (fig. 7).

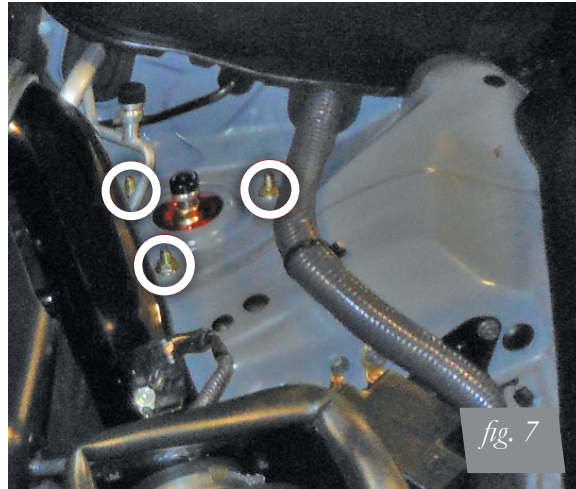

5. Remove shock from the vehicle and remove the thin gasket material from the shock upper bracket and place on the new assembly (fig. 8).



AIR SUSPENSION INSTALLATION

1. Install the leader line into the air spring (fig. 9). Seal the threads of the leader hose with Teflon tape or thread sealant. Tighten the appropriate fitting to the airline 1 3/4 turns beyond hand tight. Tighten the leader line into the air spring 1 3/4 turns beyond hand tight.

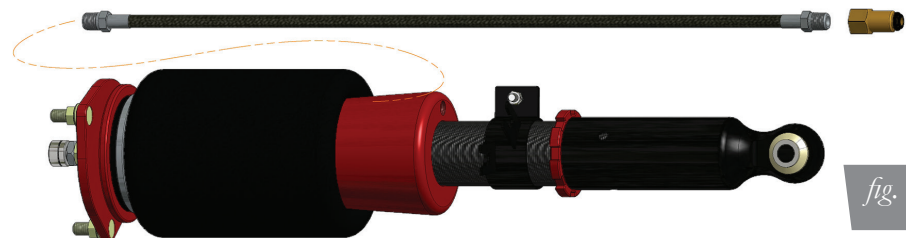

2. Insert the shock assembly into the shock tower and attach the upper bracket to the chassis. The shock should be installed so that the air spring air port is directed towards the engine compartment. Torque the upper bracket nuts to 38.5Nm (28 lb-ft).

3. Attach the shock eye mount to the lower transverse link. Do not torque the attaching bolt at this time.
4. Clip the wheel speed sensor wire onto the bracket on the shock body. Fasten the brake line to this bracket and torque to 22Nm (16 lb-ft).
5. 370z models: Reattach the tower brace. Torque to 45Nm (33 lb-ft).
6. Fully compress the suspension using a jack. With the suspension compressed, review the best routing for the leader hose that is clear of all suspension components and axle. Routing should also allow for the suspension to extend without kinking or pulling the line tight or rubbing on other components. Following the brake line routing is often a good place to start. Check clearances to all other components.

CAUTION

AFTER INITIAL INSTALLATION OF YOUR STRUTS/SHOCKS:

- DO NOT CYCLE THE SUSPENSION WITH THE AIR-LINE CONNECTED TO THE LEADER HOSE WITHOUT FIRST ADDING AIR SPRING PRESSURE. DOING SO MAY CAUSE THE AIR SPRING TO IMPROPERLY INFLATE (FIG.10). IT IS SAFE TO CYCLE THE SUSPENSION TO CHECK FOR CLEARANCES ETC. WITH THE LEADER HOSE OPEN TO ATMOSPHERE (DISCONNECTED FROM AIR-LINE).
- BEFORE SETTING VEHICLE ON THE GROUND FOR THE FIRST TIME, IT IS VERY IMPORTANT TO INFLATE THE AIR SPRINGS TO AT LEAST 50PSI. THIS WILL PREVENT ANY POSSIBILITY OF THE AIR SPRING KICKING OUT AND CAUSING A LEAK (FIG.11).



fig. 10

Caused by cycling with air-line attached without pressure. Remove air-line from spring to release vacuum and re-attach. Inflate to 50+psi before lowering car to ground.



fig. 11

Shows what spring looks like after lowering car to ground with <50psi and raising it with air pressure. Do NOT drive!



fig. 12

Shows what spring looks like when installed correctly.

7. With the suspension fully compressed, take a measurement from the fender to some reference point – typically the center of the axle. Record this measurement as Max Compression.
8. Cycle the suspension to Max Extension and record the measurement from the same reference points.

- Add ME and MC then divide by 2. Set the suspension to this point. This position will give 50% stroke in either direction and is a starting point for ride height (fig. 13).

Formula for Calculating Ride Height

$(ME+MC) \div 2 = \text{MID STROKE}$

fig. 13

- With the suspension at this position, loosen, then re-torque the lower control arm bolts to manufacturer’s specifications (Table 1).

Torque Specifications		
Location	Nm	lb-ft
Upper bracket to chassis	38.5	28
Upper control arms to bracket	70	52
Transverse link to shock clevis	107	79
Transverse link to subframe	130	96
Stabilizer link to transverse link	87.5	65
Wheels	99-126	73-93
Tower brace	45	33
Brake line bracket nut	22	16

Table 1

DAMPING ADJUSTMENT

The shocks in this kit have 30 settings, or “clicks”, of adjustable compression and rebound damping characteristics. Damping is changed through the shock rod using the supplied adjuster (figs. 14 and 15) or a 3mm allen wrench.

Turn the adjuster clockwise and the damping settings are hardened. Turn the adjuster counterclockwise and the damping is softened.

Each shock is preset to “-18 clicks”. This means that the shock is adjusted 18 clicks away from full stiff. Counting down from full stiff is the preferred method of keeping track of, or setting, damping. This setting was developed on a 2012 Infiniti G37 sedan and may need to be adjusted to different vehicles and driving characteristics.



fig. 14

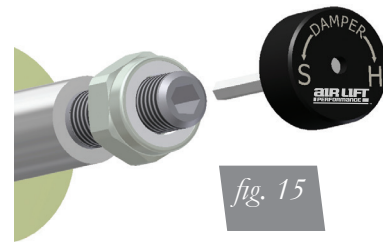

fig. 15

ALIGNING THE VEHICLE

- Using the control system, set the vehicle height to the new custom ride height.
- If the custom ride height is lower than stock, we recommend loosening all pivot points (bolts, nuts) on any control arm, strut arm or radius rod that contains bushings. Once they have been loosened, re-torque to stock specifications.

NOTE

It may be necessary to cycle the suspension to loosen the bushing up from its mount. This will help re-orient the bushing at its new position and increase life of the bushings based on the custom ride height.

ADJUSTING EXTENDED OR DROP HEIGHT USING LOWER MOUNT

Your struts have been pre-set at the factory to provide maximum drop height while maintaining adequate tire clearance to the air spring. If you wish to gain more extended height (lift), which is the same as reducing drop height, or want to lower the chassis further and there is still adjustment available at the lower mount, please use the following procedure:

1. Support the vehicle with jack stands or a hoist at approved lifting points.
2. Remove the wheel.
3. Using the supplied spanner wrench, loosen the lower locking collar (fig. 16).
4. Deflate the air spring to 0 PSI on the corner you are adjusting.
5. Disconnect lower mount from suspension.
6. Spin the lower mount to the desired location.

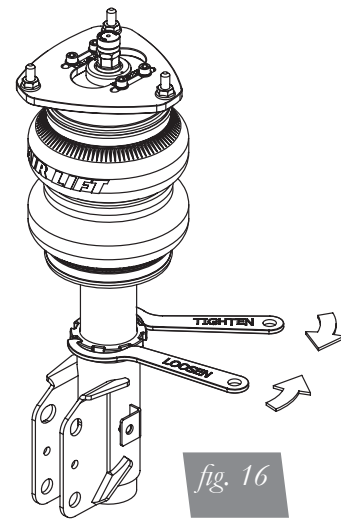

NOTE

Not all models will have further drop height available.

7. Re-install lower mount to suspension and torque fasteners.
8. Tighten the lower locking collar to the lower mount using significant force.

CAUTION

WHEN ADJUSTING HEIGHT UPWARDS, MAKE SURE THAT THE STRUT BODY ENGAGES ALL THE THREADS OF THE LOWER MOUNT (FIG. 17). WHEN ADJUSTING DOWNWARDS, MAKE SURE THERE IS ADEQUATE AIR SPRING CLEARANCE TO THE TIRE/WHEEL ASSEMBLY. CLEARANCE MUST BE CHECKED WITH SYSTEM FULLY DEFLATED AS WELL AS FULLY INFLATED TO ENSURE THAT NO RUBBING OCCURS. FAILURE TO MAINTAIN ADEQUATE CLEARANCE CAN RESULT IN AIR SPRING FAILURE AND WILL NOT BE COVERED UNDER WARRANTY.

CAUTION

DO NOT ADJUST HEIGHT BY SPINNING AIR SPRING ON STRUT! DOING SO MAY CAUSE AN AIR LEAK AND COMPROMISE THE ASSEMBLY.

FOR STRUTS:

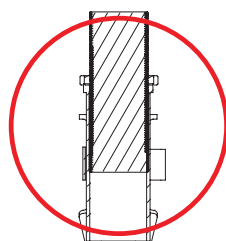
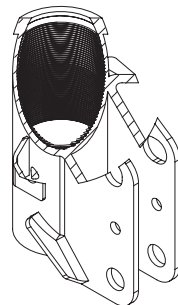

OK, no threads showing.



Not OK, threads are showing.

FOR SHOCKS:

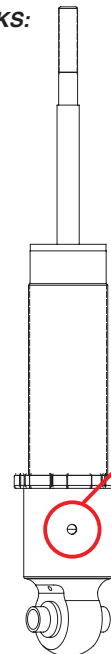

Thread
MUST be
showing in
window.

fig. 17

Before Operating

CAUTION

MAKE SURE THE FRONT WHEELS ARE STRAIGHT WHEN DEFLATING AND REINFLATING AIR BAGS.

1. Inflate and deflate the system (do not exceed 125 PSI) to check for clearance or binding issues. With the air springs deflated, check clearances on everything so as not to pinch brake lines, vent tubes, etc. Clear lines if necessary.
2. Inflate the air springs to 75-90 PSI and check all connections for leaks.
3. Air Lift part #27669 AutoPilot V2 Air Management System, is highly recommended for this product.
4. Please continue by reading the Product Use, Maintenance and Servicing section.

INSTALLATION CHECKLIST

- Clearance test — Inflate the air springs to 75-90 PSI and make sure there is at least ½” clearance from anything that might rub against each sleeve. Be sure to check the tire, brake drum, frame, shock absorbers and brake cables.
- Leak test before road test — Inflate the air springs to 75-90 PSI and check all connections for leaks. All leaks must be eliminated before the vehicle is road tested.
- Heat test — Be sure there is sufficient clearance from heat sources, at least 6” for air springs and air lines. If a heat shield was included in the kit, install it. If there is no heat shield, but one is required, call Air Lift customer service at (800) 248-0892.
- Fastener test — Recheck all bolts for proper torque.
- Road test — The vehicle should be road tested after the preceding tests. Inflate the springs to recommended driving pressures. Drive the vehicle 10 miles and recheck for clearance, loose fasteners and air leaks.
- Operating instructions — If professionally installed, the installer should review the operating instructions with the owner. Be sure to provide the owner with all of the paperwork that came with the kit.

Technician's Signature _____

Date _____

POST-INSTALLATION CHECKLIST

- Overnight leak down test — Recheck air pressure after the vehicle has been used for 24 hours. If the pressure has dropped more than 5 PSI, then there is a leak that must be fixed. Either fix the leak yourself or return to the installer for service.
- Air pressure requirements — Regardless of load, the air pressure should always be adjusted to maintain adequate ride height at all times while driving.
- Thirty day or 500 mile test — Recheck the air spring system after 30 days or 500 miles, whichever comes first. If any part shows signs of rubbing or abrasion, the source should be identified and moved, if possible. If it is not possible to relocate the cause of the abrasion, the air spring may need to be remounted. If professionally installed, the installer should be consulted. Check all fasteners for tightness.

Product Use, Maintenance and Servicing

Suggested Driving Air Pressure	Maximum Air Pressure
100 PSI	150 PSI
FAILURE TO MAINTAIN ADEQUATE MINIMUM PRESSURE (OR PRESSURE PROPORTIONAL TO LOAD) WILL RESULT IN BOTTOMING OUT, OVER-EXTENSION OR RUBBING AGAINST ANOTHER COMPONENT AND WILL VOID THE WARRANTY.	

MAINTENANCE GUIDELINES

NOTE

By following these steps, vehicle owners will obtain the longest life and best results from their air spring.

1. Check the air pressure before driving.
2. Never inflate beyond 150 PSI.
3. If you develop an air leak in the system, use a soapy water solution to check all air line connections, before deflating and removing the spring.
4. When increasing load, always adjust the air pressure to maintain normal ride height. Increase or decrease pressure from the system as necessary to attain normal ride height for optimal ride and handling. Remember that loads carried behind the axle (including tongue loads) require more leveling force (pressure) than those carried directly over the axle.

CAUTION

FOR YOUR SAFETY AND TO PREVENT DAMAGE TO YOUR VEHICLE, DO NOT EXCEED MAXIMUM GROSS VEHICLE WEIGHT RATING (GVWR), AS INDICATED BY THE VEHICLE MANUFACTURER. ALTHOUGH YOUR AIR SPRINGS ARE RATED AT A MAXIMUM INFLATION PRESSURE OF 150 PSI, THE AIR PRESSURE ACTUALLY NEEDED IS DEPENDENT ON YOUR LOAD.

5. Always add air to the springs in small quantities, checking the pressure frequently. Sleeves require less air volume than a tire and inflate quickly.
6. Should it become necessary to raise the vehicle by the frame, make sure the control system is turned off before lifting.

TROUBLESHOOTING GUIDE

1. Leak test the air line connections, the threaded connection into the air spring, and all fittings in the control system.
2. Inspect the air lines to be sure none are pinched. Tie straps may be too tight. Loosen or replace the strap and replace leaking components.
3. Inspect the air line for holes and cracks. Replace as needed.
4. Look for a kink or fold in the air line. Reroute as needed.

If the preceding steps do not solve the problem, it is possibly caused by a failed air spring — either a factory defect or an operating problem. Please call Air Lift at (800) 248-0892 for assistance.

FREQUENTLY ASKED QUESTIONS

Q. Will installing air springs increase the weight ratings of a vehicle?

No. Adding air springs will not change the weight ratings (GAWR, GCWR and/or GVWR) of a vehicle. Exceeding the GVWR is dangerous and voids the Air Lift warranty.

Q. How long should air springs last?

If the air springs are properly installed and maintained they can last indefinitely.

Q. Will raising the vehicle on a hoist for service work damage the air springs?

No. The vehicle can be lifted on a hoist for short-term service work such as tire rotation or oil changes. However, if the vehicle will be on the hoist for a prolonged period of time, support the axle with jack stands in order to take the tension off of the air springs.

TUNING THE AIR PRESSURE

Pressure determination comes down to three things — level vehicle, ride comfort, and stability.

1. Level vehicle

If the vehicle's headlights are shining into the trees or the vehicle is leaning to one side, then it is not level. Raise the air pressure to correct either of these problems and level the vehicle.

2. Ride comfort

If the vehicle has a rough or harsh ride it may be due to either too much pressure or not enough. Try different pressures to determine the best ride comfort. See Air Lift suggested driving air pressure.

3. Stability

Stability translates into safety and should be the priority, meaning the driver may need to sacrifice a perfectly level and comfortable ride. Stability issues include roll control, bounce, dive during braking and sponginess. Tuning out these problems usually requires additional air pressure, strut damping, or both.

CHECKING FOR LEAKS

1. Inflate the air spring to 80 PSI.
2. Spray all connections and the inflation valves with a solution of 1/5 liquid dish soap and 4/5 water. Spot leaks easily by looking for bubbles in the soapy water.
3. After the test, deflate the springs to the minimum pressure required to restore the system to normal ride height.
4. Check the air pressure again after 24 hours. A 2-4 PSI loss after initial installation is normal. Retest for leaks if the loss is more than 5 lbs.

FIXING LEAKS

1. If there is a problem with a swivel fitting:
 - a. Check the air line connection by deflating the spring and removing the line by pulling the collar against the fitting and pulling firmly on the air line. Trim 1" off the end of the air line. Be sure the cut is clean and square (fig. 18). Reinsert the air line into the push-to-connect fitting.
 - b. Check the threaded connection by tightening the swivel fitting another ½ turn. If it still leaks, deflate the air spring, remove the fitting, and re-coat the threads with thread sealant. Reinstall by hand tightening as much as possible and then use a wrench for an additional two turns.
2. If the preceding steps have not resolved the problem, call Air Lift customer service at (800) 248-0892.

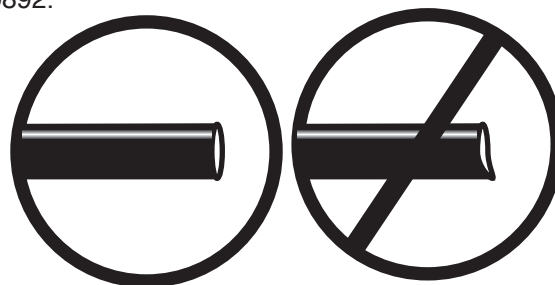
*fig. 18*

Warranty and Returns Policy

Air Lift Company warrants its performance products for one year to the original purchaser against manufacturing defects one year from the date of purchase when used on cars and trucks as specified under normal operating conditions. The warranty does not apply to products that have been improperly applied, improperly installed, or which have not been maintained in accordance with installation instructions furnished with all products. The consumer will be responsible for removing (labor charges) the defective product from the vehicle and returning it, transportation costs prepaid, to the dealer from which it was purchased or to Air Lift Company for verification.

Air Lift will repair or replace, at its option, defective products or components. A minimum \$10.00 shipping and handling charge will apply to all warranty claims. Before returning any defective product, you must call Air Lift at (800) 248-0892 in the U.S. and Canada (elsewhere, (517) 322-2144) for a Returned Materials Authorization (RMA) number. Returns can be sent to: Air Lift Company • 2727 Snow Road • Lansing, MI • 48917.

Product failures resulting from abnormal use or misuse are excluded from this warranty. The loss of use of the product, loss of time, inconvenience, commercial loss or consequential damages is not covered. The consumer is responsible for installation/reinstallation (labor charges) of the product. Air Lift Company reserves the right to change the design of any product without assuming any obligation to modify any product previously manufactured.

This warranty gives you specific legal rights and you may also have other rights that may vary from state-to-state. Some states do not allow limitations on how long an implied warranty lasts or allow the exclusion or limitation of incidental or consequential damages. The above limitation or exclusion may not apply to you. There are no warranties, expressed or implied including any implied warranties of merchantability and fitness, which extend beyond this warranty period. There are no warranties that extend beyond the description on the face hereof. Seller disclaims the implied warranty of merchantability. (Dated proof of purchase required.)

Replacement Information

If you need replacement parts, contact the local dealer or call Air Lift customer service at (800) 248-0892. Most parts are immediately available and can be shipped the same day.

Contact Air Lift Company customer service at (800) 248-0892 first if:

- Parts are missing from the kit.
- Need technical assistance on installation or operation.
- Broken or defective parts in the kit.
- Wrong parts in the kit.
- Have a warranty claim or question.

Contact the retailer where the kit was purchased:

- If it is necessary to return or exchange the kit for any reason.
- If there is a problem with shipping if shipped from the retailer.
- If there is a problem with the price.

Contact Information

If you have any questions, comments or need technical assistance contact our customer service department by calling (800) 248-0892, Monday through Friday. For calls from outside the USA or Canada, our local number is (517) 322-2144. You may also contact customer service anytime by e-mail at techsupport@airliftperformance.com.

For inquiries by mail, our address is PO Box 80167, Lansing, MI 48908-0167. Our shipping address for returns is 2727 Snow Road, Lansing, MI 48917.

You may also contact our sales team anytime by e-mail at sales@airliftperformance.com or on the web at www.airliftperformance.com.

Need Help?

Contact our customer service department by calling (800) 248-0892. For calls from outside the USA or Canada, our local number is (517) 322-2144.



Thank you for purchasing Air Lift Performance products!

Air Lift Performance • 2727 Snow Road • Lansing, MI 48917 or PO Box 80167 • Lansing, MI 48908-0167
Toll Free (800) 248-0892 • Local (517) 322-2144 • Fax (517) 322-0240 • www.airliftperformance.com

Printed in
the USA

Air Lift™
PERFORMANCE

Kit 75621

Nissan Z34 370z
Infiniti G37

Rear Application



AIR LIFT
PERFORMANCE™

INSTALLATION GUIDE

For maximum effectiveness and safety, please read these instructions completely before proceeding with installation.

Failure to read these instructions can result in an incorrect installation.

TABLE OF CONTENTS

Introduction	2
Notation Explanation	2
Important Safety Notices	2
Installation Diagram	3
Hardware List	3
Installing the Air Suspension	4
Preparing the Vehicle	4
Stock Shock and Spring Removal	4
Air Suspension Installation	5
Damping Adjustment	8
Aligning the Vehicle	8
Adjusting Extended or Drop Height Using Lower Mount	9
Before Operating	10
Installation Checklist	10
Post-installation checklist	10
Product Use, Maintenance and Servicing	11
Suggested Driving Air Pressure and Maximum Air Pressure	11
Maintenance Guidelines	11
Troubleshooting Guide	11
Frequently Asked Questions	11
Tuning the Air Pressure	12
Checking for Leaks	12
Fixing Leaks	12
Warranty and Returns Policy	13
Replacement Information	13
Contact Information	13

Introduction

The purpose of this publication is to assist with the installation, maintenance and troubleshooting of this Nissan/Infiniti Performance suspension kit.

It is important to read and understand the entire installation guide before beginning installation or performing any maintenance, service or repair. The information includes a hardware list, step-by-step installation information, maintenance tips, safety information and a troubleshooting guide.

Air Lift Company reserves the right to make changes and improvements to its products and publications at any time. For the latest version of this manual, contact Air Lift Company at (800) 248-0892 or visit our website at www.airliftperformance.com.

NOTATION EXPLANATION

Hazard notations appear in various locations in this publication. Information which is highlighted by one of these notations must be observed to help minimize risk of personal injury or possible improper installation which may render the vehicle unsafe. Notes are used to help emphasize areas of procedural importance and provide helpful suggestions. The following definitions explain the use of these notations as they appear throughout this guide.

 **DANGER**

INDICATES IMMEDIATE HAZARDS WHICH WILL RESULT IN SEVERE PERSONAL INJURY OR DEATH.

 **WARNING**

INDICATES HAZARDS OR UNSAFE PRACTICES WHICH COULD RESULT IN SEVERE PERSONAL INJURY OR DEATH.

 **CAUTION**

INDICATES HAZARDS OR UNSAFE PRACTICES WHICH COULD RESULT IN DAMAGE TO THE MACHINE OR MINOR PERSONAL INJURY.

NOTE

Indicates a procedure, practice or hint which is important to highlight.

IMPORTANT SAFETY NOTICES

The installation of this kit does not alter the Gross Vehicle Weight Rating (GVWR) or payload of the vehicle. Check your vehicle's owner's manual and do not exceed the maximum load listed for your vehicle.

Gross Vehicle Weight Rating: The maximum allowable weight of the fully loaded vehicle (including passengers and cargo). This number — along with other weight limits, as well as tire, rim size and inflation pressure data — is shown on the vehicle's Safety Compliance Certification Label.

Payload: The combined, maximum allowable weight of cargo and passengers that the vehicle is designed to carry. Payload is GVWR minus the Base Curb Weight.

 **WARNING**

DO NOT INFLATE AIR SPRINGS WHILE OFF OF THE VEHICLE. DAMAGE TO ASSEMBLY MAY RESULT AND VOID WARRANTY.

 **CAUTION**

DO NOT WELD TO, OR MODIFY STRUTS/SHOCKS IN ANY WAY. DAMAGE TO UNIT MAY OCCUR AND WILL VOID WARRANTY.

Installation Diagram

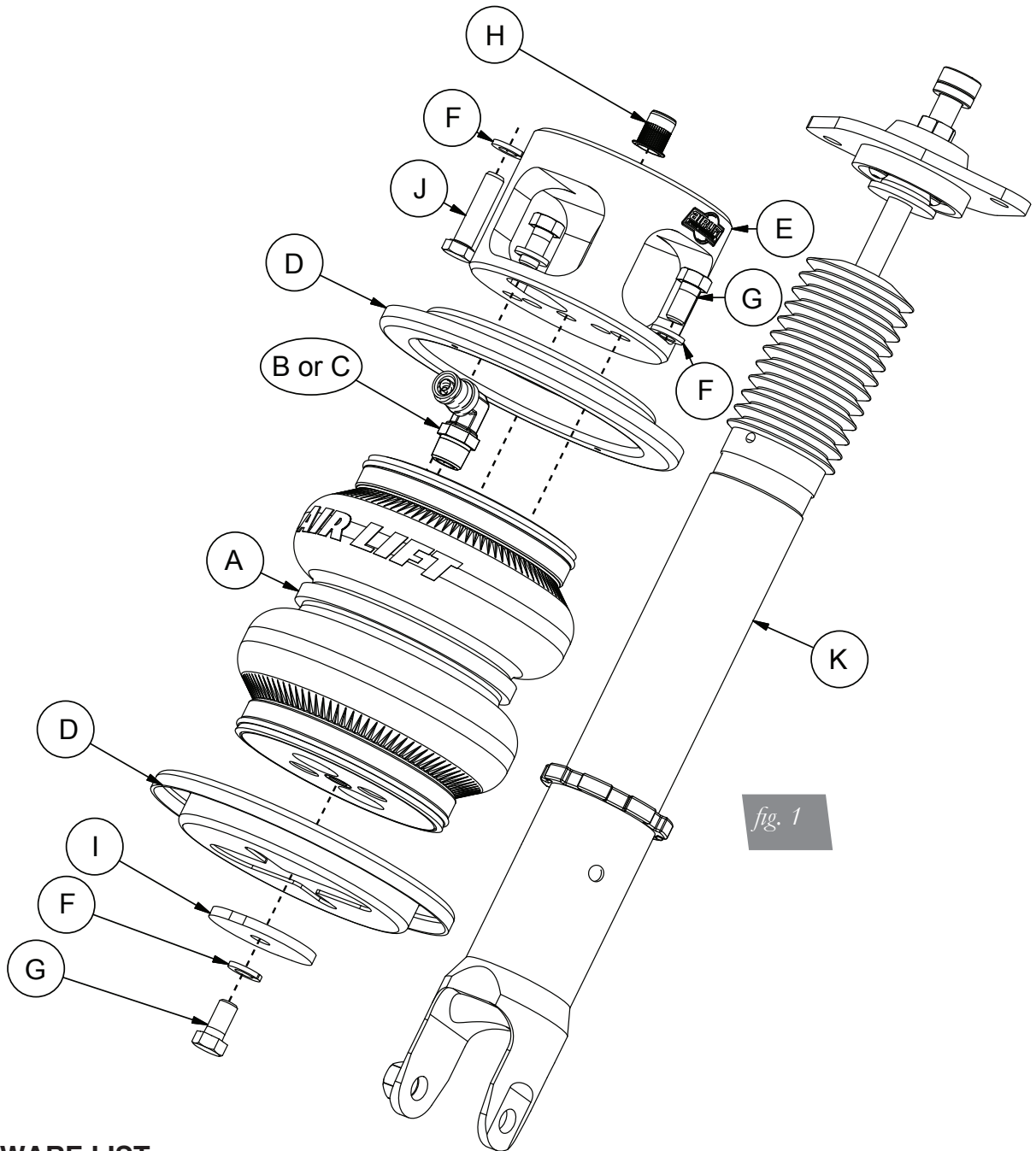

HARDWARE LIST

Item	Part #	Description.....Qty	Item	Part #	Description Qty
A	58530	Air Spring.....2	G	17203	3/8-24 X 3/4" Hex Bolt..... 6
B	21846	3/8"MNPT X 1/4"PTC, 90°..... 2	H	18585	3/8-16 Nutsert 2
C	21867	3/8"MNPT X 3/8"PTC, 90°..... 2	I	13312	Spacer, Lower Centering 2
D	11801	Roll Plate.....4	J	17108	3/8-16 X 1.5" Hex Cap Screw 2
E	13311	Spacer, Upper Air Spring 2	K	26998	Rear Shock, Nissan Z34 2
F	18427	3/8" Lock Washer 8			



Missing or damaged parts? Call Air Lift customer service at (800) 248-0892 for a replacement part.

Installing the Air Suspension

PREPARING THE VEHICLE

1. Elevate and support the vehicle with jack stands or a hoist at approved lifting points.
2. Remove the rear wheels (fig. 2).



STOCK SHOCK AND SPRING REMOVAL

1. Support the hub assembly to prevent overextension of suspension components.
2. Remove the lower shock bolt from the hub (figs. 3 & 4).



3. Remove the two upper shock bracket bolts and remove the shock from the vehicle (figs. 5 & 6).



4. Unbolt the lower control arm from the hub and slowly lower the control arm down (fig. 7).
5. Remove the coil spring and rubber isolators from the spring seats. The conical upper spring isolator snaps into place and can be removed with a side-to-side motion (fig. 8).



AIR SUSPENSION INSTALLATION

1. Using the supplied centering washer as a template, drill a 13/32" (.406" diameter) hole through the center of the lower control arm spring seat (fig. 9).

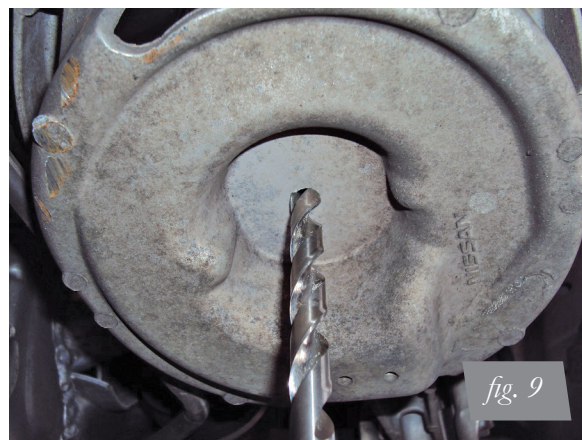

2. To install the nutsert in the upper spring seat, the upper bracket can be used as a template to center the air spring location (fig. 10). Place the bracket against the spring seat and mark the center location. Drill a hole 17/32" (.531" diameter) through the spring seat.



fig. 10

3. Assemble the nutsert and tool bolt and insert the assembly into the drilled hole. While holding the nutsert spacer in place, tighten the tool bolt until the nutsert is fully seated and locked in place (figs. 11, 12 & 13).

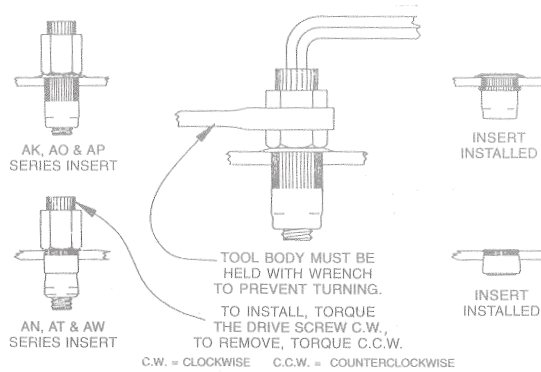

fig. 11



fig. 12



fig. 13

4. Reinstall the lower control arm to the hub. Do not torque at this time.
5. Attach the air spring upper bracket to the upper spring seat (fig. 14). Torque the upper bracket bolt (J with lock washer F) to 20Nm (15 lb-ft).

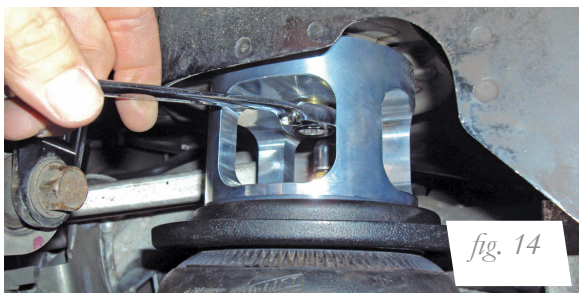
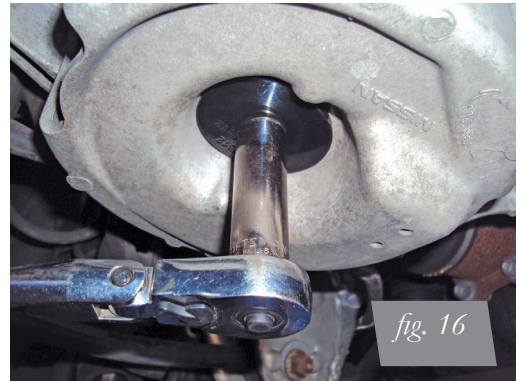
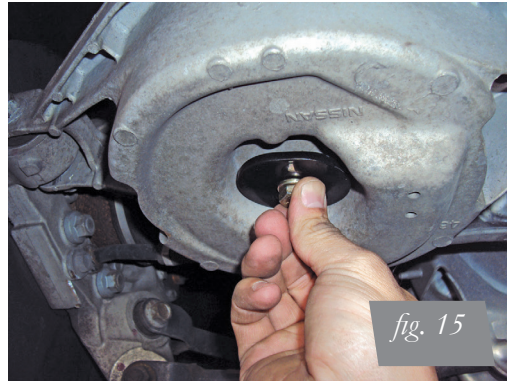

fig. 14

- Apply the roll plate underneath the air spring. Lift the upper control arm and attach the air spring assembly to the control arm with the centering spacer (I), bolt (G) and lock washer (F) through the previously drilled hole. Torque to 20 Nm (15 lb-ft). (figs. 15 & 16)



- Insert the shock assembly into the shock tower and attach the upper bracket to the chassis (fig. 17). Torque the upper bracket nuts to 28 Nm (21 lb-ft).



- Attach the shock fork to the hub. Do not torque the attaching bolt at this time.
- With the suspension fully compressed, take a measurement from the fender to some reference point – typically the center of the axle. Record this measurement as Max Compression.
- Cycle the suspension to Max Extension and record the measurement from the same reference points.
- Take the difference between the two numbers and divide by two. Add that value to the original Max Compression number. Set the suspension to this point. This position gives 50% stroke in either position and is a starting point for ride height.
- With the suspension at this position, torque the lower shock bolt and upper and lower control arm bolts to manufacturer’s specifications (Table 1).

Formula for calculating ride height (fig. 18):

Step 1:	Step 2:	Step 3:	Answer:
$\frac{ME - MC}{X}$	$\frac{X}{2} = Y$	$\frac{Y + MC}{Z}$	$Z = \text{DESIGN HEIGHT}$

fig. 18

DAMPING ADJUSTMENT

The shocks in this kit have 30 settings, or “clicks”, of adjustable compression and rebound damping characteristics. Damping is changed through the shock rod using the supplied adjuster or a 3mm allen wrench.

Turn the adjuster clockwise and the damping settings are hardened. Turn the adjuster counterclockwise and the damping is softened.

Each 370z/G37 shock is preset to “-20 clicks”. This means that the shock is adjusted 20 clicks away from full stiff. Counting down from full stiff is the preferred method of keeping track/setting of damping. This setting was developed on a 2012 Infiniti G37 sedan and may need to be adjusted to different vehicles and driving characteristics.



fig. 19

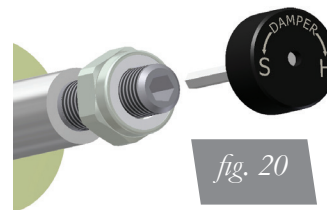

fig. 20

Torque Specifications		
Location	Nm	lb-ft
Upper bracket to chassis	20	15
Lower air spring attachment bolt	20	15
Lower control arm to hub	72.5	53
Lower control arm to sub-frame	72.5	53
Upper control arm to sub-frame	72.5	53
Trailing link to sub-frame	72.5	53
Trailing link to hub	87.5	65
Transverse link to hub	87.5	65
Transverse link to sub-frame	72.5	53
Shock lower mount to hub	123	91
Shock upper mount to chassis	28	21
Wheels	108	80

Table 1

ALIGNING THE VEHICLE

1. Using the control system, set the vehicle height to the new custom ride height.
2. If the custom ride height is lower than stock, we recommend loosening all pivot points (bolts, nuts) on any control arm, strut arm or radius rod that contains bushings (fig. 11). Once they have been loosened, re-torque to stock specifications (Table 1).

NOTE

It may be necessary to cycle the suspension to loosen the bushing up from its mount. This will help re-orient the bushing at its new position based on the custom ride height.

ADJUSTING EXTENDED OR DROP HEIGHT USING LOWER MOUNT

Your struts have been pre-set at the factory to provide maximum drop height while maintaining adequate tire clearance to the air spring. If you wish to gain more extended height (lift), which is the same as reducing drop height, or want to lower the chassis further and there is still adjustment available at the lower mount, please use the following procedure:

1. Support the vehicle with jack stands or a hoist at approved lifting points.
2. Remove the wheel.
3. Using the supplied spanner wrench, loosen the lower locking collar (fig. 21).
4. Deflate the air spring to 0 PSI on the corner you are adjusting.
5. Disconnect lower mount from suspension.
6. Spin the lower mount to the desired location.

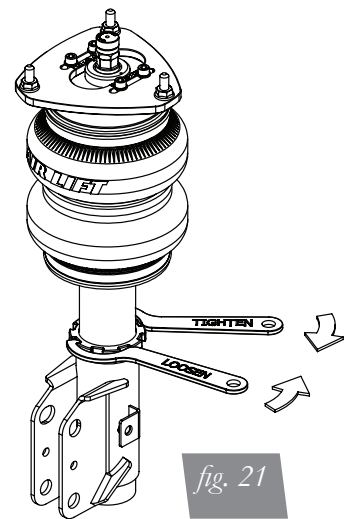

NOTE

Not all models will have further drop height available.

7. Re-install lower mount to suspension and torque fasteners.
8. Tighten the lower locking collar to the lower mount using significant force.

CAUTION

WHEN ADJUSTING HEIGHT UPWARDS, MAKE SURE THAT THE STRUT BODY ENGAGES ALL THE THREADS OF THE LOWER MOUNT (FIG. 22). WHEN ADJUSTING DOWNWARDS, MAKE SURE THERE IS ADEQUATE AIR SPRING CLEARANCE TO THE TIRE/WHEEL ASSEMBLY. CLEARANCE MUST BE CHECKED WITH SYSTEM FULLY DEFLATED AS WELL AS FULLY INFLATED TO ENSURE THAT NO RUBBING OCCURS. FAILURE TO MAINTAIN ADEQUATE CLEARANCE CAN RESULT IN AIR SPRING FAILURE AND WILL NOT BE COVERED UNDER WARRANTY.

CAUTION

DO NOT ADJUST HEIGHT BY SPINNING AIR SPRING ON STRUT! DOING SO MAY CAUSE AN AIR LEAK AND COMPROMISE THE ASSEMBLY.

FOR STRUTS:

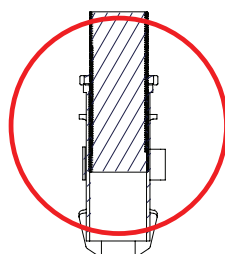
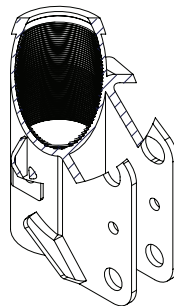

OK, no threads showing.

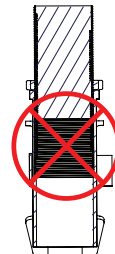

Not OK, threads are showing.

FOR SHOCKS:

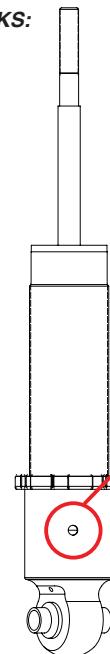

Thread **MUST** be showing in window.

fig. 22

Before Operating

CAUTION

MAKE SURE THE FRONT WHEELS ARE STRAIGHT WHEN DEFLATING AND REINFLATING AIR BAGS.

1. Inflate and deflate the system (do not exceed 125 PSI) to check for clearance or binding issues. With the air springs deflated, check clearances on everything so as not to pinch brake lines, vent tubes, etc. Clear lines if necessary.
2. Inflate the air springs to 75-90 PSI and check all connections for leaks.
3. Air Lift part #27669 AutoPilot V2 Air Management System, is highly recommended for this product.
4. Please continue by reading the Product Use, Maintenance and Servicing section.

INSTALLATION CHECKLIST

- Clearance test — Inflate the air springs to 75-90 PSI and make sure there is at least ½” clearance from anything that might rub against each sleeve. Be sure to check the tire, brake drum, frame, shock absorbers and brake cables.
- Leak test before road test — Inflate the air springs to 75-90 PSI and check all connections for leaks. All leaks must be eliminated before the vehicle is road tested.
- Heat test — Be sure there is sufficient clearance from heat sources, at least 6” for air springs and air lines. If a heat shield was included in the kit, install it. If there is no heat shield, but one is required, call Air Lift customer service at (800) 248-0892.
- Fastener test — Recheck all bolts for proper torque.
- Road test — The vehicle should be road tested after the preceding tests. Inflate the springs to recommended driving pressures. Drive the vehicle 10 miles and recheck for clearance, loose fasteners and air leaks.
- Operating instructions — If professionally installed, the installer should review the operating instructions with the owner. Be sure to provide the owner with all of the paperwork that came with the kit.

Technician's Signature _____

Date _____

POST-INSTALLATION CHECKLIST

- Overnight leak down test — Recheck air pressure after the vehicle has been used for 24 hours. If the pressure has dropped more than 5 PSI, then there is a leak that must be fixed. Either fix the leak yourself or return to the installer for service.
- Air pressure requirements — Regardless of load, the air pressure should always be adjusted to maintain adequate ride height at all times while driving.
- Thirty day or 500 mile test — Recheck the air spring system after 30 days or 500 miles, whichever comes first. If any part shows signs of rubbing or abrasion, the source should be identified and moved, if possible. If it is not possible to relocate the cause of the abrasion, the air spring may need to be remounted. If professionally installed, the installer should be consulted. Check all fasteners for tightness.

Product Use, Maintenance and Servicing

Suggested Driving Air Pressure	Maximum Air Pressure
50-70 PSI	125 PSI
FAILURE TO MAINTAIN ADEQUATE MINIMUM PRESSURE (OR PRESSURE PROPORTIONAL TO LOAD) WILL RESULT IN BOTTOMING OUT, OVER-EXTENSION OR RUBBING AGAINST ANOTHER COMPONENT AND WILL VOID THE WARRANTY.	

MAINTENANCE GUIDELINES

NOTE

By following these steps, vehicle owners will obtain the longest life and best results from their air spring.

1. Check the air pressure before driving.
2. Never inflate beyond 125 PSI.
3. If you develop an air leak in the system, use a soapy water solution to check all air line connections, before deflating and removing the spring.
4. When increasing load, always adjust the air pressure to maintain normal ride height. Increase or decrease pressure from the system as necessary to attain normal ride height for optimal ride and handling. Remember that loads carried behind the axle (including tongue loads) require more leveling force (pressure) than those carried directly over the axle.



CAUTION

FOR YOUR SAFETY AND TO PREVENT DAMAGE TO YOUR VEHICLE, DO NOT EXCEED MAXIMUM GROSS VEHICLE WEIGHT RATING (GVWR), AS INDICATED BY THE VEHICLE MANUFACTURER. ALTHOUGH YOUR AIR SPRINGS ARE RATED AT A MAXIMUM INFLATION PRESSURE OF 125 PSI, THE AIR PRESSURE ACTUALLY NEEDED IS DEPENDENT ON YOUR LOAD.

5. Always add air to the springs in small quantities, checking the pressure frequently. Sleeves require less air volume than a tire and inflate quickly.
6. Should it become necessary to raise the vehicle by the frame, make sure the control system is turned off before lifting.

TROUBLESHOOTING GUIDE

1. Leak test the air line connections, the threaded connection into the air spring, and all fittings in the control system.
2. Inspect the air lines to be sure none are pinched. Tie straps may be too tight. Loosen or replace the strap and replace leaking components.
3. Inspect the air line for holes and cracks. Replace as needed.
4. Look for a kink or fold in the air line. Reroute as needed.

If the preceding steps do not solve the problem, it is possibly caused by a failed air spring — either a factory defect or an operating problem. Please call Air Lift at (800) 248-0892 for assistance.

FREQUENTLY ASKED QUESTIONS

Q. Will installing air springs increase the weight ratings of a vehicle?

No. Adding air springs will not change the weight ratings (GAWR, GCWR and/or GVWR) of a vehicle. Exceeding the GVWR is dangerous and voids the Air Lift warranty.

Q. How long should air springs last?

If the air springs are properly installed and maintained they can last indefinitely.

Q. Will raising the vehicle on a hoist for service work damage the air springs?

No. The vehicle can be lifted on a hoist for short-term service work such as tire rotation or oil changes. However, if the vehicle will be on the hoist for a prolonged period of time, support the axle with jack stands in order to take the tension off of the air springs.

TUNING THE AIR PRESSURE

Pressure determination comes down to three things — level vehicle, ride comfort, and stability.

1. Level vehicle

If the vehicle's headlights are shining into the trees or the vehicle is leaning to one side, then it is not level. Raise the air pressure to correct either of these problems and level the vehicle.

2. Ride comfort

If the vehicle has a rough or harsh ride it may be due to either too much pressure or not enough. Try different pressures to determine the best ride comfort. See Air Lift suggested driving air pressure.

3. Stability

Stability translates into safety and should be the priority, meaning the driver may need to sacrifice a perfectly level and comfortable ride. Stability issues include roll control, bounce, dive during braking and sponginess. Tuning out these problems usually requires additional air pressure, strut damping, or both.

CHECKING FOR LEAKS

1. Inflate the air spring to 80 PSI.
2. Spray all connections and the inflation valves with a solution of 1/5 liquid dish soap and 4/5 water. Spot leaks easily by looking for bubbles in the soapy water.
3. After the test, deflate the springs to the minimum pressure required to restore the system to normal ride height.
4. Check the air pressure again after 24 hours. A 2-4 PSI loss after initial installation is normal. Retest for leaks if the loss is more than 5 lbs.

FIXING LEAKS

1. If there is a problem with a swivel fitting:
 - a. Check the air line connection by deflating the spring and removing the line by pulling the collar against the fitting and pulling firmly on the air line. Trim 1" off the end of the air line. Be sure the cut is clean and square (see fig. 23). Reinsert the air line into the push-to-connect fitting.
 - b. Check the threaded connection by tightening the swivel fitting another ½ turn. If it still leaks, deflate the air spring, remove the fitting, and re-coat the threads with thread sealant. Reinstall by hand tightening as much as possible and then use a wrench for an additional two turns.
2. If the preceding steps have not resolved the problem, call Air Lift customer service at (800) 248-0892.

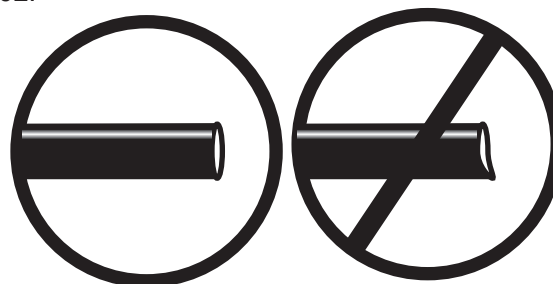
*fig. 23*

Warranty and Returns Policy

Air Lift Company warrants its performance products for one year to the original purchaser against manufacturing defects one year from the date of purchase when used on cars and trucks as specified under normal operating conditions. The warranty does not apply to products that have been improperly applied, improperly installed, or which have not been maintained in accordance with installation instructions furnished with all products. The consumer will be responsible for removing (labor charges) the defective product from the vehicle and returning it, transportation costs prepaid, to the dealer from which it was purchased or to Air Lift Company for verification.

Air Lift will repair or replace, at its option, defective products or components. A minimum \$10.00 shipping and handling charge will apply to all warranty claims. Before returning any defective product, you must call Air Lift at (800) 248-0892 in the U.S. and Canada (elsewhere, (517) 322-2144) for a Returned Materials Authorization (RMA) number. Returns to Air Lift can be sent to: Air Lift Company • 2727 Snow Road • Lansing, MI • 48917.

Product failures resulting from abnormal use or misuse are excluded from this warranty. The loss of use of the product, loss of time, inconvenience, commercial loss or consequential damages is not covered. The consumer is responsible for installation/reinstallation (labor charges) of the product. Air Lift Company reserves the right to change the design of any product without assuming any obligation to modify any product previously manufactured.

This warranty gives you specific legal rights and you may also have other rights that may vary from state-to-state. Some states do not allow limitations on how long an implied warranty lasts or allow the exclusion or limitation of incidental or consequential damages. The above limitation or exclusion may not apply to you. There are no warranties, expressed or implied including any implied warranties of merchantability and fitness, which extend beyond this warranty period. There are no warranties that extend beyond the description on the face hereof. Seller disclaims the implied warranty of merchantability. (Dated proof of purchase required.)

Replacement Information

If you need replacement parts, contact the local dealer or call Air Lift customer service at (800) 248-0892. Most parts are immediately available and can be shipped the same day.

Contact Air Lift Company customer service at (800) 248-0892 first if:

- Parts are missing from the kit.
- Need technical assistance on installation or operation.
- Broken or defective parts in the kit.
- Wrong parts in the kit.
- Have a warranty claim or question.

Contact the retailer where the kit was purchased:

- If it is necessary to return or exchange the kit for any reason.
- If there is a problem with shipping if shipped from the retailer.
- If there is a problem with the price.

Contact Information

If you have any questions, comments or need technical assistance contact our customer service department by calling (800) 248-0892, Monday through Friday. For calls from outside the USA or Canada, our local number is (517) 322-2144. You may also contact customer service anytime by e-mail at techsupport@airliftperformance.com.

For inquiries by mail, our address is PO Box 80167, Lansing, MI 48908-0167. Our shipping address for returns is 2727 Snow Road, Lansing, MI 48917.

You may also contact our sales team anytime by e-mail at sales@airliftperformance.com or on the web at www.airliftperformance.com.

Need Help?

Contact our customer service department by calling (800) 248-0892. For calls from outside the USA or Canada, our local number is (517) 322-2144.



Thank you for purchasing Air Lift Performance products!

Air Lift Performance • 2727 Snow Road • Lansing, MI 48917 or PO Box 80167 • Lansing, MI 48908-0167
Toll Free (800) 248-0892 • Local (517) 322-2144 • Fax (517) 322-0240 • www.airliftperformance.com

Printed in
the USA

Kit Details

27669



HARDWARE LIST

Part #	Description	Qty	Part #	Description	Qty
72604	4pt Fast Air Manifold - 3/8"	1	20946	DOT 1/4" Air Line	2ft
27042	Gen 3 Display	1	21585	1/4" Pipe Plug	1
26498-002	Electrical Harness - FastAir	1	21737	3/8" Pipe Plug	1
20937	Polyurethane Filter Drain Hose	5ft	21773	3/8" MNPT X 1/8" MNPT Adapter	1
20947	DOT 3/8" Air Line	60ft	21854	1/8" MNPT X 3/8" PTC Elbow	2
24672	Fuse, spade 3amp	1	21855	3/8" MNPT X 3/8" PTC Elbow	1
24547	Fuse, spade, 30amp	1	18444	3/8" Flat Washer	8
24500	ATC Fuse holder w/ cap	2	17188	3/8-16 x 1.25 Hex Cap Screw	4
24645	16GA Butt Connector	1	17263	1/4-14 x 1 Self Tapping Screw	3
24752	12-10GA Butt Connector	3	18435	3/8-16 Nyloc Nut	4
24748	12GA Ring Terminal 3/8"	2	11517	Miniature Filter	1
24524	Female Spade Terminal	1	11217	P Clamp	1
24595	12GA Female Spade Terminal	1	17173	1/4"-14 X 3/4" Self Tapping Screw	1
24561	Adaptor, Mini Fuse	1	16380	VIAIR 380C Compressor (200 psi)	1
24542	ATC/ATO Fuse Adaptor	1	11955	4 Gallon Aluminum Air Tank	1
23586	Thread Sealant	1	10466	8" Zip Tie	10
21043	1/4" MNPT X 1/4" PTC Elbow	1	10530	Air Line Cutter	1
21633	Push Lock Valve	1			



Missing or damaged parts? Call Air Lift customer service at (800) 248-0892 for a replacement part.

Air Lift™ PERFORMANCE

AutoPilot V2™

PATENT PENDING



AIR LIFT **PERFORMANCE**™

INSTALLATION GUIDE

For maximum effectiveness and safety, please read these instructions completely before proceeding with installation.

Failure to read these instructions can result in an incorrect installation.



TABLE OF CONTENTS

Introduction	2
Notation Explanation	2
Installing the AutoPilot V2 Kit	3
Install Components	3
Install Harness	4
Install Air Lines	5
NPT Assembly Instructions	6
Helpful Tips: Air Line and Fittings	6
Setup and Calibration	6
System Calibration and Settings	7
Program Presets	9
Operating the System	12
Troubleshooting Guide	13
Leak Testing and Detection	13
Electrical Schematic	14
AutoPilot V2 Remote Control Unit Dimensions	15
Manifold Template	17
16380 Compressor Template	19
Warranty and Returns Policy	21
Replacement Information	21
Contact Information	21



Introduction

The purpose of this publication is to assist with the installation, operation and troubleshooting of the AutoPilot V2 kit.

It is important to read and understand the entire installation guide before beginning installation or performing any maintenance, service or repair. The information includes step-by-step installation information, installation templates and a troubleshooting guide.

Air Lift Company reserves the right to make changes and improvements to its products and publications at any time. For the latest version of this manual, contact Air Lift Performance at (800) 248-0892 or visit our website at www.airliftperformance.com.

NOTATION EXPLANATION

Hazard notations appear in various locations in this publication. Information which is highlighted by one of these notations must be observed to help minimize risk of personal injury or possible improper installation which may render the vehicle unsafe. Notes are used to help emphasize areas of procedural importance and provide helpful suggestions. The following definitions explain the use of these notations as they appear throughout this guide.

 **DANGER**

INDICATES IMMEDIATE HAZARDS WHICH WILL RESULT IN SEVERE PERSONAL INJURY OR DEATH.

 **WARNING**

INDICATES HAZARDS OR UNSAFE PRACTICES WHICH COULD RESULT IN SEVERE PERSONAL INJURY OR DEATH.

 **CAUTION**

INDICATES HAZARDS OR UNSAFE PRACTICES WHICH COULD RESULT IN DAMAGE TO THE MACHINE OR MINOR PERSONAL INJURY.

NOTE

Indicates a procedure, practice or hint which is important to highlight.

Installing the AutoPilot V2 Kit

INSTALL COMPONENTS

NOTE

For a complete schematic, please see fig. 15. (pages 10-11)

CAUTION

BEST PRACTICE IS TO LOCATE THE MANIFOLD UNIT INSIDE THE VEHICLE. IF EXTERNAL MOUNTING IS DESIRED, THE MANIFOLD MUST BE LOCATED IN AN AREA SHIELDED FROM DIRECT WATER SPRAY FROM TIRES OR CAR WASHES. THE MANIFOLD SHOULD BE CONSIDERED “WATER RESISTANT” NOT “WATERPROOF”.

Layout

1. Plan component location first. Ideally, the manifold should be located above the compressor and tank if possible to avoid compressor ingested water from gathering in the manifold. This is most important for vehicles operated in below freezing climates.
2. Prior to mounting components, check to make sure:
 - the electrical harness connections will reach the manifold and compressor.
 - the compressor leader hose will reach the tank.
 - the air lines will route cleanly through the vehicle without kinking or bending.

NOTE

Be sure to install all components as far as possible from any heat sources. Plan and prepare harness and air line routing thru the vehicle. Eliminate all sharp edges that could chafe. Use grommets when passing through compartment walls.

Prepare and install the compressor

1. Prepare the compressor intake. If the compressor body is mounted inside the vehicle, attach filter to port on end of compressor (fig. 15). If compressor is located outside the vehicle, snorkel inlet filter to dry location inside vehicle using components supplied with compressor.
2. Center punch and drill four holes using the template on page 19.
3. Attach using the hardware supplied with the compressor.

NOTE

If the harness must be lengthened, use properly sized butt connectors and wire. If extending the power/ground wires, use 8AWG wire minimum or contact Air Lift for more information.

The supplied harness is only capable of powering a single compressor. If installing dual compressors, a second dedicated power wire is required. Consult the Electrical Schematic section for proper wiring, and contact Air Lift for an optional second compressor harness (part number: 27679).

Manifold

1. Position the manifold in a desired location. Make sure the manifold mounting surface is flat.

NOTE

Mount the manifold to the body either horizontally (fig. 1a) or vertically with the ports facing toward the ground (fig. 1b). Do not mount the manifold upside down (fig. 1c). Proper manifold mounting will help prevent water from settling in areas sensitive to freezing.

2. Fasten the manifold using the two self-tapping screws. **If the mounting surface is not flat, add washers to space the manifold up over surface irregularities.**
3. If needed, a manifold mounting template can be found on page 17.

This represents the top of the vehicle frame or any custom setup (and is the same for figures 1b and 1c).

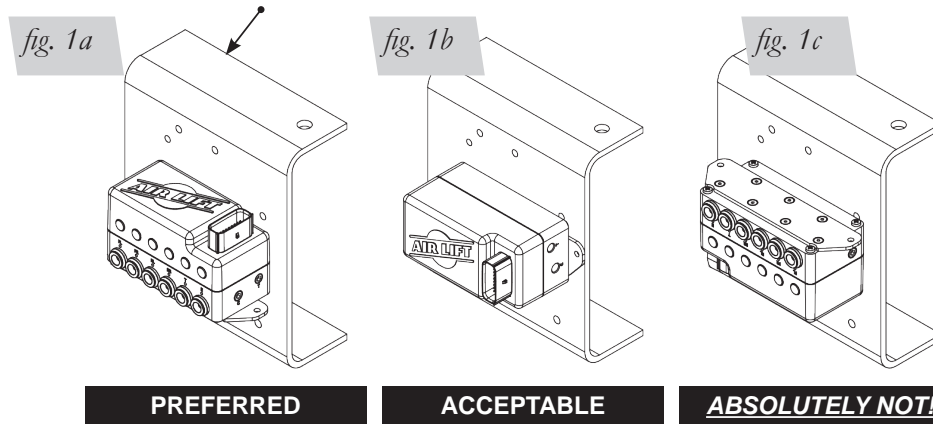

NOTE

Air compressors intake moisture (humidity) from the outside air source and will deposit water in the air tank. The AutoPilot V2 system includes a filter that will greatly reduce the potential for moisture to enter the manifold, however, tanks must be regularly purged to eliminate the possibility of water entering the manifold. Be sure to provide easy access to tank drain/fill valve (preferably outside the vehicle). This is an automatic draining filter and does not need servicing. If you find this filter to be plugged, it will need to be replaced. If using an engine driven compressor, the life of the provided filter may be reduced due to the increased potential for oil being introduced into the system.

Tank pre-assembly (see fig. 15)

1. Per the diagram on pages 10 and 11, install the filter to the tank with supplied fittings/adapters or remotely mount the filter using the supplied fittings, P-clamp and self tapping screw. Be sure to mount the filter in the correct orientation.

NOTE

This is a one-way filter. The arrow at the top should be pointing in the direction of the air flow from the tank to the manifold (fig. 15b).

This is an automatic draining filter that does not require servicing. If you find this filter to be plugged, it will need to be replaced. The tank will need to be purged periodically to reduce/eliminate the potential of moisture entering the manifold.

Tank install (see fig. 15)

1. Using the tank feet as a template, drill holes for hardware assembly.
2. Attach the tank using the supplied hardware.
3. Cut an appropriate length of hose from the manifold port T, to the PTC fitting on the filter.
4. Route the drain/fill air line with a schrader valve (preferably outside the vehicle).
5. Install the supplied drain tube (soft hose) to the bottom of the filter and route to a location outside of the vehicle.

NOTE

When cutting plastic air line, only use a standard hose cutter like (Air Lift part number 10530) or razorblade. Cut all hose ends square and as smoothly as possible. See hose cutting tips on page 6.

INSTALL HARNESS

1. Disconnect the battery ground while installing the system.
2. Compressor / manifold connections (see fig. 15)
 - Attach the manifold connector, it will “click” into place once fully seated.
 - Mount the compressor relay in a preferred location using a self-tapping screw.
 - Cut off the spade and eyelet from the compressor power and ground wires.
 - Strip 1/4” of wire casing from the compressor wires.
 - Strip 1/4” of wire casing from the black and pink harness wires.
 - NOTE: Use an appropriate terminal crimp tool to ensure a good connection.

- Using a butt connector attach the RED compressor wire to the PINK harness wire.
 - Using a butt connector attach the BLACK compressor wire to the BLACK harness wire.
 - Carefully apply heat (preferably with a heat gun) to seal these connections.
3. Battery / ignition connections (see fig. 15)
 - Identify the power, ground, + ignition leg of the harness.
 - Ground: 10AWG black wire; Power: 10AWG red wire; Ignition: 18AWG pink wire.
 - Route power and ground leg of the harness free from any heat source to the battery.
 - Using a butt connector attach the red wire to a fuse holder.
 - Attach an 3/8" eyelet to the other end of the fuse holder and attach to the positive battery (+) terminal.
 - Attach an 3/8" eyelet to the black wire and attach to the battery ground.
 - Route the 18AWG pink wire to a key switched IGNITION source that remains on during cranking. Examples include: ECU, fuel pump.

NOTE

Do not select an accessory source. If the AutoPilot V2 display shuts off while starting the vehicle, this is not a true ignition source.

- Using a butt connector attach the pink ignition wire to a fuse holder.
 - Select ignition source and attach the fused ignition wire.
 - Use fuse adaptors as necessary.
4. Display
 - Route the display cable as desired to the preferred operating location.
 - Attach the display cable to the main harness cable (small white 3 cavity connector).
 5. Reconnect the battery.

INSTALL AIR LINES

NOTE

Use a standard hose cutter (Air Lift part number 10530) or razorblade. Cut all hose ends square and as smoothly as possible.

1. Route and attach the air lines to the air springs.
 - Route air lines free from abrasive edges and heat sources.
2. Attach manifold port **FL** to the front, drivers side left spring.
3. Attach manifold port **FR** to the front, passengers side right spring.
4. Attach manifold port **RL** to the rear, drivers side left spring.
5. Attach manifold port **RR** to the rear, passengers side right spring.
6. Attach manifold port **T** to the PTC fitting previously installed on the filter.
7. Manifold port **E** is the exhaust port.
 - Port E can be left open, or routed to a preferred exhaust location.

NOTE

Air lines should be pushed in firmly, with a slight back and forth rotational twist – check the connection by pulling on each line to verify a robust connection.

Release the air line from the fitting by releasing air, pushing on the line, depressing the ring towards the fitting, and then pulling the hose out of the fitting.

NPT ASSEMBLY INSTRUCTIONS

1. Inspect the port and fitting ensuring both are free of contaminants and excessive burrs and nicks.
2. Apply a stripe of liquid pipe sealant around the male threads leaving the first two threads uncovered.
3. Screw finger tight into the port.
4. Wrench tighten the fitting to the correct turns past finger tight position (see table 1 located on page 6).



CAUTION

NEVER BACK OFF AN INSTALLED PIPE FITTING TO ACHIEVE PROPER ALIGNMENT. LOOSENING INSTALLED PIPE FITTINGS WILL CORRUPT THE SEAL AND CONTRIBUTE TO LEAKAGE AND FAILURE.

Torque Specifications		
Fitting Size	Turns Past Finger Tight	Torque lb/ft
1/8" NPT	1.5 - 3.0	12
1/4" NPT	1.5 - 3.0	25
3/8" NPT	1.5 - 3.0	40
1/2" NPT	1.5 - 3.0	54
3/4" NPT	1.5 - 3.0	78
1" NPT	1 - 2.5	112
1 1/4" NPT	1 - 2.5	154
1 1/2" NPT	1 - 2.5	211
2" NPT	1 - 2.5	300

Table 1

HELPFUL TIPS: AIR LINE AND FITTINGS

1. Minimum hose bend radius
 - 3/8" hose = 1.5" hose bend radius.
 - 1/4" hose = 1" hose bend radius.
2. Hose to fitting
 - No side loading on fitting from hose.
 - Hose straight for 1" before bending.
3. Hose cutting
 - Cut hose perpendicular to hose length.
 - Inspect hose for scratches that run lengthwise on hose prior to insertion.
 - Use proper hose cutter, cigar cutter, or razor on flat surface.
4. DOT/SAEJ844 air brake hose data
 - Maximum working pressure of 175 PSI.
 - Not to be used for frame (body) to un-sprung mass connection, use a braided leader hose for this moving connection.

Compressor Tank Pressure		
Viair	Air Lift P/N	Max. Tank Pressure
380C	16380	175
400C	16400	150
444C	16444	175
450C	16450	150
480C	16480	175

Table 2

Setup and Calibration

AutoPilot V2 is an advanced pressure-based air suspension control system, that uses state-of-the-art software algorithms to calibrate or map the control system to your vehicle. Once the system is calibrated, the algorithm predicts required "valve open time" to move the air suspension to achieve preset target pressures. AutoPilot V2 has 8 programmable presets, allowing the user to input 8 different combinations of the 4 corner air spring pressures.

After installing AutoPilot V2 in your vehicle, please follow the steps below to properly setup your new system. If changes are made after installing and calibrating the system such as changes to air springs, lines, tank, compressor, or other vehicle modifications, the system must be recalibrated to maintain accuracy.

SYSTEM CALIBRATION AND SETTINGS

1. Key-on/power up, and compressor should come on to fill the tank. Check to make sure system is triggered by IGNITION source. While starting the engine, the system should be ON. If not, please refer back to the “Install Harness” section.
2. Press buttons 1 and 5 simultaneously (1+5) and hold for 5-10 seconds until settings and diagnostics mode main page appears (fig. 3).

fig. 2

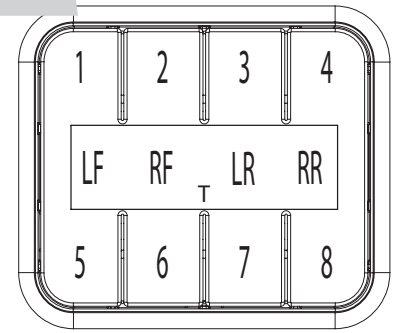

Button Definition

Tank Adjust (Maximum System PSI)

Press button 1 (TANK ADJUST). Set tank pressure preference by pressing MAX up/down buttons simultaneously (fig. 4). The MAX value sets compressor cut-off pressure. Press buttons (1+5) simultaneously to exit to settings and diagnostics mode.

fig. 3

1. TANK ADJUST
 2. CALIBRATE
 3. BACKLIGHT
 4. PRESET MAIN ▾

NOTE

MIN tank pressure will follow MAX within 15 PSI to provide further accuracy.

If tank MAX settings are changed, a system recalibration is necessary for optimal performance. Max tank pressures for various compressors can be found in table 2.

fig. 4

△
 TANK MAX=175
 ▾

Calibrate to your vehicle

Press button 2 to enter CALIBRATE (fig. 3). Press button 1 SYSTEM CAL (fig. 5), follow instructions to calibrate AutoPilot V2 system to your vehicle. Once calibration is complete, Press buttons (1+5) simultaneously to exit to settings and diagnostics mode.

fig. 5

CALIBRATION MENU
 1. SYSTEM CAL
 2. ADJUST SYSTEM

CAUTION

DURING CALIBRATION THE SYSTEM WILL AUTOMATICALLY DEFLATE TO 0 PSI AND RAISE TO 100 PSI ON EACH AXLE AUTOMATICALLY. IF WHEELS EXTEND BEYOND FENDERS, VEHICLE DAMAGE MAY RESULT. CALIBRATION ON NARROW WHEELS THAT TUCK INSIDE THE FENDERS IS RECOMMENDED. ALSO, MAKE SURE VEHICLE BODYWORK WILL NOT BE HARMED IF ONE END IS RAISED TO 100 PSI AND THE OTHER IS AT ZERO. IF DAMAGE IS POSSIBLE, IT MAY BE BEST TO CALIBRATE BY SETTING VEHICLE ON BLOCKS OF WOOD (SAME HEIGHT) TO GIVE THE BODYWORK MORE CLEARANCE.

Backlight Setting

Press button 3 to enter BACKLIGHT (fig. 3). Set display backlight to your preference by pressing the + and – on R (Red), G (Green), B (Blue) (fig. 6). Press buttons (1+5) simultaneously to exit to settings and diagnostics mode.

fig. 6

+ + +
 BACKLIGHT
 R G B
 - - -

Automatic Preset Maintenance

Press button 4 (fig. 3) to enter PRESET MAINTAIN. Press button 8 to turn ON or OFF (fig. 7). When ON, this function actively monitors air spring pressure and fills to maintain active preset pressure when average pressure drops below a threshold due to a system leak.

fig. 7



NOTE

This function will not exhaust pressure. If air spring pressure is higher than preset target, only the operator pressing the preset button again will activate the system to exhaust air spring pressure (for safety). Press buttons (1+5) simultaneously to exit.

PRESET MAINTAIN should be off for performance/track driving or if operating in extremely hilly areas.

Compressor Test / Run Time

Press button 5 to run a compressor test (fig. 8). This function will exhaust the tank to the specified MIN tank pressure, then turn ON the compressor and measure its inflate time to achieve MAX pressure (fig. 9). AutoPilot V2 will record this fill time, allowing the operator to compare future fill times to determine compressor performance. Press buttons (1+5) simultaneously to exit. Press button 6 (fig. 8) to view the number of hours the compressor has been running.

fig. 8

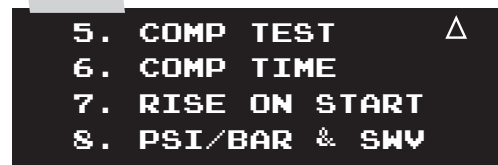
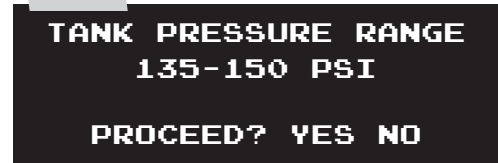

fig. 9



Rise on Start

Press button 7 (fig. 8) to enter RISE ON START (fig. 10). This function will automatically activate valves to achieve preset 1 target pressures when the vehicle is keyed-on. This function allows the operator to drive away seconds after vehicle is started. Press buttons (1+5) simultaneously to exit.

fig. 10

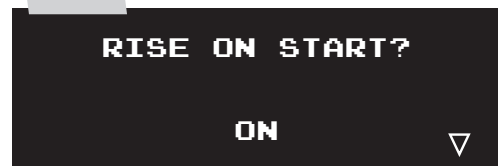

NOTE

This function only operates when the start-up pressures are BELOW the Preset 1 target pressures. The system will not deflate to achieve Preset 1 target

Set Units (PSI / BAR)

1. Press button 8 (fig. 8) to toggle between PSI and BAR pressure units and check software version. Press buttons (1+5) simultaneously to exit.
2. Press buttons (1+5) simultaneously to exit settings and diagnostics – you are now ready to create presets!

NOTE

BAR stands for DeciBar values.

Program Presets

Program Preset 1

NOTE

Preset 1 should always be entered as the desired ride pressure for the RISE ON START function.

Determine desired ride pressures: press buttons (1+5) simultaneously to toggle display to MANUAL mode. Manually activate each corner (see MANUAL mode section page 13) to achieve desired “normal driving” ride pressure (fig. 11). Program preset 1: press buttons (1+5) simultaneously to toggle display to PRESET mode (fig. 12). Press and hold button 1 for 3 seconds to set preset 1. Release button and actual air spring pressures will appear (fig. 12). Fine-tune the pressures by pressing up/down buttons. Press and hold to scroll. Press buttons (1+5) simultaneously to save and exit.

Program Presets 2-8

You are now free to program the additional 7 presets to desired pressures. Typical presets can be:

- “Low”: set pressures to the lowest possible pressures for extreme low driving stance.
- “Front up”: for speed bump or driveway clearance.
- “Rear up”: for added load of passengers, equipment.
- “Play”: for those that want to enjoy their air suspension freedom, AutoPilot V2 has a special function that recognizes side-to-side presets. When left side pressures are equal, and right side pressures are equal but >25PSI different than left, the algorithm will activate side to side instead of front to back. It will also equalize all air spring pressures when exiting the “play” preset, conserving air by using the high pressure side to inflate the low pressure side. Pairing two “play” presets together allows side-to-side activation that consumes far less air than manual mode activation would consume.

fig. 2

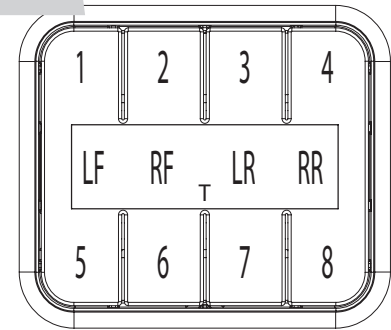

Button Definition

fig. 11



fig. 12

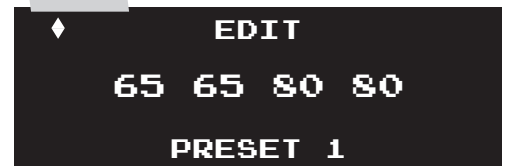
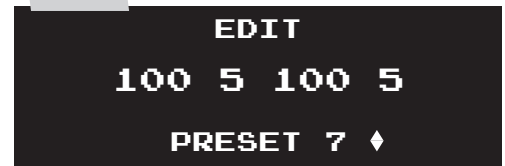

fig. 13



fig. 14



Sample Pressure Layouts for Play Mode (figs. 13 & 14)

fig. 15

Connect direct to battery

Preferred

NOTE: If not run to battery, voltage drop may reduce system performance and durability.

Ignition Source (on while cranking)

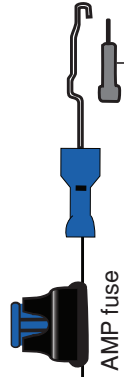

Examples:

- ECU • Fuel pump • etc.

Relay schematic reference

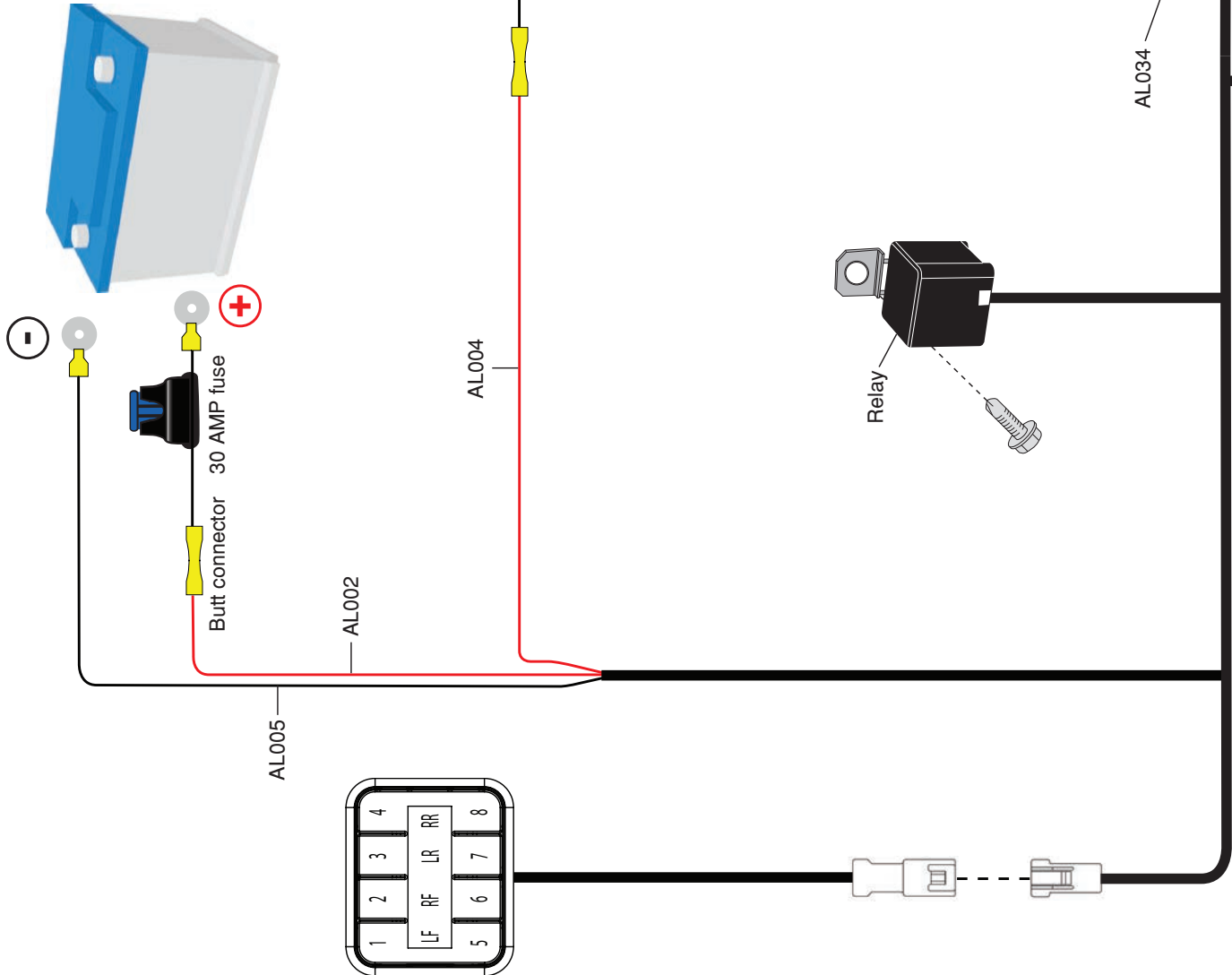
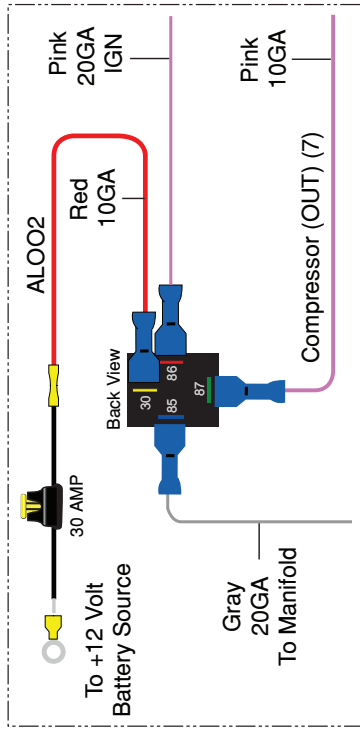

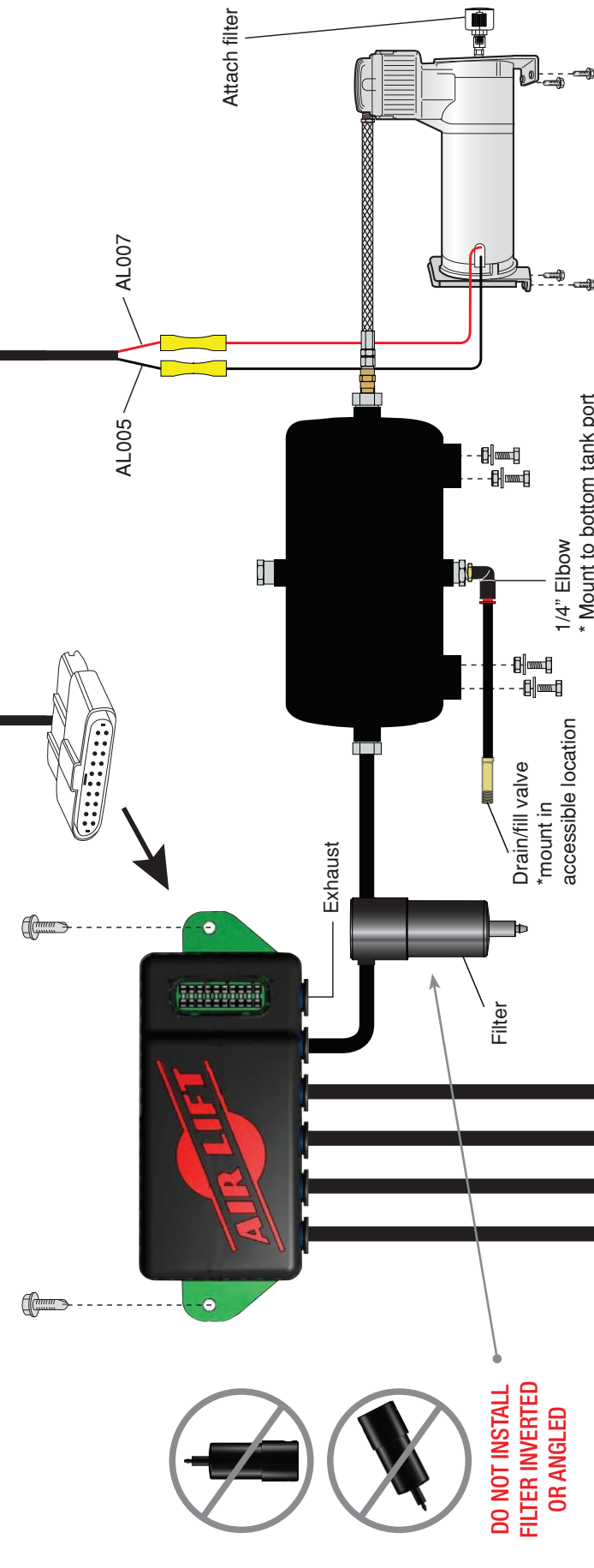

FILTER INSTALLATION OPTIONS

OPTION #1 - INSTALL TO TANK

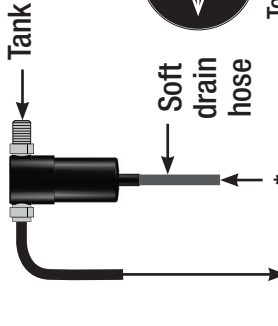

OPTION #2 - REMOTELY MOUNT**

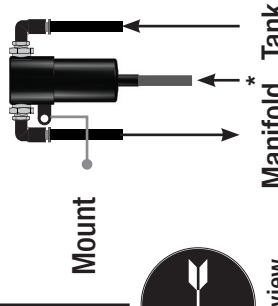
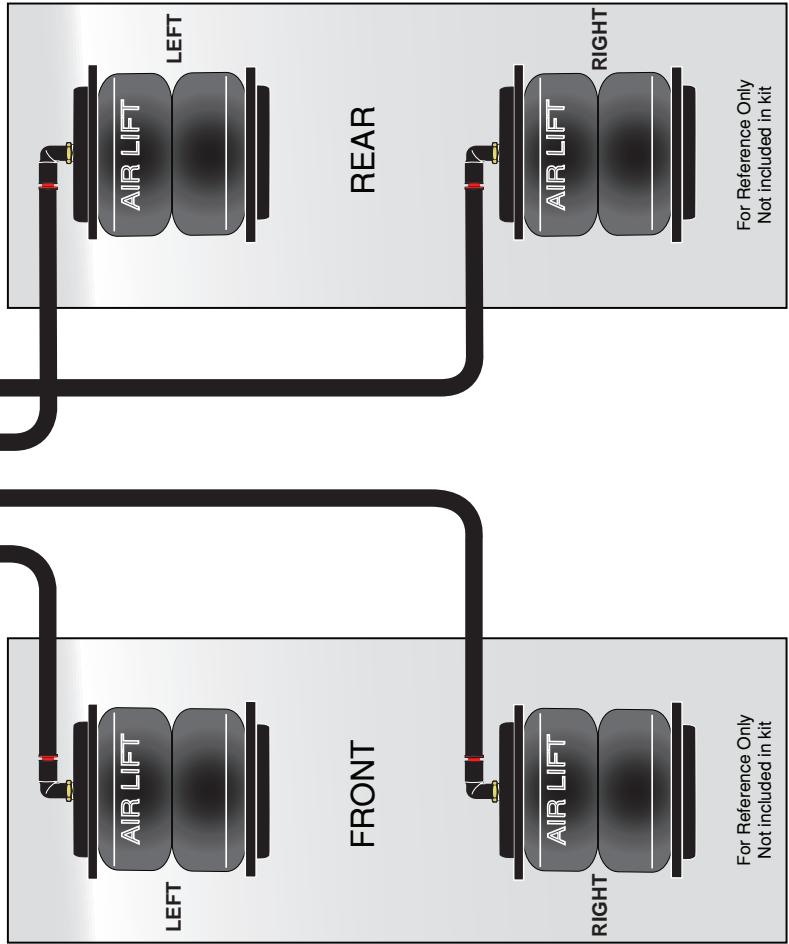

fig. 15b

Manifold Tank

**This option must be used for tank P/N 10995

*This is a moisture drain and must drain to the outside of the vehicle.



AIR LINE CUTTING

NOTE: Air Lift recommends using a hose cutting tool to ensure a proper cut (Air Lift part number 10530). If a hose connection has been disconnected the hose must be trimmed 1/2" back to provide for a leak free seal.

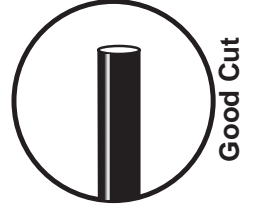

Operating the System

Now that your system is set up, it's time to use it. If changes are made after installing and calibrating the system such as changes to air springs, lines, tank, or compressor, the system must be recalibrated to maintain system accuracy.

There are two operational modes: PRESET and MANUAL. Pressing buttons (1+5) simultaneously will toggle between modes. After 10 seconds of non-use, the display enters standby where the LCD dims. Any button hit will "wake-up" the display and allow users to activate the system. See mode operation below for more details.

PRESET Mode

1. If display is sleeping, press any button once to "wake up" the display. If display is illuminated, go to the next step. Press of any button will display the programmed preset pressures for that button. Users can quickly view each preset prior to activating to make sure they are selecting the desired preset.
2. A 2nd button press of the same preset button within 2 seconds will activate it. The system will iterate up to 6 times to achieve the preset target pressures by +/- 3 PSI. The display shows PLEASE WAIT as it iterates, then will flash SUCCESSFUL when achieved or UNSUCCESSFUL if not able to achieve the target pressure window.
3. Micro adjust to ±1 PSI: If more accuracy is desired, double press the same preset and the system will refine pressures closer to target. This is often necessary when target preset pressures are LOWER than current pressure. Accuracy can be improved by rolling the vehicle straight while activating the preset.

NOTE

If the system indicates UNSUCCESSFUL, refer to troubleshooting guide on page 13.

PRESET Mode: Improve Accuracy

If system reads SUCCESSFUL but pressures are consistently lower or higher than target, you can improve first attempt accuracy by going to Calibration Menu (fig. 5) and pressing button 2. Adjust the ADJ value to a higher number if first attempt pressures are lower than target. Adjust the value to a lower number if first attempt pressures are higher than target.

CAUTION

WHEN A PRESET IS ACTIVATED THAT LOWERS THE VEHICLE SIGNIFICANTLY BELOW DRIVING HEIGHT, BE SURE TO HAVE THE FRONT WHEELS STEERED STRAIGHT AHEAD TO AVOID FENDER TO TIRE DAMAGE!

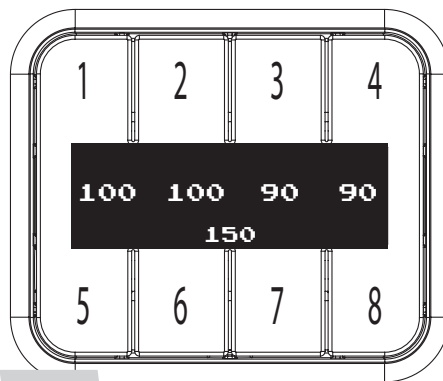

fig. 16

PRESET Mode

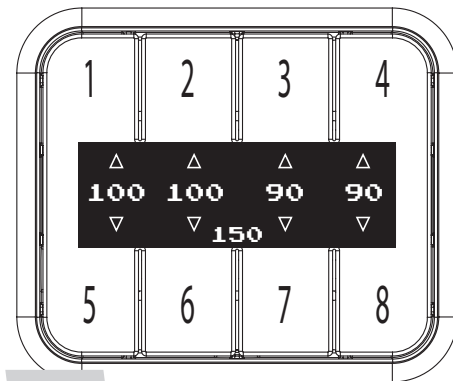

fig. 17

MANUAL Mode

MANUAL Mode

1. MANUAL mode allows the user to fill or exhaust each spring independently. The display will show arrows above and below the pressures to indicate manual control mode (fig. 17). The arrow will be solid when the spring is filling/exhausting, and outlined when not active.
2. The system detects button press time. For a very short (<0.1sec) duration press, the system will open the valves for a defined “burst”, changing pressure minimally so users can fine-tune their pressures. For a longer than 0.1 sec duration press, the valves open as long as you hold the button down. If a button is held active, the fill/exhaust will time out after 10 seconds.
 - Fill springs: buttons 1 - 4, Exhaust springs: buttons 5 - 8

Troubleshooting Guide

For further technical assistance please contact our customer service department by calling (800) 248-0892, Monday through Friday. For calls from outside the USA or Canada, our local number is (517) 322-2144.

PROBLEM	CAUSE	SOLUTION
<i>Compressor doesn't run</i>	There is a blown fuse or relay, bad ground, or poor electrical connections.	Replace the fuse, check the ground wire, or check the compressor connector
<i>Compressor runs all the time.</i>	The compressor relay is defective or there is a leak.	Replace the relay or locate the leak and repair.
<i>Air spring or tank leak.</i>	Fitting seal or air line is compromised.	Check to make sure air lines are seated in connectors. Inspect fittings with soapy water. Trim hose or re-seal fitting.
<i>Nothing happens when the vehicle is key-on ignition active</i>	There is a blown fuse or a poor connection.	Replace the fuses and check the electrical connections.
<i>The display does not light up.</i>	There is a blown fuse or a poor connection.	Replace the fuses and check the electrical connections.
<i>Compressors runs all the time but doesn't fill the tank.</i>	Compressor in-line check valve fitting has been overtorqued.	Loosen fitting and check again. Replace if needed.
<i>Display shows UNSUCCESSFUL.</i>	“Double Click” for Preset not completed within 2 second window.	If display is in sleep mode, click once to “Wake Up”, then “Double Click” desired preset within 2 seconds of each press.
	Calibration may need to be adjusted or system may need to be recalibrated.	Adjust ADJ value or recalibrate system to reduce number of iterations.
	Tank pressure settings changed.	Attempt recalibration.
	Vehicle load changed significantly.	
	Air springs/air lines/tank changed.	
<i>Display shows PRESSURE SENSOR FAILURE.</i>	ECU has detected a pressure sensor operating incorrectly.	Only manual mode can be used to operate suspension. Contact customer service immediately to resolve the problem.

Leak Testing and Detection

Leak detection

1. A leak can be defined as a loss of pressure of more than 5 psi over an 8 hour period. Be aware that ambient temperature change has an effect on pressure that may seem like a leak. For example: a change of 10deg Fahrenheit up or down from your baseline will have an approximate gain or loss of indicated pressure of 2 psi. If a leak is suspected after including any temperature change, then proceed to #2.
2. Spray soapy water (1/5 Dawn brand dish soap to 4/5 water) on suspect fittings and hose connections and look for any bubbling caused by air leakage.
3. Fix leaking connection (review pg. 6 for help on NPT fittings and air line connections).
4. Wipe down sprayed connections with rag to remove any residual soapy water.

NOTE

Dawn brand dish soap will not corrode the metals (aluminum, brass, steel) with which it comes into contact.

Electrical Schematic

AUTOPILOT V2 GEN 3 PRESSURE CONTROL

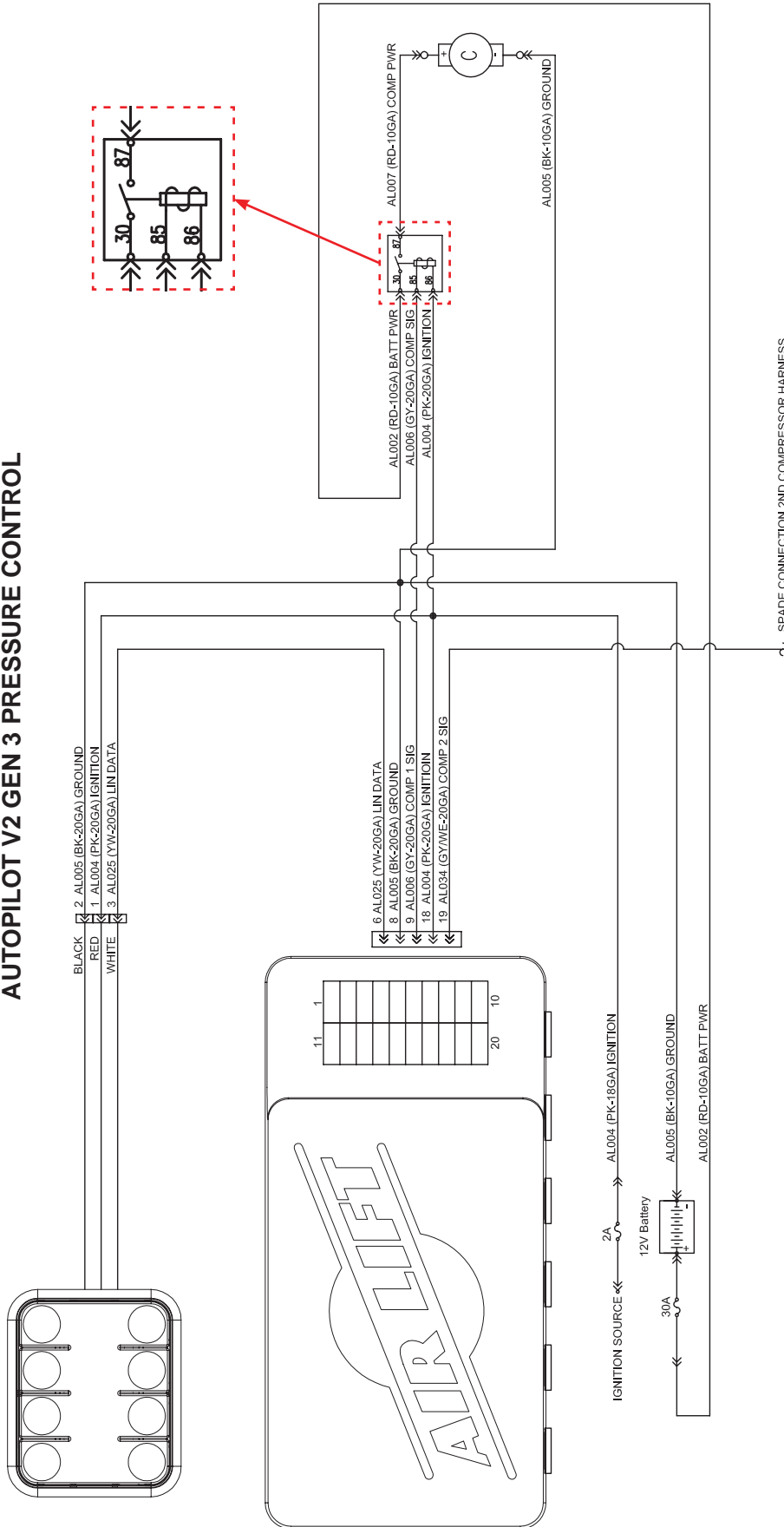

AUTOPILOT V2 SECOND COMPRESSOR HARNESS*

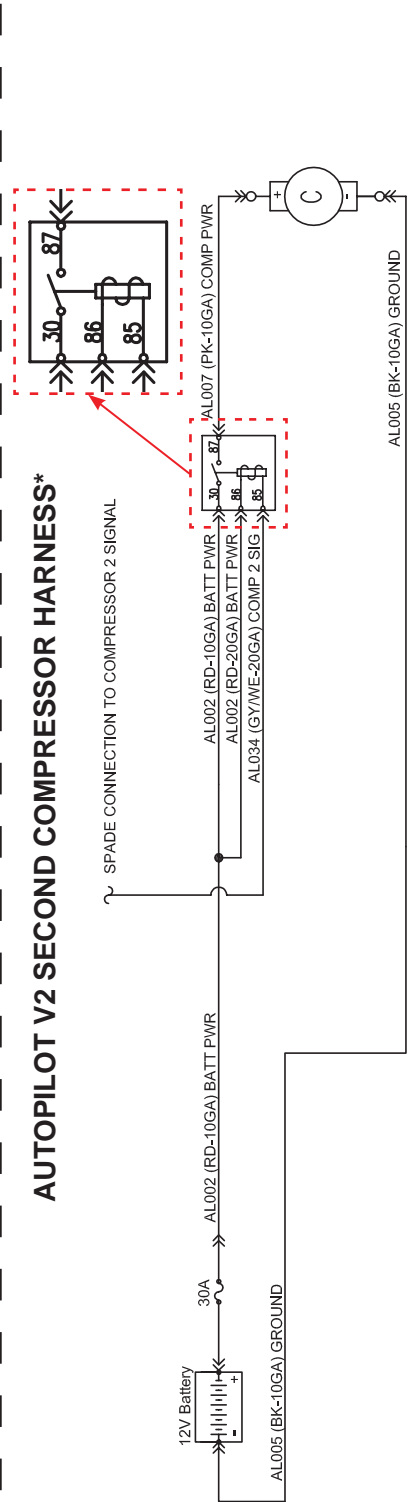

* Sold separately
Air Lift Part Number 27679

fig. 18

AutoPilot V2 Remote Control Unit Dimensions

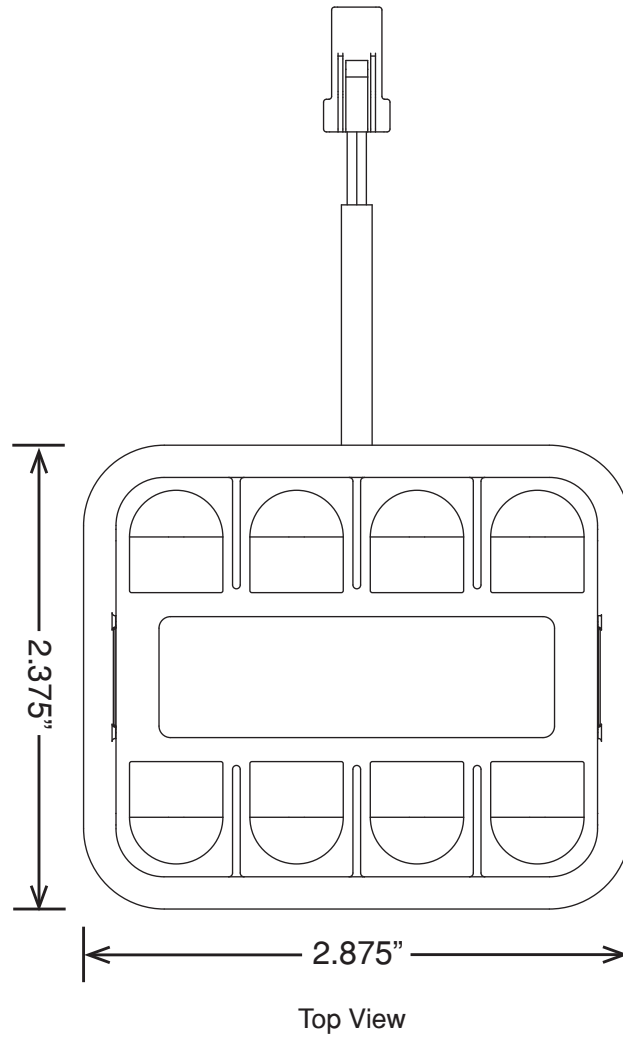

Notes

Manifold Template

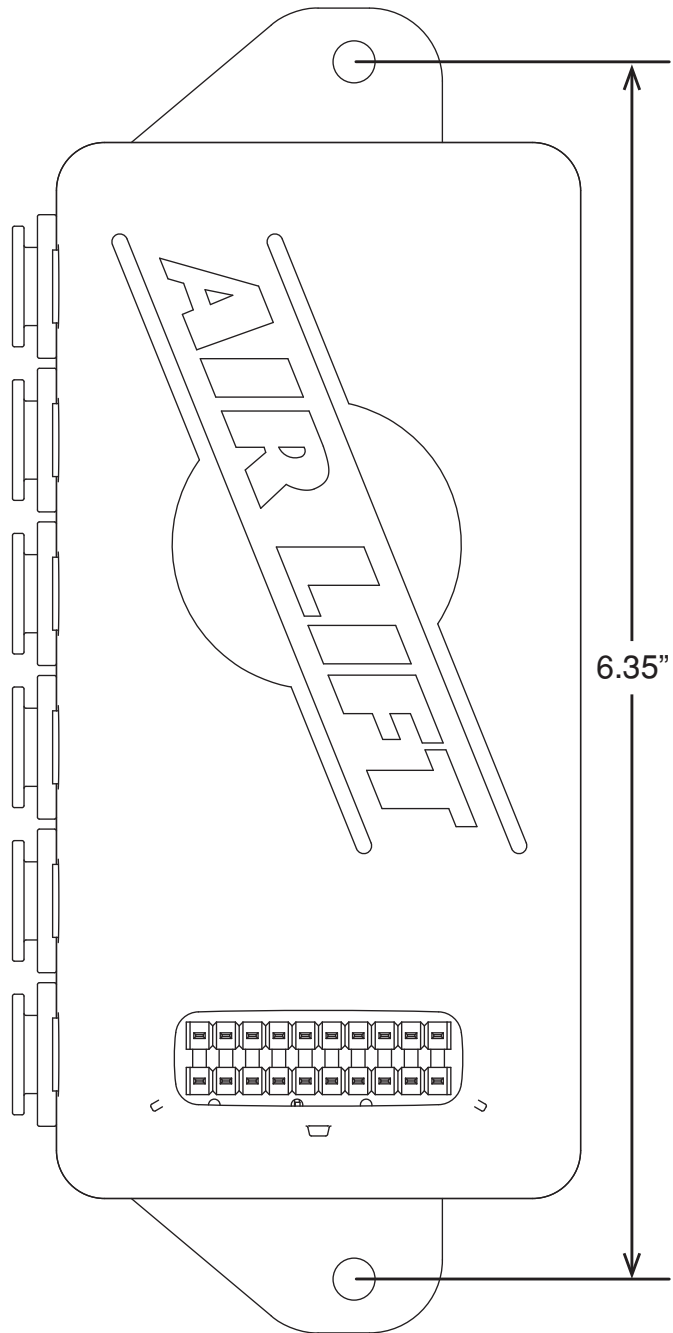

Notes

16380 Compressor Template

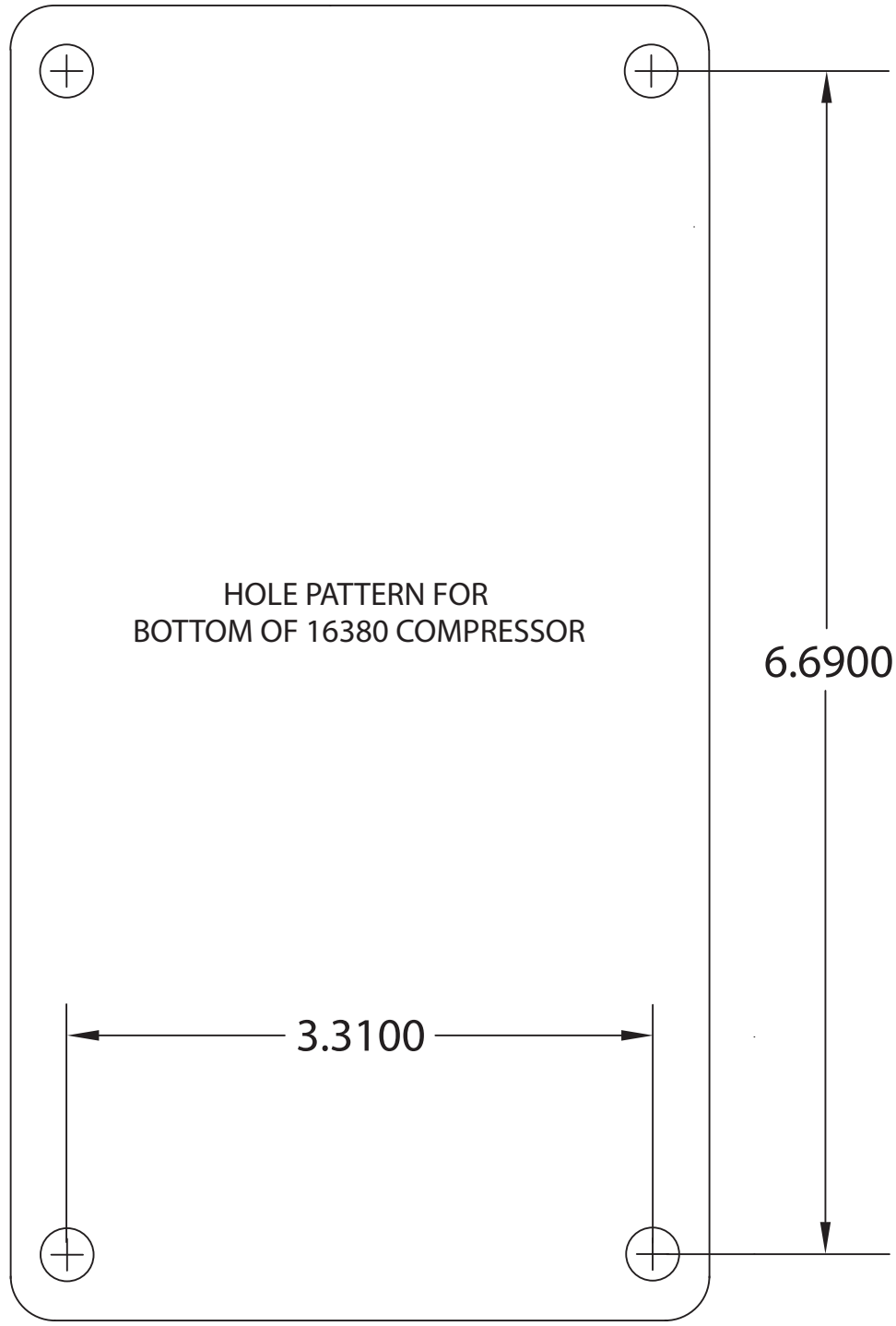

Notes

Warranty and Returns Policy

Air Lift Company warrants its performance products for one year to the original purchaser against manufacturing defects one year from the date of purchase when used on cars and trucks as specified under normal operating conditions. The warranty does not apply to products that have been improperly applied, improperly installed, or which have not been maintained in accordance with installation instructions furnished with all products. The consumer will be responsible for removing (labor charges) the defective product from the vehicle and returning it, transportation costs prepaid, to the dealer from which it was purchased or to Air Lift Company for verification.

Air Lift will repair or replace, at its option, defective products or components. A minimum \$10.00 shipping and handling charge will apply to all warranty claims. Before returning any defective product, you must call Air Lift at (800) 248-0892 in the U.S. and Canada (elsewhere, (517) 322-2144) for a Returned Materials Authorization (RMA) number. Returns to Air Lift can be sent to: Air Lift Company • 2727 Snow Road • Lansing, MI • 48917.

Product failures resulting from abnormal use or misuse are excluded from this warranty. The loss of use of the product, loss of time, inconvenience, commercial loss or consequential damages is not covered. The consumer is responsible for installation/reinstallation (labor charges) of the product. Air Lift Company reserves the right to change the design of any product without assuming any obligation to modify any product previously manufactured.

This warranty gives you specific legal rights and you may also have other rights that may vary from state-to-state. Some states do not allow limitations on how long an implied warranty lasts or allow the exclusion or limitation of incidental or consequential damages. The above limitation or exclusion may not apply to you. There are no warranties, expressed or implied including any implied warranties of merchantability and fitness, which extend beyond this warranty period. There are no warranties that extend beyond the description on the face hereof. Seller disclaims the implied warranty of merchantability. (Dated proof of purchase required.)

Replacement Information

If you need replacement parts, contact the local dealer or call Air Lift customer service at (800) 248-0892. Most parts are immediately available and can be shipped the same day.

Contact Air Lift Company customer service at (800) 248-0892 first if:

- Parts are missing from the kit.
- Need technical assistance on installation or operation.
- Broken or defective parts in the kit.
- Wrong parts in the kit.
- Have a warranty claim or question.

Contact the retailer where the kit was purchased:

- If it is necessary to return or exchange the kit for any reason.
- If there is a problem with shipping if shipped from the retailer.
- If there is a problem with the price.

Contact Information

If you have any questions, comments or need technical assistance contact our customer service department by calling (800) 248-0892, Monday through Friday. For calls from outside the USA or Canada, our local number is (517) 322-2144. You may also contact customer service anytime by e-mail at techsupport@airliftperformance.com.

For inquiries by mail, our address is PO Box 80167, Lansing, MI 48908-0167. Our shipping address for returns is 2727 Snow Road, Lansing, MI 48917.

You may also contact our sales team anytime by e-mail at sales@airliftperformance.com or on the web at www.airliftperformance.com.

Need Help?

Contact our customer service department by calling (800) 248-0892, Monday through Friday. For calls from outside the USA or Canada, our local number is (517) 322-2144.



Thank you for purchasing Air Lift Performance products!

Air Lift Company • 2727 Snow Road • Lansing, MI 48917 or PO Box 80167 • Lansing, MI 48908-0167
Toll Free (800) 248-0892 • Local (517) 322-2144 • Fax (517) 322-0240 • www.airliftperformance.com

Printed in
the USA