

Air Lift™

PERFORMANCE

Kit 78510

BMW E8X/E9X
Except AWD
and M Series

Front Application



INSTALLATION GUIDE

For maximum effectiveness and safety, please read these instructions completely before proceeding with installation.

Failure to read these instructions can result in an incorrect installation.

TABLE OF CONTENTS

Introduction	2
Notation Explanation	2
Important Safety Notices	2
Installation Diagram	3
Hardware List	3
Installing the Air Suspension	4
Preparing the Vehicle	4
Removing the Front Strut	5
Preparing the Air Suspension	8
Installing the Air Suspension	8
Damping Adjustment	11
Aligning the Vehicle	11
Adjusting Extended or Drop Height Using Lower Mount	12
Before Operating	14
Installation Checklist	14
Product Use, Maintenance and Servicing	15
Suggested Driving and Maximum Air Pressures	15
Maintaining and Operating	15
Troubleshooting Guide	15
Frequently Asked Questions	15
Tuning the Air Pressure	16
Checking for Leaks	16
Fixing Leaks	16
Warranty & Return Policy	17
Replacement Information	17
Contact Information	17

Introduction

The purpose of this publication is to assist with the installation, maintenance and troubleshooting of this BMW E8X/E9X Performance kit.

It is important to read and understand the entire installation guide before beginning installation or performing any maintenance, service or repair. The information includes a hardware list, step-by-step installation information, maintenance tips, safety information and a troubleshooting guide.

Air Lift Performance reserves the right to make changes and improvements to its products and publications at any time. For the latest version of this manual, contact Air Lift Performance at (800) 248-0892 or visit our website at www.airliftperformance.com.

NOTATION EXPLANATION

Hazard notations appear in various locations in this publication. Information which is highlighted by one of these notations must be observed to help minimize risk of personal injury or possible improper installation which may render the vehicle unsafe. Notes are used to help emphasize areas of procedural importance and provide helpful suggestions. The following definitions explain the use of these notations as they appear throughout this guide.

 **DANGER**

INDICATES IMMEDIATE HAZARDS WHICH WILL RESULT IN SEVERE PERSONAL INJURY OR DEATH.

 **WARNING**

INDICATES HAZARDS OR UNSAFE PRACTICES WHICH COULD RESULT IN SEVERE PERSONAL INJURY OR DEATH.

 **CAUTION**

INDICATES HAZARDS OR UNSAFE PRACTICES WHICH COULD RESULT IN DAMAGE TO THE MACHINE OR MINOR PERSONAL INJURY.

NOTE

Indicates a procedure, practice or hint which is important to highlight.

IMPORTANT SAFETY NOTICES

The installation of this kit does not alter the Gross Vehicle Weight Rating (GVWR) or payload of the vehicle. Check your vehicle's owner's manual and do not exceed the maximum load listed for your vehicle.

Gross Vehicle Weight Rating: The maximum allowable weight of the fully loaded vehicle (including passengers and cargo). This number — along with other weight limits, as well as tire, rim size and inflation pressure data — is shown on the vehicle's Safety Compliance Certification Label.

Payload: The combined, maximum allowable weight of cargo and passengers that the vehicle is designed to carry. Payload is GVWR minus the Base Curb Weight.

 **WARNING**

DO NOT INFLATE AIR SPRINGS WHILE OFF OF THE VEHICLE. DAMAGE TO ASSEMBLY MAY RESULT AND VOID WARRANTY.

 **CAUTION**

DO NOT WELD TO, OR MODIFY PERFORMANCE STRUTS/SOCKS IN ANY WAY. DAMAGE TO UNIT MAY OCCUR AND WILL VOID WARRANTY.

Installation Diagram

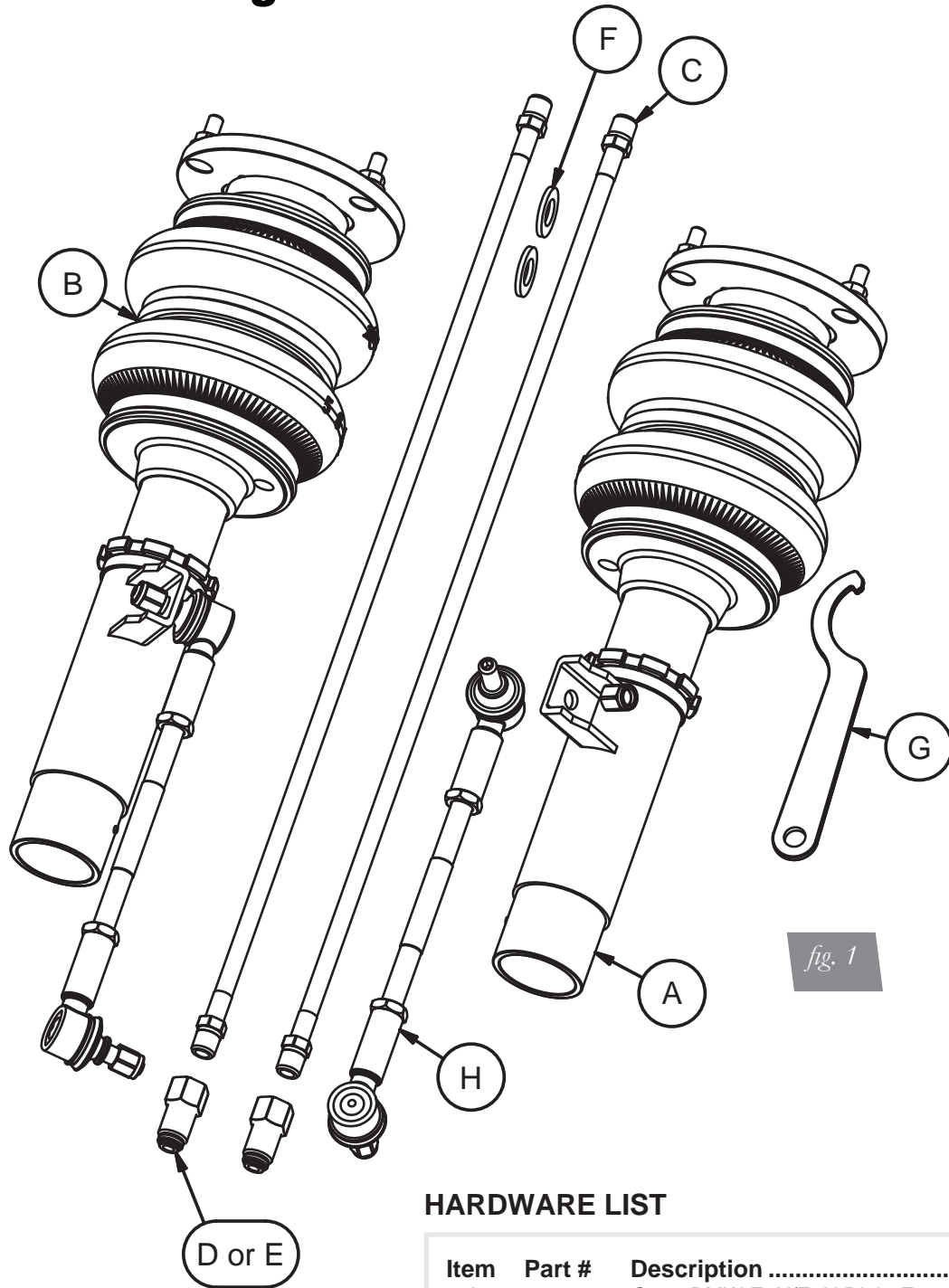

HARDWARE LIST

Item	Part #	Description	Qty
A	35286	Strut, BMW E8X/E9X Right Front.....	1
B	35287	Strut, BMW E8X/E9X Left Front	1
C	20997	Leader Hose, 1/4" ID	2
D	21810	Union, 1/4"FNPT X 1/4" PTC, DOT	2
E	21987	Union, 1/4"FNPT X 3/8" PTC, DOT	2
F	18571	M14 Flat Washer	2
G		Spanner Wrench.....	1
H		End Link 260mm.....	2



Missing or damaged parts? Call Air Lift customer service at (800) 248-0892 for a replacement part.

Installing the Air Suspension

PREPARING THE VEHICLE

1. Elevate and support the vehicle with a hoist or jack stands.
2. Remove the front tire and support the hub assembly (fig. 2).

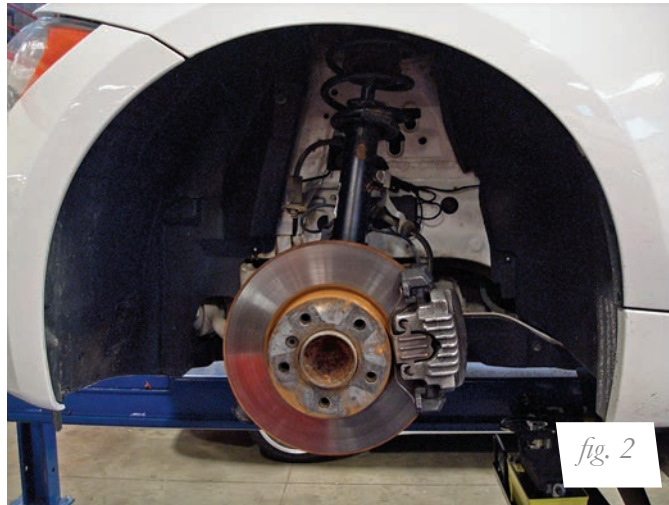

fig. 2

3. Disconnect the headlight alignment bracket from the lower control arm (if equipped) (figs. 3 and 4).



fig. 3

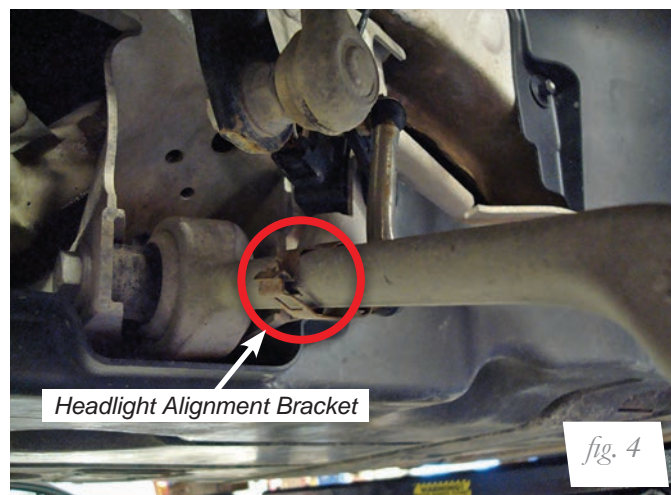
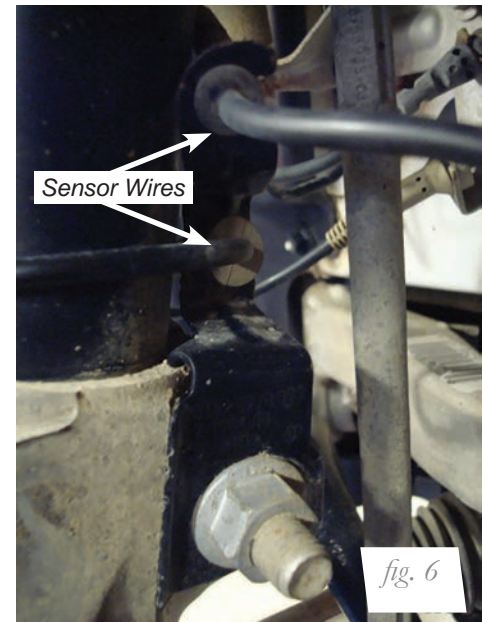
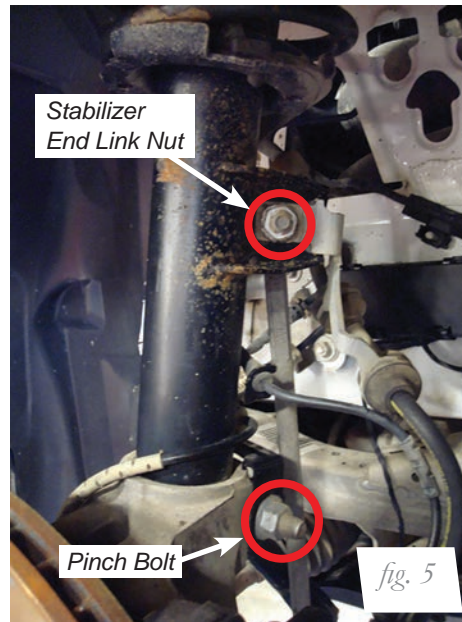

fig. 4

REMOVING THE FRONT STRUT

1. Disconnect the stabilizer end link nut and pinch bolt from the strut assembly (fig. 5). This will allow the removal of the brake line and ABS sensor wire brackets from the strut (fig. 6).



2. Remove the stabilizer end link from the bar (fig. 7).



3. Loosen the rearward control arm bushing to the sub frame (fig. 8).



4. Unbolt the forward control arm and tie rod from the hub (figs. 9 and 10).



5. Slide the hub off of the strut (fig. 11), taking care not to over-extend the brake line or ABS wires.



6. Remove the three upper mount bracket nuts (fig. 12) and remove the strut from the vehicle (fig. 13).



7. Reattach the tie rod and forward control arm to the hub assembly (fig. 14). Support the hub to prevent over extension of the ball joints, hoses or sensor wires (fig. 15).



PREPARING THE AIR SUSPENSION

1. Begin by installing the leader line into the air spring (fig. 16). Wrap the threads of the leader hose with thread sealant. Tighten the appropriate fitting to the leader line 1-3/4 turns beyond hand tight. Tighten the leader line into the air spring 1-3/4 turns beyond hand tight.

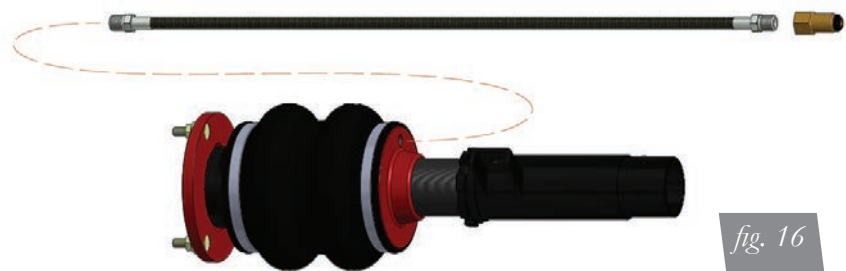

INSTALLING THE AIR SUSPENSION

1. Insert the strut into the strut tower and attach the camber plate bolts to the chassis (fig. 17).



2. The factory strut tower brace needs a thin spacer (F) placed underneath the outboard attaching point. This will allow the use of the damping adjustment knob. Unbolt (fig. 18) and place the spacer under the brace (figs. 19 and 20), bolt back in (fig. 21).

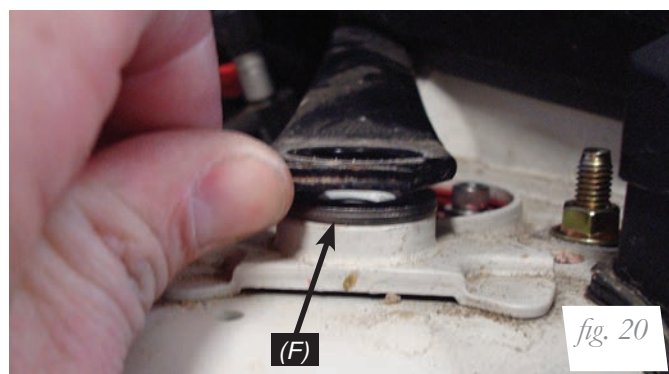

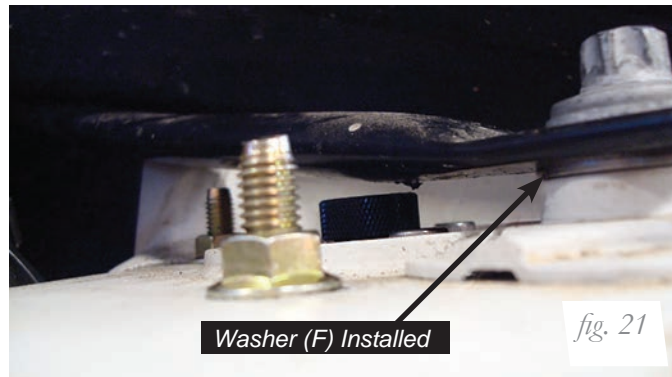

3. Lift the hub onto the strut adapter (fig. 22). Reinstall the lower pinch bolt with the sensor wire bracket in place (fig. 23).

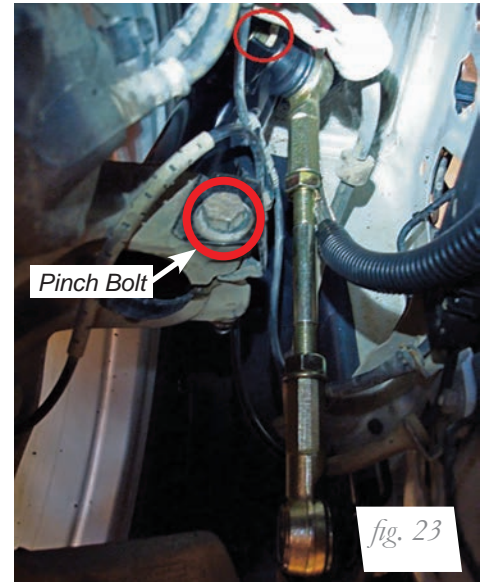

4. Assemble the stabilizer bar end link with the brake line bracket to the strut (fig. 23). Orient the upper and lower end link ball joints in a manner that allows for proper articulation of the end link without damaging the ball joint. The ball joints of the link should be squarely installed in the mounting holes when properly adjusted.

NOTE

Stabilizer end links are adjustable and need to be set at the same length (fig. 24). The recommended setting from ball joint centers is 260mm (10.24"). Accurately measuring between ball joint centers can be difficult using standard equipment. The distance between the two rod end flats is 115mm (4.53"). Make certain that an equal amount of thread is showing on both sides of the center of the rod.

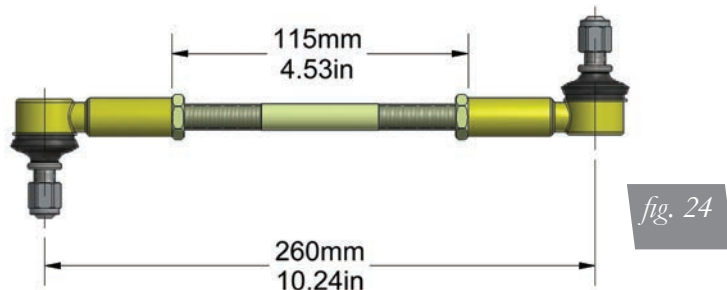

5. Attach the end link to the stabilizer bar. Torque the upper and lower ball joint nuts to 58Nm/43lb-ft.

6. Reattach the headlight alignment bracket to the lower control arm (if equipped) (fig. 25).

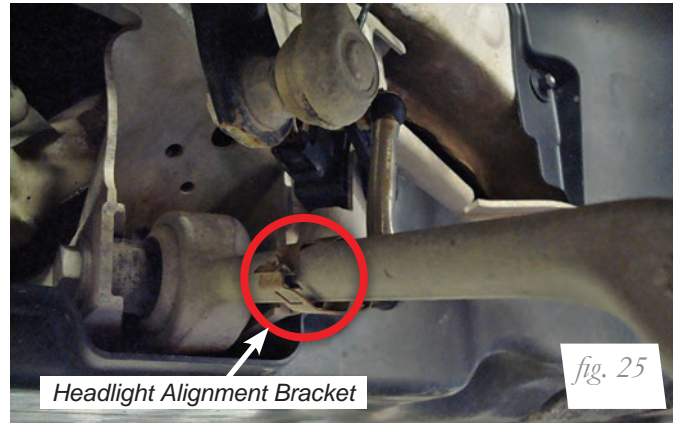

7. Fully compress the suspension using a jack. With the suspension compressed, review the best routing for the leader hose that is clear of all suspension components and axle. Routing should also allow for the suspension to extend without kinking or pulling the line tight or rubbing on other components. Following the brake line routing is often a good place to start. Check clearances to all other components.
8. With the suspension fully compressed, take a measurement from the fender to some reference point – typically the center of the axle. Record this measurement as Max Compression.
9. Cycle the suspension to Max Extension and record the measurement from the same reference points.
10. Add ME and MC then divide by 2. Set the suspension to this point. This position will give 50% stroke in either direction and is a starting point for ride height (fig. 26).

Formula for Calculating Ride Height

$$(ME+MC) \div 2 = \text{MID STROKE}$$

fig. 26

11. With the suspension at this position, loosen, then re-torque the lower control arm bolts to manufacturer's specifications (Table 1).

Torque Specifications		
Location	Nm	lb-ft
Camber plate to chassis	19	14
Strut lower pinch bolt to hub	56 + 90°	41 + 90°
End link to strut/stabilizer bar	58	43
Tie rod to hub	165	122
Forward control arm to hub	175	129
Forward control arm to sub frame	68	50
Wheel studs	120	89

Table 1

DAMPING ADJUSTMENT

The struts in this kit have 30 settings, or “clicks”, of adjustable compression and rebound damping characteristics. Damping is changed through the strut rod using the supplied adjuster (figs. 27 & 28) or a 3mm allen wrench.

Turn the adjuster clockwise and the damping settings are hardened. Turn the adjuster counterclockwise and the damping is softened.

Each shock is preset to “-20 clicks”. This means that the shock is adjusted 20 clicks away from full stiff. Counting down from full stiff is the preferred method of keeping track of, or setting, damping. This setting was developed on a 2008 BMW 135i and may need to be adjusted to different vehicles and driving characteristics.



fig. 27

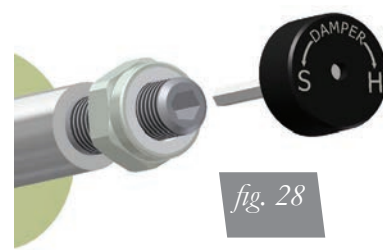

fig. 28

ALIGNING THE VEHICLE

1. Using the control system, set the vehicle height to the new custom ride height.
2. If the custom ride height is lower than stock, we recommend loosening all pivot points (bolts, nuts) on any control arm, strut arm or radius rod that contains bushings. Once they have been loosened, re-torque to stock specifications.

NOTE

It may be necessary to cycle the suspension to loosen the bushing up from its mount. This will help re-orient the bushing at its new position based on the custom ride height.

ADJUSTING EXTENDED OR DROP HEIGHT USING LOWER MOUNT

Your struts have been pre-set at the factory to provide maximum drop height while maintaining adequate tire clearance to the air spring. If you wish to gain more extended height (lift), which is the same as reducing drop height, or want to lower the chassis further, have made other chassis modifications to allow further drop, and there is still adjustment available at the lower mount, please use the following procedure:

1. Support the vehicle with jack stands or a hoist at approved lifting points.
2. Remove the wheel.
3. Using the supplied spanner wrench, loosen the lower locking collar (fig. 29).

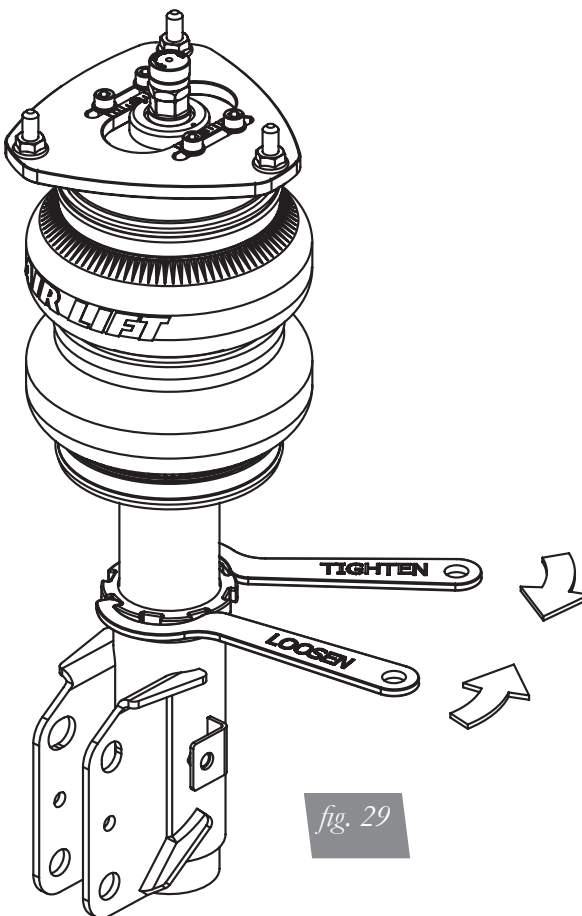

4. Deflate the air spring to 0 PSI on the corner you are adjusting.
5. Disconnect lower mount from suspension.
6. Spin the lower mount to the desired location.

NOTE

Not all models will have further drop height available.

7. Re-install lower mount to suspension and torque fasteners.
8. Tighten the lower locking collar to the lower mount using significant force.

CAUTION

WHEN ADJUSTING HEIGHT UPWARDS, MAKE SURE THAT THE STRUT BODY ENGAGES ALL THE THREADS OF THE LOWER MOUNT (FIG. 30). WHEN ADJUSTING DOWNWARDS, MAKE SURE THERE IS ADEQUATE AIR SPRING CLEARANCE TO THE TIRE/WHEEL ASSEMBLY. CLEARANCE MUST BE CHECKED WITH SYSTEM FULLY DEFLATED AS WELL AS FULLY INFLATED TO ENSURE THAT NO RUBBING OCCURS. FAILURE TO MAINTAIN ADEQUATE CLEARANCE CAN RESULT IN AIR SPRING FAILURE AND WILL NOT BE COVERED UNDER WARRANTY.

CAUTION

DO NOT ADJUST HEIGHT BY SPINNING AIR SPRING ON STRUT! DOING SO MAY CAUSE AN AIR LEAK AND COMPROMISE THE ASSEMBLY.

FOR STRUTS:

FOR SHOCKS:

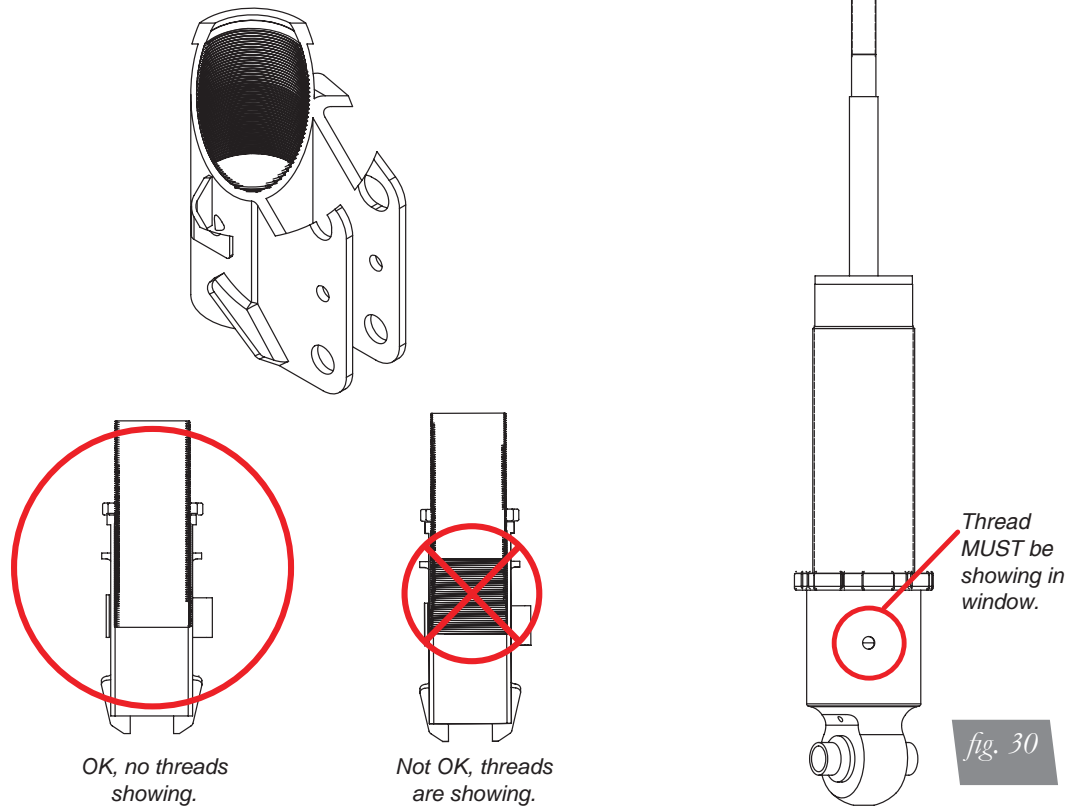

Before Operating

CAUTION

MAKE SURE THE FRONT WHEELS ARE STRAIGHT WHEN DEFLATING AND REINFLATING AIR BAGS.

1. Inflate and deflate the system (do not exceed 125 PSI) to check for clearance or binding issues. With the air springs deflated, check clearances on everything so as not to pinch brake lines, vent tubes, etc. Clear lines if necessary.
2. Inflate the air springs to 75-90 PSI and check all connections for leaks.
3. Air Lift part #27669 or #27671, AutoPilot V2 Air Management System, is highly recommended for this product.
4. Please familiarize yourself further with this product by reading the Product Use, Maintenance and Servicing section.

INSTALLATION CHECKLIST

- Clearance test — Inflate the air springs to 75-90 PSI and make sure there is at least ½” clearance from anything that might rub against each sleeve. Be sure to check the tire, brake drum, frame, shock absorbers and brake cables.
- Leak test before road test — Inflate the air springs to 75-90 PSI and check all connections for leaks. All leaks must be eliminated before the vehicle is road tested.
- Heat test — Be sure there is sufficient clearance from heat sources, at least 6” for air springs and air lines. If a heat shield was included in the kit, install it. If there is no heat shield, but one is required, call Air Lift customer service at (800) 248-0892.
- Fastener test — Recheck all bolts for proper torque.
- Road test — The vehicle should be road tested after the preceding tests. Inflate the springs to recommended driving pressures. Drive the vehicle 10 miles and recheck for clearance, loose fasteners and air leaks.
- Operating instructions — If professionally installed, the installer should review the operating instructions with the owner. Be sure to provide the owner with all of the paperwork that came with the kit.

Technician's Signature _____

Date _____

POST-INSTALLATION CHECKLIST

- Overnight leak down test — Recheck air pressure after the vehicle has been used for 24 hours. If the pressure has dropped more than 5 PSI, then there is a leak that must be fixed. Either fix the leak yourself or return to the installer for service.
- Air pressure requirements — Regardless of load, the air pressure should always be adjusted to maintain adequate ride height at all times while driving.
- Thirty day or 500 mile test — Recheck the air spring system after 30 days or 500 miles, whichever comes first. If any part shows signs of rubbing or abrasion, the source should be identified and moved, if possible. If it is not possible to relocate the cause of the abrasion, the air spring may need to be remounted. If professionally installed, the installer should be consulted. Check all fasteners for tightness.

Product Use, Maintenance and Servicing

Suggested Driving Air Pressure	Maximum Air Pressure
45 PSI	125 PSI
FAILURE TO MAINTAIN ADEQUATE MINIMUM PRESSURE (OR PRESSURE PROPORTIONAL TO LOAD) WILL RESULT IN BOTTOMING OUT, OVER-EXTENSION OR RUBBING AGAINST ANOTHER COMPONENT AND WILL VOID THE WARRANTY.	

MAINTENANCE GUIDELINES

NOTE

By following these steps, vehicle owners will obtain the longest life and best results from their air spring.

1. Check the air pressure before driving.
2. Never inflate beyond 125 PSI.
3. If you develop an air leak in the system, use a soapy water solution to check all air line connections, before deflating and removing the spring.
4. When increasing load, always adjust the air pressure to maintain normal ride height. Increase or decrease pressure from the system as necessary to attain normal ride height for optimal ride and handling. Remember that loads carried behind the axle (including tongue loads) require more leveling force (pressure) than those carried directly over the axle.



CAUTION

FOR YOUR SAFETY AND TO PREVENT DAMAGE TO YOUR VEHICLE, DO NOT EXCEED MAXIMUM GROSS VEHICLE WEIGHT RATING (GVWR), AS INDICATED BY THE VEHICLE MANUFACTURER. ALTHOUGH YOUR AIR SPRINGS ARE RATED AT A MAXIMUM INFLATION PRESSURE OF 125 PSI, THE AIR PRESSURE ACTUALLY NEEDED IS DEPENDENT ON YOUR LOAD.

5. Always add air to the springs in small quantities, checking the pressure frequently. Sleeves require less air volume than a tire and inflate quickly.
6. Should it become necessary to raise the vehicle by the frame, make sure the control system is turned off before lifting.

Troubleshooting Guide

1. Leak test the air line connections, the threaded connection into the air spring, and all fittings in the control system.
2. Inspect the air lines to be sure none are pinched. Tie straps may be too tight. Loosen or replace the strap and replace leaking components.
3. Inspect the air line for holes and cracks. Replace as needed.
4. Look for a kink or fold in the air line. Reroute as needed.

If the preceding steps do not solve the problem, it is possibly caused by a failed air spring — either a factory defect or an operating problem. Please call Air Lift at (800) 248-0892 for assistance.

Frequently Asked Questions

Q. Will installing air springs increase the weight ratings of a vehicle?

No. Adding air springs will not change the weight ratings (GAWR, GCWR and/or GVWR) of a vehicle. Exceeding the GVWR is dangerous and voids the Air Lift warranty.

Q. How long should air springs last?

If the air springs are properly installed and maintained they can last indefinitely.

Q. Will raising the vehicle on a hoist for service work damage the air springs?

No. The vehicle can be lifted on a hoist for short-term service work such as tire rotation or oil changes. However, if the vehicle will be on the hoist for a prolonged period of time, support the axle with jack stands in order to take the tension off of the air springs.

Tuning the Air Pressure

Pressure determination comes down to three things — level vehicle, ride comfort, and stability.

1. Level vehicle

If the vehicle's headlights are shining into the trees or the vehicle is leaning to one side, then it is not level. Raise the air pressure to correct either of these problems and level the vehicle.

2. Ride comfort

If the vehicle has a rough or harsh ride it may be due to either too much pressure or not enough. Try different pressures to determine the best ride comfort. See Air Lift suggested driving air pressure.

3. Stability

Stability translates into safety and should be the priority, meaning the driver may need to sacrifice a perfectly level and comfortable ride. Stability issues include roll control, bounce, dive during braking and sponginess. Tuning out these problems usually requires additional air pressure, strut damping, or both.

Checking for leaks

1. Inflate the air spring to 80 PSI.
2. Spray all connections and the inflation valves with a solution of 1/5 liquid dish soap and 4/5 water. Spot leaks easily by looking for bubbles in the soapy water.
3. After the test, deflate the springs to the minimum pressure required to restore the system to normal ride height.
4. Check the air pressure again after 24 hours. A 2-4 PSI loss after initial installation is normal. Retest for leaks if the loss is more than 5 PSI.

Fixing Leaks

1. If there is a problem with a swivel fitting:
 - a. Check the air line connection by deflating the spring and removing the line by pulling the collar against the fitting and pulling firmly on the air line. Trim 1" off the end of the air line. Be sure the cut is clean and square (see fig. 31). Reinsert the air line into the push-to-connect fitting.
 - b. Check the threaded connection by tightening the swivel fitting another 1/2 turn. If it still leaks, deflate the air spring, remove the fitting, and re-coat the threads with thread sealant. Reinstall by hand tightening as much as possible and then use a wrench for an additional two turns.
2. If the preceding steps have not resolved the problem, call Air Lift customer service at (800) 248-0892.

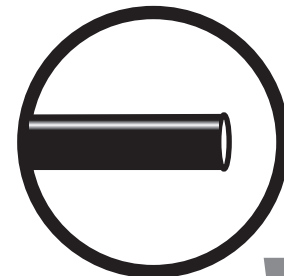
*fig. 31*

Warranty and Returns Policy

Air Lift Performance warrants its performance products for one year to the original purchaser against manufacturing defects one year from the date of purchase when used on cars and trucks as specified under normal operating conditions. The warranty does not apply to products that have been improperly applied, improperly installed, or which have not been maintained in accordance with installation instructions furnished with all products. The consumer will be responsible for removing (labor charges) the defective product from the vehicle and returning it, transportation costs prepaid, to the dealer from which it was purchased or to Air Lift Performance for verification.

Air Lift will repair or replace, at its option, defective products or components. A minimum \$10.00 shipping and handling charge will apply to all warranty claims. Before returning any defective product, you must call Air Lift at (800) 248-0892 in the U.S. and Canada (elsewhere, (517) 322-2144) for a Returned Materials Authorization (RMA) number. Returns to Air Lift can be sent to: Air Lift Performance • 2727 Snow Road • Lansing, MI • 48917.

Product failures resulting from abnormal use or misuse are excluded from this warranty. The loss of use of the product, loss of time, inconvenience, commercial loss or consequential damages is not covered. The consumer is responsible for installation/reinstallation (labor charges) of the product. Air Lift Performance reserves the right to change the design of any product without assuming any obligation to modify any product previously manufactured.

This warranty gives you specific legal rights and you may also have other rights that may vary from state-to-state. Some states do not allow limitations on how long an implied warranty lasts or allow the exclusion or limitation of incidental or consequential damages. The above limitation or exclusion may not apply to you. There are no warranties, expressed or implied including any implied warranties of merchantability and fitness, which extend beyond this warranty period. There are no warranties that extend beyond the description on the face hereof. Seller disclaims the implied warranty of merchantability. (Dated proof of purchase required.)

Replacement Information

If you need replacement parts, contact the local dealer or call Air Lift customer service at (800) 248-0892. Most parts are immediately available and can be shipped the same day.

Contact Air Lift Performance customer service at (800) 248-0892 first if:

- Parts are missing from the kit.
- Need technical assistance on installation or operation.
- Broken or defective parts in the kit.
- Wrong parts in the kit.
- Have a warranty claim or question.

Contact the retailer where the kit was purchased:

- If it is necessary to return or exchange the kit for any reason.
- If there is a problem with shipping if shipped from the retailer.
- If there is a problem with the price.

Contact Information

If you have any questions, comments or need technical assistance contact our customer service department by calling (800) 248-0892, Monday through Friday. For calls from outside the USA or Canada, our local number is (517) 322-2144. You may also contact customer service anytime by e-mail at techsupport@airliftperformance.com.

For inquiries by mail, our address is PO Box 80167, Lansing, MI 48908-0167. Our shipping address for returns is 2727 Snow Road, Lansing, MI 48917.

You may also contact our sales team anytime by e-mail at sales@airliftperformance.com or on the web at www.airliftperformance.com.

Need Help?

Contact our customer service department by calling (800) 248-0892, Monday through Friday. For calls from outside the USA or Canada, our local number is (517) 322-2144.



Thank you for purchasing Air Lift Performance products!

Air Lift Performance • 2727 Snow Road • Lansing, MI 48917 or PO Box 80167 • Lansing, MI 48908-0167
Toll Free (800) 248-0892 • Local (517) 322-2144 • Fax (517) 322-0240 • www.airliftperformance.com

Printed in
the USA

Air Lift™ **PERFORMANCE**

Kits 78610 & 78609

BMW E8X/E9X
Non M series

Rear Application



AIR LIFT
PERFORMANCE™

INSTALLATION GUIDE

IMPORTANT: WHEN PURCHASING KIT 78609 WITHOUT REAR SHOCKS, YOU MUST ACQUIRE BMW E9X M3 SHOCKS. E8X/E9X REAR SHOCKS WILL NOT WORK WITH THIS KIT.

For maximum effectiveness and safety, please read these instructions completely before proceeding with installation.

Failure to read these instructions can result in an incorrect installation.

TABLE OF CONTENTS

Introduction	2
Notation Explanation	2
Important Safety Notices	2
Installation Diagram	3
Hardware List	3
Installing the Air Suspension	4
Preparing the Vehicle	4
Removing the Rear Suspension	5
Assembling the Air Spring Upper Bracket and Air Fitting	7
Installing the Air Suspension	8
Installing Shocks	10
Damping Adjustment	12
Aligning the Vehicle	12
Adjusting Extended or Drop Height Using Lower Mount	13
Before Operating	15
Installation Checklist	15
Product Use, Maintenance and Servicing	16
Suggested Driving and Maximum Air Pressures	16
Maintaining and Operating	16
Troubleshooting Guide	16
Frequently Asked Questions	16
Tuning the Air Pressure	17
Checking for Leaks	17
Fixing Leaks	17
Warranty & Return Policy	18
Replacement Information	18
Contact Information	18

Introduction

The purpose of this publication is to assist with the installation, maintenance and troubleshooting of this BMW E8X/E9X Performance kit.

It is important to read and understand the entire installation guide before beginning installation or performing any maintenance, service or repair. The information includes a hardware list, step-by-step installation information, maintenance tips, safety information and a troubleshooting guide.

Air Lift Performance reserves the right to make changes and improvements to its products and publications at any time. For the latest version of this manual, contact Air Lift Performance at (800) 248-0892 or visit our website at www.airliftperformance.com.

NOTATION EXPLANATION

Hazard notations appear in various locations in this publication. Information which is highlighted by one of these notations must be observed to help minimize risk of personal injury or possible improper installation which may render the vehicle unsafe. Notes are used to help emphasize areas of procedural importance and provide helpful suggestions. The following definitions explain the use of these notations as they appear throughout this guide.

 **DANGER**

INDICATES IMMEDIATE HAZARDS WHICH WILL RESULT IN SEVERE PERSONAL INJURY OR DEATH.

 **WARNING**

INDICATES HAZARDS OR UNSAFE PRACTICES WHICH COULD RESULT IN SEVERE PERSONAL INJURY OR DEATH.

 **CAUTION**

INDICATES HAZARDS OR UNSAFE PRACTICES WHICH COULD RESULT IN DAMAGE TO THE MACHINE OR MINOR PERSONAL INJURY.

NOTE

Indicates a procedure, practice or hint which is important to highlight.

IMPORTANT SAFETY NOTICES

The installation of this kit does not alter the Gross Vehicle Weight Rating (GVWR) or payload of the vehicle. Check your vehicle's owner's manual and do not exceed the maximum load listed for your vehicle.

Gross Vehicle Weight Rating: The maximum allowable weight of the fully loaded vehicle (including passengers and cargo). This number — along with other weight limits, as well as tire, rim size and inflation pressure data — is shown on the vehicle's Safety Compliance Certification Label.

Payload: The combined, maximum allowable weight of cargo and passengers that the vehicle is designed to carry. Payload is GVWR minus the Base Curb Weight.

 **WARNING**

DO NOT INFLATE AIR SPRINGS WHILE OFF OF THE VEHICLE. DAMAGE TO ASSEMBLY MAY RESULT AND VOID WARRANTY.

 **CAUTION**

DO NOT WELD TO, OR MODIFY PERFORMANCE STRUTS/SHOCKS IN ANY WAY. DAMAGE TO UNIT MAY OCCUR AND WILL VOID WARRANTY.

Installation Diagram

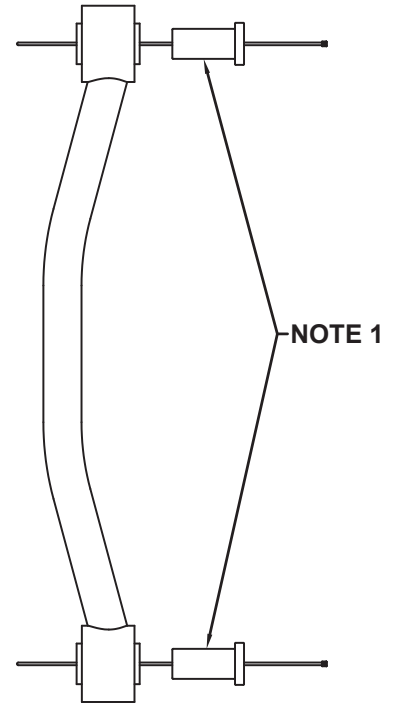
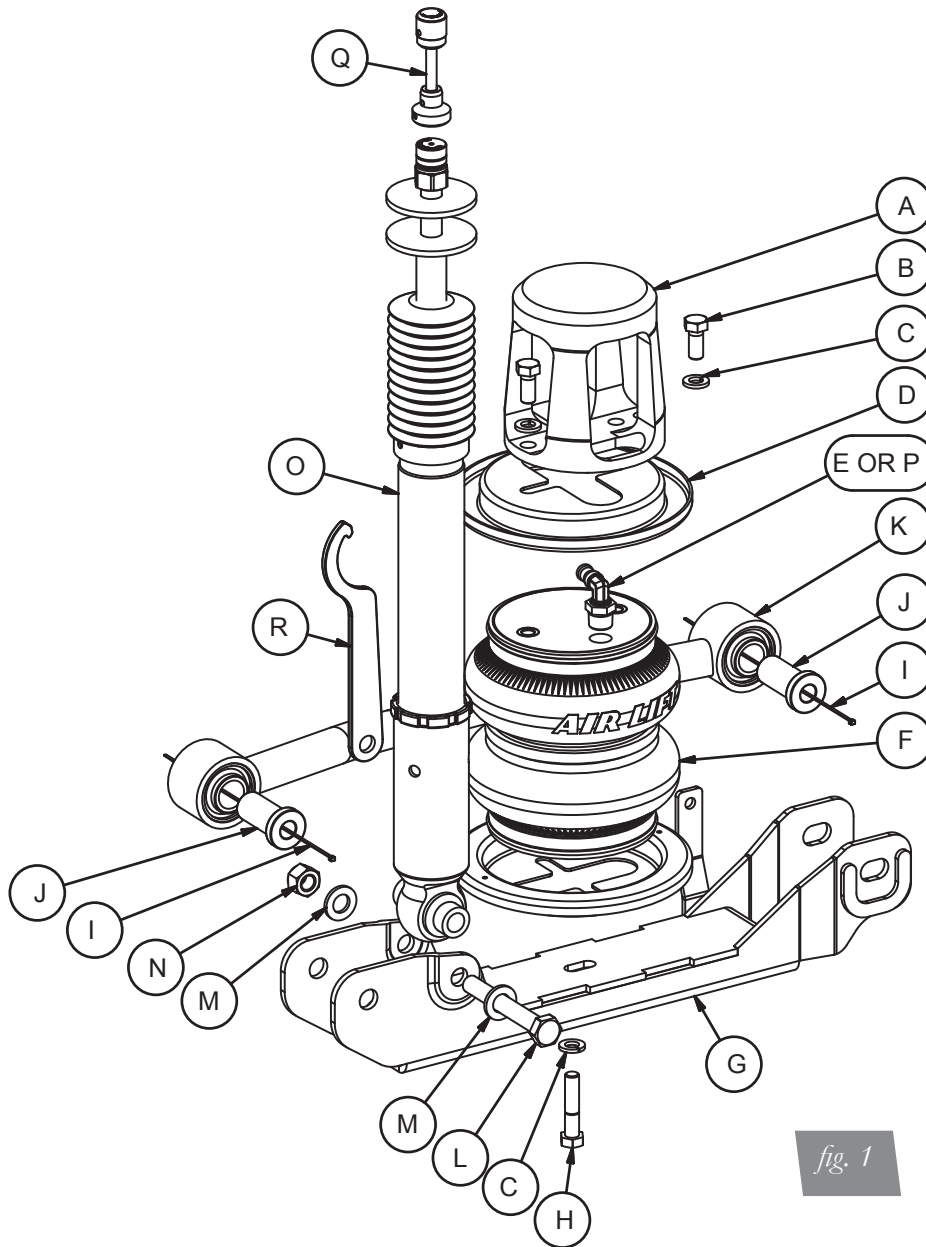

NOTE:

- 1) Remove the zip ties that hold the bushing spacers into the toe link before installation. The shoulder of the spacer is to be opposite the bend for air spring clearance purposes.
- 2) Shock, adjuster extension and wrench may not be included depending on the kit purchased.

fig. 1

HARDWARE LIST

Item	Part #	Description	Qty	Item	Part #	Description	Qty
A	13314	Rear Upper Bracket	2	J	13988	Bushing, 20mm	4
B	17203	3/8"-24 X 7/8" Hex Bolt	4	K	11127	Toe Link	2
C	18427	3/8" Lock Washer	6	L	17488	M12-1.75 X 90 Hex Cap Screw	2
D	11801	Roll Plate	4	M	18547	Flat Washer	4
E	21846	3/8"MNPT X 1/4"PTC, 90°	2	N	18546	Nyloc Nut	2
F	58530	Air Spring	2	O	26749	Rear Shock, BMW E8X/E9X	2
G	11126	Control Arm, Rear	2	P	21867	3/8"MNPT X 3/8"PTC	1
H	17484	3/8-24 X 1.75" Hex Cap Screw	2	Q		Flex Adjuster Extension	2
I	10466	8" Zip Tie	4	R		Spanner Wrench	1



Missing or damaged parts? Call Air Lift customer service at (800) 248-0892 for a replacement part.

Installing the Air Suspension

PREPARING THE VEHICLE

1. Elevate and support the vehicle with a hoist or jack stands.
2. Remove the rear tire and support the hub assembly (fig. 2).

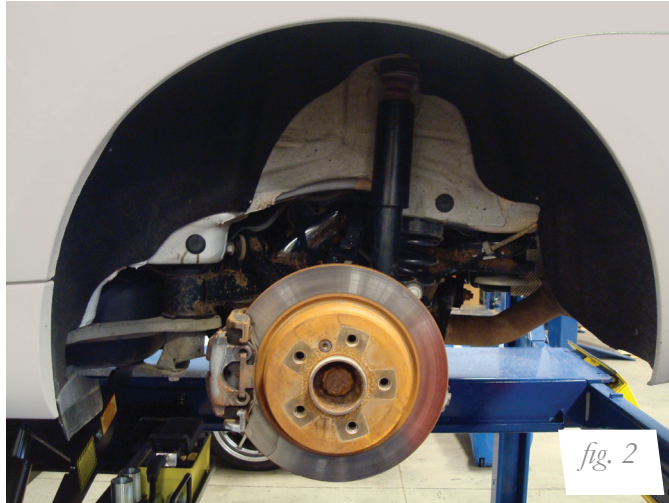

3. Disconnect the headlight alignment linkage from the lower control arm bracket (if equipped) (fig. 3).



REMOVING THE REAR SUSPENSION

1. Remove the coil spring and rubber spring isolator from the top spring seat (fig. 4).
COIL SPRING UNDER COMPRESSION. COIL SPRINGS SHOULD BE REMOVED USING FACTORY PRESCRIBED GUIDELINES.

 **CAUTION**

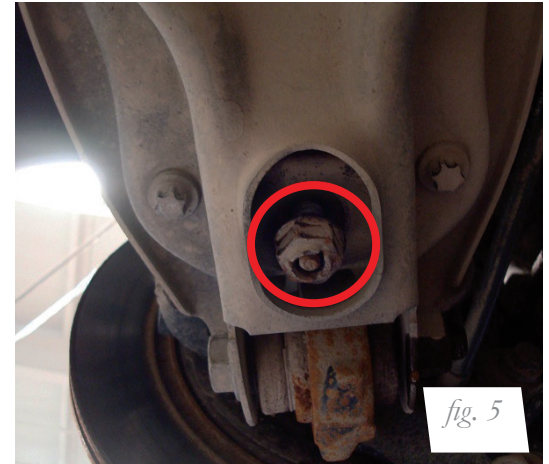
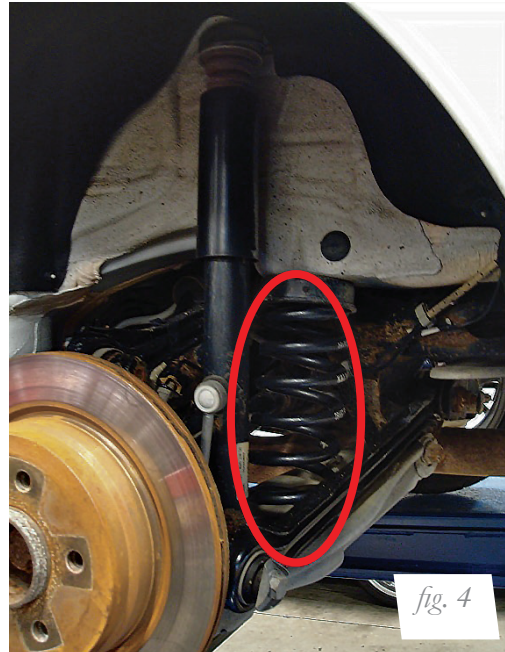

2. Disconnect the lower shock nut from the isolated mount (fig. 5).
3. Support the lower control arm and unbolt the lower control arm from the hub assembly and sub-frame (fig. 6). Remove the lower control arm.

NOTE

Some factory exhaust pieces may need to be removed or lowered to remove the cam bolt that attaches the lower control arm to the sub-frame.

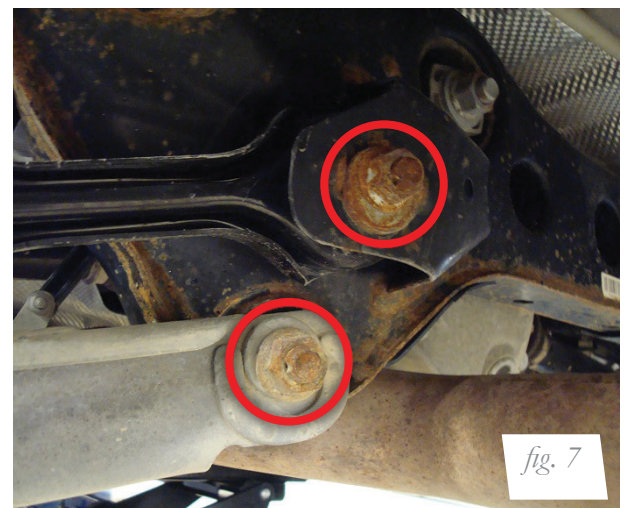
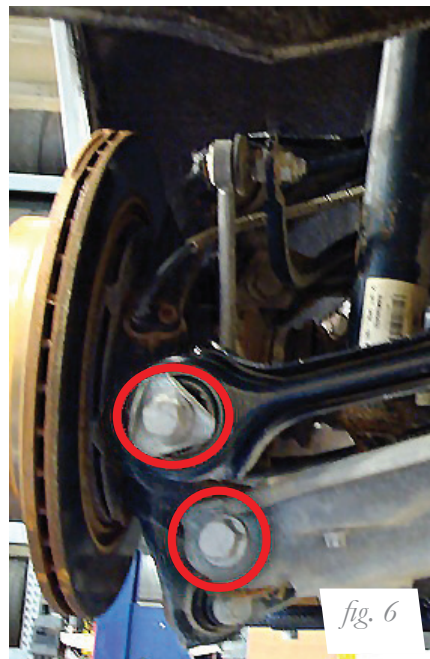

4. Unbolt and remove the toe link from the hub and sub-frame (fig. 7).

5. Within the trunk, remove the shock rod nut and remove the shock from the vehicle (fig. 8). Retain the lower isolator and rubber gasket that the shock rod passes through within the wheel housing (fig. 9).



fig. 8



fig. 9

6. If installing the kit without rear shocks, proceed to the “Assembling the Air Spring Upper Bracket and Air Fitting” section. With the rod nut removed (fig. 10), peel the micro cellular isolator from the rod nut washer and retain this isolator for future use (figs. 11 and 12). Take care not to damage the isolator during the removal process. The nut and washer will not be used when installing Air Lift rear shocks.



fig. 10



fig. 11

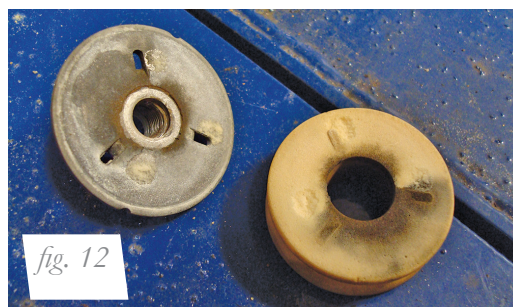

fig. 12

ASSEMBLING THE AIR SPRING UPPER BRACKET AND AIR FITTING

1. Apply thread sealant to the chosen air fitting threads and install into the air spring port. Torque 1 and 3/4 turns beyond hand tight.
2. Place the roll plate over the air spring followed by the upper mount spacer (fig. 13). Attach with two bolts and lock washers. Torque to 27 Nm (20 ft-lbs.) There are two mounting positions for the upper spacer to mount to the air spring. Best practice is to have the air fitting located on the forward side the vehicle, with the air line outlet facing rearward. This helps protect the air line connection. Mount the air spring so that it is positioned away from the wheel, toward the cross-member fig. 14).



fig. 13

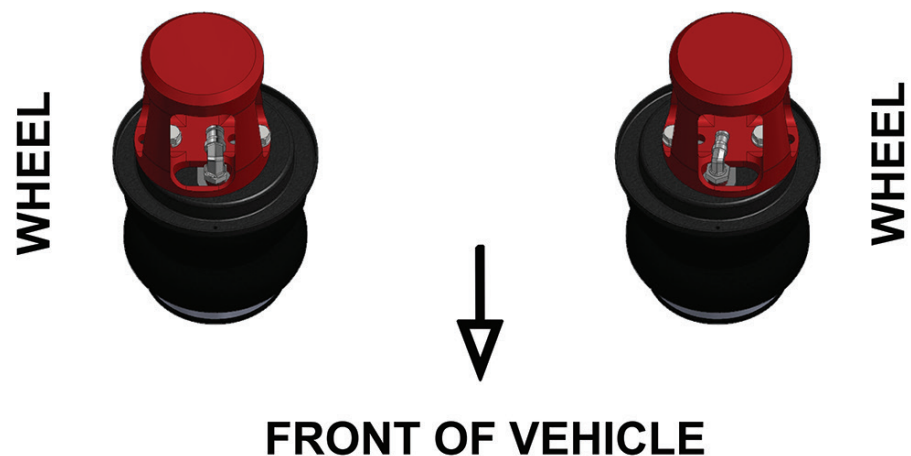

fig. 14

INSTALLING THE AIR SUSPENSION

1. Attach the supplied lower control arm to the hub assembly and the sub-frame (figs. 15 and 16). Do not torque bolts at this time.



2. Attach the headlight alignment linkage to the control arm (fig. 17).



3. Place the air spring assembly with the remaining roll plate on the lower control arm (fig. 18). Bolt the air spring in place by assembling a lock washer and bolt (H) through the control arm. Torque to 27 Nm (20 ft-lbs.) The upper mount is offset to properly position the air spring in the chassis (fig. 19). Align the assembly so the air spring is closest to the sub-frame. The air spring must be positioned furthest inboard away from the shock and wheel. Then insert the air spring spacer into the coil spring perch.



CAUTION

4. Snip the zip ties from the toe link. The toe link bushing spacers must be installed opposite the bend of the link (fig. 20). Attach the link to the hub assembly and sub-frame with the bend rearward and directed downward (figs. 21 and 22). Do not torque bolts at this time.

IF THE BEND IS DIRECTED UPWARD, CONTACT WITH THE SUB-FRAME AND TOE LINK WILL OCCUR. IF THE BEND IS FORWARD OR IF THE BUSHING SPACERS ARE INSTALLED INCORRECTLY, AIR SPRING CONTACT WITH THE TOE LINK WILL OCCUR. THIS CONTACT WILL CAUSE DEGRADATION OF THE AIR SPRING AND VOID THE WARRANTY.

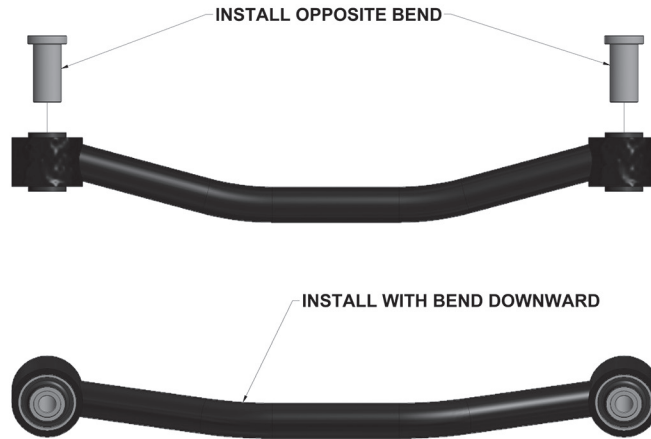

fig. 20



fig. 21



fig. 22

INSTALLING SHOCKS

NOTE

When purchasing kit 78609 without rear shocks, you must acquire BMW E9X M3 shocks because of the way the shock mounts to the lower control arm. Standard E8X/E9X rear shocks will not work with this kit.

1. Insert the shock rod with large washer through the lower isolator and gasket (fig. 23). Install through the upper shock mount (fig. 24). Within the trunk, apply the upper isolator (fig. 25) followed by the second large flat washer (fig. 26) and nyloc nut (fig. 27). Torque the nyloc nut to 27Nm (20lbs ft).



2. Align the lower shock eye with the control arm shock mount and install the supplied bolt and washer (fig. 28). Apply another washer, and nyloc nut to the other side (fig. 29). Do not torque at this time.

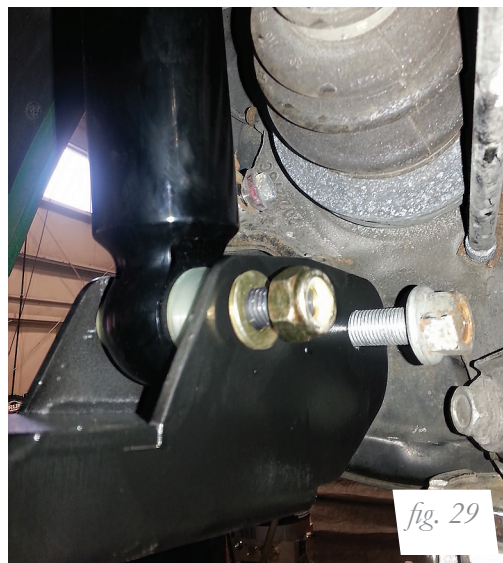

3. Fully compress the suspension using a jack. With the suspension compressed, review the best routing for the air line that is clear of all suspension components and axle. Routing should also allow for the suspension to extend without kinking or pulling the line tight or rubbing on other components. Check clearances to all other components.

4. With the suspension fully compressed, take a measurement from the fender to some reference point – typically the center of the axle. Record this measurement as Max Compression.
5. Cycle the suspension to Max Extension and record the measurement from the same reference points.
6. Add ME and MC then divide by 2. Set the suspension to this point. This position will give 50% stroke in either direction and is a starting point for ride height (fig. 30).

Formula for Calculating Ride Height

$$(ME+MC) \div 2 = \text{MID STROKE}$$

fig. 30

7. With the suspension at this position, loosen, then re-torque the lower control arm bolts to manufacturer's specifications (Table 1).

Torque Specifications			
Location	Nm	lb-ft	lb-in
Toe Link to Sub Frame	100	74	
Toe Link to Hub	100	74	
Lower Control Arm to Sub Frame	165	122	
Lower Control Arm to Hub	165	122	
Trailing Arm to Sub Frame	100	74	
Trailing Arm to Hub	100 + 90°	74 + 90°	
Wishbone to Sub Frame	100	74	
Wishbone to Hub	100 + 90°	74 + 90°	
Shock Rod Nyloc Nut	27	20	
Shock Eye Nut/Bolt	132	97	
Headlight Alignment Nut	5		44
Air spring bolts	27	20	
Wheels	120	89	
Air Fitting (with sealant)	1.5-3.0 turns beyond hand tight		

Table 1

DAMPING ADJUSTMENT

The struts in this kit have 30 settings, or “clicks”, of adjustable compression and rebound damping characteristics. Damping is changed through the strut rod using the supplied adjuster (figs. 31 & 32) or a 3mm allen wrench.

Turn the adjuster clockwise and the damping settings are hardened. Turn the adjuster counterclockwise and the damping is softened.

Each shock is preset to “-20 clicks”. This means that the shock is adjusted 20 clicks away from full stiff. Counting down from full stiff is the preferred method of keeping track of, or setting, damping. This setting was developed on a BMW 135i and may need to be adjusted to different vehicles and driving characteristics.

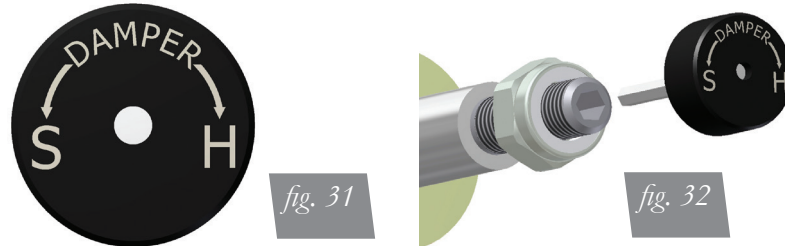

ALIGNING THE VEHICLE

1. Using the control system, set the vehicle height to the new custom ride height.
2. If the custom ride height is lower than stock, we recommend loosening all pivot points (bolts, nuts) on any control arm, strut arm or radius rod that contains bushings. Once they have been loosened, re-torque to stock specifications.

NOTE

It may be necessary to cycle the suspension to loosen the bushing up from its mount. This will help re-orient the bushing at its new position based on the custom ride height.

ADJUSTING EXTENDED OR DROP HEIGHT USING LOWER MOUNT

Your struts have been pre-set at the factory to provide maximum drop height while maintaining adequate tire clearance to the air spring. If you wish to gain more extended height (lift), which is the same as reducing drop height, or want to lower the chassis further and there is still adjustment available at the lower mount, please use the following procedure:

1. Support the vehicle with jack stands or a hoist at approved lifting points.
2. Remove the wheel.
3. Using the supplied spanner wrench, loosen the lower locking collar (fig. 33).

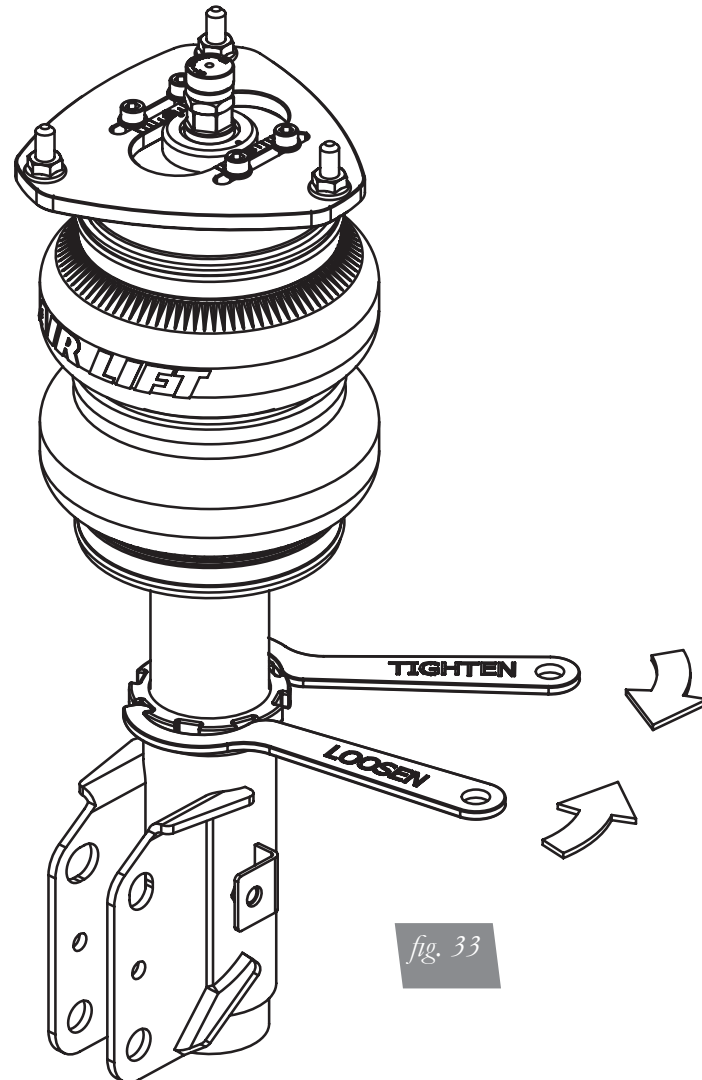

4. Deflate the air spring to 0 PSI on the corner you are adjusting.
5. Disconnect lower mount from suspension.
6. Spin the lower mount to the desired location.

NOTE

Not all models will have further drop height available.

7. Re-install lower mount to suspension and torque fasteners.
8. Tighten the lower locking collar to the lower mount using significant force.

CAUTION

WHEN ADJUSTING HEIGHT UPWARDS, MAKE SURE THAT THE STRUT BODY ENGAGES ALL THE THREADS OF THE LOWER MOUNT (FIG. 34). WHEN ADJUSTING DOWNWARDS, MAKE SURE THERE IS ADEQUATE AIR SPRING CLEARANCE TO THE TIRE/WHEEL ASSEMBLY. CLEARANCE MUST BE CHECKED WITH SYSTEM FULLY DEFLATED AS WELL AS FULLY INFLATED TO ENSURE THAT NO RUBBING OCCURS. FAILURE TO MAINTAIN ADEQUATE CLEARANCE CAN RESULT IN AIR SPRING FAILURE AND WILL NOT BE COVERED UNDER WARRANTY.

CAUTION

DO NOT ADJUST HEIGHT BY SPINNING AIR SPRING ON STRUT! DOING SO MAY CAUSE AN AIR LEAK AND COMPROMISE THE ASSEMBLY.

FOR STRUTS:

FOR SHOCKS:

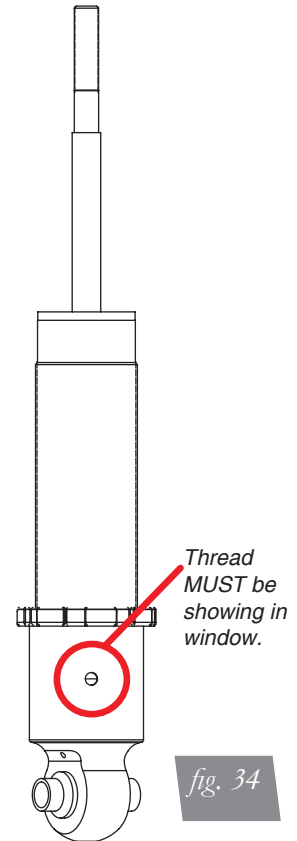
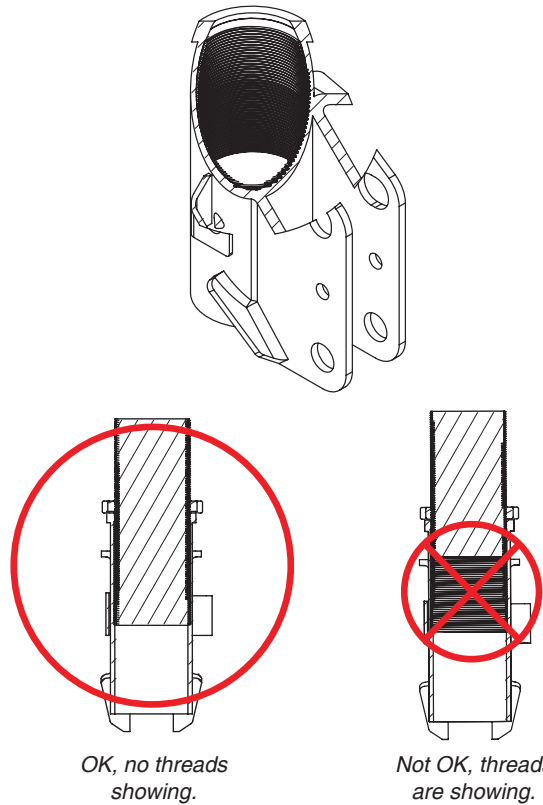

fig. 34

Before Operating

CAUTION

MAKE SURE THE FRONT WHEELS ARE STRAIGHT WHEN DEFLATING AND REINFLATING AIR BAGS.

1. Inflate and deflate the system (do not exceed 125 PSI) to check for clearance or binding issues. With the air springs deflated, check clearances on everything so as not to pinch brake lines, vent tubes, etc. Clear lines if necessary.
2. Inflate the air springs to 75-90 PSI and check all connections for leaks.
3. Air Lift part #27669 or #27671, AutoPilot V2 Air Management System, is highly recommended for this product.
4. Please familiarize yourself further with this product by reading the Product Use, Maintenance and Servicing section.

INSTALLATION CHECKLIST

- Clearance test — Inflate the air springs to 75-90 PSI and make sure there is at least ½" clearance from anything that might rub against each sleeve. Be sure to check the tire, brake drum, frame, shock absorbers and brake cables.
- Leak test before road test — Inflate the air springs to 75-90 PSI and check all connections for leaks. All leaks must be eliminated before the vehicle is road tested.
- Heat test — Be sure there is sufficient clearance from heat sources, at least 6" for air springs and air lines. If a heat shield was included in the kit, install it. If there is no heat shield, but one is required, call Air Lift customer service at (800) 248-0892.
- Fastener test — Recheck all bolts for proper torque.
- Road test — The vehicle should be road tested after the preceding tests. Inflate the springs to recommended driving pressures. Drive the vehicle 10 miles and recheck for clearance, loose fasteners and air leaks.
- Operating instructions — If professionally installed, the installer should review the operating instructions with the owner. Be sure to provide the owner with all of the paperwork that came with the kit.

Technician's Signature _____

Date _____

POST-INSTALLATION CHECKLIST

- Overnight leak down test — Recheck air pressure after the vehicle has been used for 24 hours. If the pressure has dropped more than 5 PSI, then there is a leak that must be fixed. Either fix the leak yourself or return to the installer for service.
- Air pressure requirements — Regardless of load, the air pressure should always be adjusted to maintain adequate ride height at all times while driving.
- Thirty day or 500 mile test — Recheck the air spring system after 30 days or 500 miles, whichever comes first. If any part shows signs of rubbing or abrasion, the source should be identified and moved, if possible. If it is not possible to relocate the cause of the abrasion, the air spring may need to be remounted. If professionally installed, the installer should be consulted. Check all fasteners for tightness.

Product Use, Maintenance and Servicing

Suggested Driving Air Pressure	Maximum Air Pressure
70 PSI	125 PSI
FAILURE TO MAINTAIN ADEQUATE MINIMUM PRESSURE (OR PRESSURE PROPORTIONAL TO LOAD) WILL RESULT IN BOTTOMING OUT, OVER-EXTENSION OR RUBBING AGAINST ANOTHER COMPONENT AND WILL VOID THE WARRANTY .	

MAINTENANCE GUIDELINES

NOTE

By following these steps, vehicle owners will obtain the longest life and best results from their air spring.

1. Check the air pressure before driving.
2. Never inflate beyond 125 PSI.
3. If you develop an air leak in the system, use a soapy water solution to check all air line connections, before deflating and removing the spring.
4. When increasing load, always adjust the air pressure to maintain normal ride height. Increase or decrease pressure from the system as necessary to attain normal ride height for optimal ride and handling. Remember that loads carried behind the axle (including tongue loads) require more leveling force (pressure) than those carried directly over the axle.

CAUTION

FOR YOUR SAFETY AND TO PREVENT DAMAGE TO YOUR VEHICLE, DO NOT EXCEED MAXIMUM GROSS VEHICLE WEIGHT RATING (GVWR), AS INDICATED BY THE VEHICLE MANUFACTURER. ALTHOUGH YOUR AIR SPRINGS ARE RATED AT A MAXIMUM INFLATION PRESSURE OF 125 PSI, THE AIR PRESSURE ACTUALLY NEEDED IS DEPENDENT ON YOUR LOAD.

5. Always add air to the springs in small quantities, checking the pressure frequently. Sleeves require less air volume than a tire and inflate quickly.
6. Should it become necessary to raise the vehicle by the frame, make sure the control system is turned off before lifting.

Troubleshooting Guide

1. Leak test the air line connections, the threaded connection into the air spring, and all fittings in the control system.
2. Inspect the air lines to be sure none are pinched. Tie straps may be too tight. Loosen or replace the strap and replace leaking components.
3. Inspect the air line for holes and cracks. Replace as needed.
4. Look for a kink or fold in the air line. Reroute as needed.

If the preceding steps do not solve the problem, it is possibly caused by a failed air spring — either a factory defect or an operating problem. Please call Air Lift at (800) 248-0892 for assistance.

Frequently Asked Questions

Q. Will installing air springs increase the weight ratings of a vehicle?

No. Adding air springs will not change the weight ratings (GAWR, GCWR and/or GVWR) of a vehicle. Exceeding the GVWR is dangerous and voids the Air Lift warranty.

Q. How long should air springs last?

If the air springs are properly installed and maintained they can last indefinitely.

Q. Will raising the vehicle on a hoist for service work damage the air springs?

No. The vehicle can be lifted on a hoist for short-term service work such as tire rotation or oil changes. However, if the vehicle will be on the hoist for a prolonged period of time, support the axle with jack stands in order to take the tension off of the air springs.

Tuning the Air Pressure

Pressure determination comes down to three things — level vehicle, ride comfort, and stability.

1. Level vehicle

If the vehicle's headlights are shining into the trees or the vehicle is leaning to one side, then it is not level. Raise the air pressure to correct either of these problems and level the vehicle.

2. Ride comfort

If the vehicle has a rough or harsh ride it may be due to either too much pressure or not enough. Try different pressures to determine the best ride comfort. See Air Lift suggested driving air pressure.

3. Stability

Stability translates into safety and should be the priority, meaning the driver may need to sacrifice a perfectly level and comfortable ride. Stability issues include roll control, bounce, dive during braking and sponginess. Tuning out these problems usually requires additional air pressure, strut damping, or both.

Checking for leaks

1. Inflate the air spring to 80 PSI.
2. Spray all connections and the inflation valves with a solution of 1/5 liquid dish soap and 4/5 water. Spot leaks easily by looking for bubbles in the soapy water.
3. After the test, deflate the springs to the minimum pressure required to restore the system to normal ride height.
4. Check the air pressure again after 24 hours. A 2-4 PSI loss after initial installation is normal. Retest for leaks if the loss is more than 5 PSI.

Fixing Leaks

1. If there is a problem with a swivel fitting:
 - a. Check the air line connection by deflating the spring and removing the line by pulling the collar against the fitting and pulling firmly on the air line. Trim 1" off the end of the air line. Be sure the cut is clean and square (see fig. 35). Reinsert the air line into the push-to-connect fitting.
 - b. Check the threaded connection by tightening the swivel fitting another ½ turn. If it still leaks, deflate the air spring, remove the fitting, and re-coat the threads with thread sealant. Reinstall by hand tightening as much as possible and then use a wrench for an additional two turns.
2. If the preceding steps have not resolved the problem, call Air Lift customer service at (800) 248-0892.

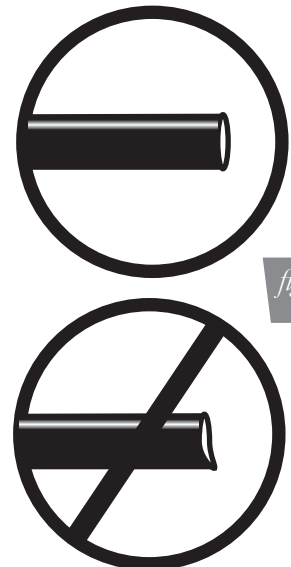

fig. 35

Warranty and Returns Policy

Air Lift Performance warrants its performance products for one year to the original purchaser against manufacturing defects one year from the date of purchase when used on cars and trucks as specified under normal operating conditions. The warranty does not apply to products that have been improperly applied, improperly installed, or which have not been maintained in accordance with installation instructions furnished with all products. The consumer will be responsible for removing (labor charges) the defective product from the vehicle and returning it, transportation costs prepaid, to the dealer from which it was purchased or to Air Lift Performance for verification.

Air Lift will repair or replace, at its option, defective products or components. A minimum \$10.00 shipping and handling charge will apply to all warranty claims. Before returning any defective product, you must call Air Lift at (800) 248-0892 in the U.S. and Canada (elsewhere, (517) 322-2144) for a Returned Materials Authorization (RMA) number. Returns to Air Lift can be sent to: Air Lift Performance • 2727 Snow Road • Lansing, MI • 48917.

Product failures resulting from abnormal use or misuse are excluded from this warranty. The loss of use of the product, loss of time, inconvenience, commercial loss or consequential damages is not covered. The consumer is responsible for installation/reinstallation (labor charges) of the product. Air Lift Performance reserves the right to change the design of any product without assuming any obligation to modify any product previously manufactured.

This warranty gives you specific legal rights and you may also have other rights that may vary from state-to-state. Some states do not allow limitations on how long an implied warranty lasts or allow the exclusion or limitation of incidental or consequential damages. The above limitation or exclusion may not apply to you. There are no warranties, expressed or implied including any implied warranties of merchantability and fitness, which extend beyond this warranty period. There are no warranties that extend beyond the description on the face hereof. Seller disclaims the implied warranty of merchantability. (Dated proof of purchase required.)

Replacement Information

If you need replacement parts, contact the local dealer or call Air Lift customer service at (800) 248-0892. Most parts are immediately available and can be shipped the same day.

Contact Air Lift Performance customer service at (800) 248-0892 first if:

- Parts are missing from the kit.
- Need technical assistance on installation or operation.
- Broken or defective parts in the kit.
- Wrong parts in the kit.
- Have a warranty claim or question.

Contact the retailer where the kit was purchased:

- If it is necessary to return or exchange the kit for any reason.
- If there is a problem with shipping if shipped from the retailer.
- If there is a problem with the price.

Contact Information

If you have any questions, comments or need technical assistance contact our customer service department by calling (800) 248-0892, Monday through Friday. For calls from outside the USA or Canada, our local number is (517) 322-2144. You may also contact customer service anytime by e-mail at techsupport@airliftperformance.com.

For inquiries by mail, our address is PO Box 80167, Lansing, MI 48908-0167. Our shipping address for returns is 2727 Snow Road, Lansing, MI 48917.

You may also contact our sales team anytime by e-mail at sales@airliftperformance.com or on the web at www.airliftperformance.com.

Notes

Notes

Notes

Need Help?

Contact our customer service department by calling (800) 248-0892, Monday through Friday. For calls from outside the USA or Canada, our local number is (517) 322-2144.



Thank you for purchasing Air Lift Performance products!

Air Lift Performance • 2727 Snow Road • Lansing, MI 48917 or PO Box 80167 • Lansing, MI 48908-0167
Toll Free (800) 248-0892 • Local (517) 322-2144 • Fax (517) 322-0240 • www.airliftperformance.com

Printed in
the USA

Kit Details

27671



HARDWARE LIST

Part #	Description	Qty	Part #	Description	Qty
72605	4pt Fast Air Manifold - 1/4"	1	21773	3/8" MNPT X 1/8" MNPT Adapter	1
27042	Gen 3 Display	1	21999	1/8" MNPT X 1/4" PTC Elbow	2
26498-002	Electrical Harness - FastAir	1	21633	Push Lock Valve	1
24672	Fuse, spade 3amp	1	21585	1/4" Pipe Plug	1
24547	Fuse, spade, 30amp	1	20937	Polyurethane Filter Drain Hose	5ft
24500	ATC Fuse holder w/ cap	2	20946	DOT 1/4" Air Line	60ft
24645	16GA Butt Connector	1	17263	1/4-14 x 1 Self Tapping Screw	3
24752	12-10GA Butt Connector	3	18444	3/8" Flat Washer	8
24748	12GA Ring Terminal 3/8"	2	17188	3/8-16 x 1.25 Hex Cap Screw	4
24524	Female Spade Terminal	1	18435	3/8-16 Nyloc Nut	4
24595	12GA Female Spade Terminal	1	11517	Miniature Filter	1
24561	Adaptor, Mini Fuse	1	11217	P Clamp	1
24542	ATC/ATO Fuse Adaptor	1	17173	1/4"-14 X 3/4" Self Tapping Screw	1
23586	Thread Sealant	1	16380	VIAIR 380C Compressor (200 psi)	1
21043	1/4" MNPT X 1/4" PTC Elbow	1	11955	4 Gallon Aluminum Air Tank	1
21847	3/8" MNPT X 1/4" PTC Elbow	1	10466	8" Zip Tie	10
21737	3/8" Pipe Plug	1	10530	Air Line Cutter	1



Missing or damaged parts? Call Air Lift customer service at (800) 248-0892 for a replacement part.

Air Lift™ **PERFORMANCE**

AutoPilot V2™ PATENT PENDING



AIR LIFT **PERFORMANCE**™

INSTALLATION GUIDE

For maximum effectiveness and safety, please read these instructions completely before proceeding with installation.

Failure to read these instructions can result in an incorrect installation.



TABLE OF CONTENTS

Introduction	2
Notation Explanation	2
Installing the AutoPilot V2 Kit	3
Install Components	3
Install Harness	4
Install Air Lines	5
NPT Assembly Instructions	6
Helpful Tips: Air Line and Fittings	6
Setup and Calibration	6
System Calibration and Settings	7
Program Presets	9
Operating the System	12
Troubleshooting Guide	13
Leak Testing and Detection	13
Electrical Schematic	14
AutoPilot V2 Remote Control Unit Dimensions	15
Manifold Template	17
16380 Compressor Template	19
Warranty and Returns Policy	21
Replacement Information	21
Contact Information	21



Introduction

The purpose of this publication is to assist with the installation, operation and troubleshooting of the AutoPilot V2 kit.

It is important to read and understand the entire installation guide before beginning installation or performing any maintenance, service or repair. The information includes step-by-step installation information, installation templates and a troubleshooting guide.

Air Lift Company reserves the right to make changes and improvements to its products and publications at any time. For the latest version of this manual, contact Air Lift Performance at (800) 248-0892 or visit our website at www.airliftperformance.com.

NOTATION EXPLANATION

Hazard notations appear in various locations in this publication. Information which is highlighted by one of these notations must be observed to help minimize risk of personal injury or possible improper installation which may render the vehicle unsafe. Notes are used to help emphasize areas of procedural importance and provide helpful suggestions. The following definitions explain the use of these notations as they appear throughout this guide.

 **DANGER**

INDICATES IMMEDIATE HAZARDS WHICH WILL RESULT IN SEVERE PERSONAL INJURY OR DEATH.

 **WARNING**

INDICATES HAZARDS OR UNSAFE PRACTICES WHICH COULD RESULT IN SEVERE PERSONAL INJURY OR DEATH.

 **CAUTION**

INDICATES HAZARDS OR UNSAFE PRACTICES WHICH COULD RESULT IN DAMAGE TO THE MACHINE OR MINOR PERSONAL INJURY.

NOTE

Indicates a procedure, practice or hint which is important to highlight.

Installing the AutoPilot V2 Kit

INSTALL COMPONENTS

NOTE

For a complete schematic, please see fig. 15. (pages 10-11)

CAUTION

BEST PRACTICE IS TO LOCATE THE MANIFOLD UNIT INSIDE THE VEHICLE. IF EXTERNAL MOUNTING IS DESIRED, THE MANIFOLD MUST BE LOCATED IN AN AREA SHIELDED FROM DIRECT WATER SPRAY FROM TIRES OR CAR WASHES. THE MANIFOLD SHOULD BE CONSIDERED “WATER RESISTANT” NOT “WATERPROOF”.

Layout

1. Plan component location first. Ideally, the manifold should be located above the compressor and tank if possible to avoid compressor ingested water from gathering in the manifold. This is most important for vehicles operated in below freezing climates.
2. Prior to mounting components, check to make sure:
 - the electrical harness connections will reach the manifold and compressor.
 - the compressor leader hose will reach the tank.
 - the air lines will route cleanly through the vehicle without kinking or bending.

NOTE

Be sure to install all components as far as possible from any heat sources. Plan and prepare harness and air line routing thru the vehicle. Eliminate all sharp edges that could chafe. Use grommets when passing through compartment walls.

Prepare and install the compressor

1. Prepare the compressor intake. If the compressor body is mounted inside the vehicle, attach filter to port on end of compressor (fig. 15). If compressor is located outside the vehicle, snorkel inlet filter to dry location inside vehicle using components supplied with compressor.
2. Center punch and drill four holes using the template on page 19.
3. Attach using the hardware supplied with the compressor.

NOTE

If the harness must be lengthened, use properly sized butt connectors and wire. If extending the power/ground wires, use 8AWG wire minimum or contact Air Lift for more information.

The supplied harness is only capable of powering a single compressor. If installing dual compressors, a second dedicated power wire is required. Consult the Electrical Schematic section for proper wiring, and contact Air Lift for an optional second compressor harness (part number: 27679).

Manifold

1. Position the manifold in a desired location. Make sure the manifold mounting surface is flat.

NOTE

Mount the manifold to the body either horizontally (fig. 1a) or vertically with the ports facing toward the ground (fig. 1b). Do not mount the manifold upside down (fig. 1c). Proper manifold mounting will help prevent water from settling in areas sensitive to freezing.

2. Fasten the manifold using the two self-tapping screws. **If the mounting surface is not flat, add washers to space the manifold up over surface irregularities.**
3. If needed, a manifold mounting template can be found on page 17.

This represents the top of the vehicle frame or any custom setup (and is the same for figures 1b and 1c).

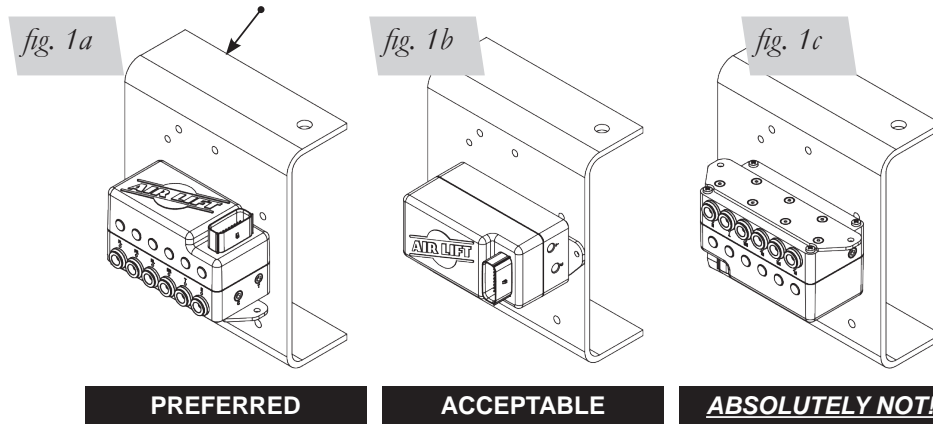

NOTE

Air compressors intake moisture (humidity) from the outside air source and will deposit water in the air tank. The AutoPilot V2 system includes a filter that will greatly reduce the potential for moisture to enter the manifold, however, tanks must be regularly purged to eliminate the possibility of water entering the manifold. Be sure to provide easy access to tank drain/fill valve (preferably outside the vehicle). This is an automatic draining filter and does not need servicing. If you find this filter to be plugged, it will need to be replaced. If using an engine driven compressor, the life of the provided filter may be reduced due to the increased potential for oil being introduced into the system.

Tank pre-assembly (see fig. 15)

1. Per the diagram on pages 10 and 11, install the filter to the tank with supplied fittings/adapters or remotely mount the filter using the supplied fittings, P-clamp and self tapping screw. Be sure to mount the filter in the correct orientation.

NOTE

This is a one-way filter. The arrow at the top should be pointing in the direction of the air flow from the tank to the manifold (fig. 15b).

This is an automatic draining filter that does not require servicing. If you find this filter to be plugged, it will need to be replaced. The tank will need to be purged periodically to reduce/eliminate the potential of moisture entering the manifold.

Tank install (see fig. 15)

1. Using the tank feet as a template, drill holes for hardware assembly.
2. Attach the tank using the supplied hardware.
3. Cut an appropriate length of hose from the manifold port T, to the PTC fitting on the filter.
4. Route the drain/fill air line with a schrader valve (preferably outside the vehicle).
5. Install the supplied drain tube (soft hose) to the bottom of the filter and route to a location outside of the vehicle.

NOTE

When cutting plastic air line, only use a standard hose cutter like (Air Lift part number 10530) or razorblade. Cut all hose ends square and as smoothly as possible. See hose cutting tips on page 6.

INSTALL HARNESS

1. Disconnect the battery ground while installing the system.
2. Compressor / manifold connections (see fig. 15)
 - Attach the manifold connector, it will “click” into place once fully seated.
 - Mount the compressor relay in a preferred location using a self-tapping screw.
 - Cut off the spade and eyelet from the compressor power and ground wires.
 - Strip 1/4” of wire casing from the compressor wires.
 - Strip 1/4” of wire casing from the black and pink harness wires.
 - NOTE: Use an appropriate terminal crimp tool to ensure a good connection.

- Using a butt connector attach the RED compressor wire to the PINK harness wire.
 - Using a butt connector attach the BLACK compressor wire to the BLACK harness wire.
 - Carefully apply heat (preferably with a heat gun) to seal these connections.
3. Battery / ignition connections (see fig. 15)
 - Identify the power, ground, + ignition leg of the harness.
 - Ground: 10AWG black wire; Power: 10AWG red wire; Ignition: 18AWG pink wire.
 - Route power and ground leg of the harness free from any heat source to the battery.
 - Using a butt connector attach the red wire to a fuse holder.
 - Attach an 3/8" eyelet to the other end of the fuse holder and attach to the positive battery (+) terminal.
 - Attach an 3/8" eyelet to the black wire and attach to the battery ground.
 - Route the 18AWG pink wire to a key switched IGNITION source that remains on during cranking. Examples include: ECU, fuel pump.

NOTE

Do not select an accessory source. If the AutoPilot V2 display shuts off while starting the vehicle, this is not a true ignition source.

- Using a butt connector attach the pink ignition wire to a fuse holder.
 - Select ignition source and attach the fused ignition wire.
 - Use fuse adaptors as necessary.
4. Display
 - Route the display cable as desired to the preferred operating location.
 - Attach the display cable to the main harness cable (small white 3 cavity connector).
 5. Reconnect the battery.

INSTALL AIR LINES

NOTE

Use a standard hose cutter (Air Lift part number 10530) or razorblade. Cut all hose ends square and as smoothly as possible.

1. Route and attach the air lines to the air springs.
 - Route air lines free from abrasive edges and heat sources.
2. Attach manifold port **FL** to the front, drivers side left spring.
3. Attach manifold port **FR** to the front, passengers side right spring.
4. Attach manifold port **RL** to the rear, drivers side left spring.
5. Attach manifold port **RR** to the rear, passengers side right spring.
6. Attach manifold port **T** to the PTC fitting previously installed on the filter.
7. Manifold port **E** is the exhaust port.
 - Port E can be left open, or routed to a preferred exhaust location.

NOTE

Air lines should be pushed in firmly, with a slight back and forth rotational twist – check the connection by pulling on each line to verify a robust connection.

Release the air line from the fitting by releasing air, pushing on the line, depressing the ring towards the fitting, and then pulling the hose out of the fitting.

NPT ASSEMBLY INSTRUCTIONS

1. Inspect the port and fitting ensuring both are free of contaminants and excessive burrs and nicks.
2. Apply a stripe of liquid pipe sealant around the male threads leaving the first two threads uncovered.
3. Screw finger tight into the port.
4. Wrench tighten the fitting to the correct turns past finger tight position (see table 1 located on page 6).



NEVER BACK OFF AN INSTALLED PIPE FITTING TO ACHIEVE PROPER ALIGNMENT. LOOSENING INSTALLED PIPE FITTINGS WILL CORRUPT THE SEAL AND CONTRIBUTE TO LEAKAGE AND FAILURE.

Torque Specifications		
Fitting Size	Turns Past Finger Tight	Torque lb/ft
1/8" NPT	1.5 - 3.0	12
1/4" NPT	1.5 - 3.0	25
3/8" NPT	1.5 - 3.0	40
1/2" NPT	1.5 - 3.0	54
3/4" NPT	1.5 - 3.0	78
1" NPT	1 - 2.5	112
1 1/4" NPT	1 - 2.5	154
1 1/2" NPT	1 - 2.5	211
2" NPT	1 - 2.5	300

Table 1

HELPFUL TIPS: AIR LINE AND FITTINGS

1. Minimum hose bend radius
 - 3/8" hose = 1.5" hose bend radius.
 - 1/4" hose = 1" hose bend radius.
2. Hose to fitting
 - No side loading on fitting from hose.
 - Hose straight for 1" before bending.
3. Hose cutting
 - Cut hose perpendicular to hose length.
 - Inspect hose for scratches that run lengthwise on hose prior to insertion.
 - Use proper hose cutter, cigar cutter, or razor on flat surface.
4. DOT/SAEJ844 air brake hose data
 - Maximum working pressure of 175 PSI.
 - Not to be used for frame (body) to un-sprung mass connection, use a braided leader hose for this moving connection.

Compressor Tank Pressure		
Viair	Air Lift P/N	Max. Tank Pressure
380C	16380	175
400C	16400	150
444C	16444	175
450C	16450	150
480C	16480	175

Table 2

Setup and Calibration

AutoPilot V2 is an advanced pressure-based air suspension control system, that uses state-of-the-art software algorithms to calibrate or map the control system to your vehicle. Once the system is calibrated, the algorithm predicts required "valve open time" to move the air suspension to achieve preset target pressures. AutoPilot V2 has 8 programmable presets, allowing the user to input 8 different combinations of the 4 corner air spring pressures.

After installing AutoPilot V2 in your vehicle, please follow the steps below to properly setup your new system. If changes are made after installing and calibrating the system such as changes to air springs, lines, tank, compressor, or other vehicle modifications, the system must be recalibrated to maintain accuracy.

SYSTEM CALIBRATION AND SETTINGS

1. Key-on/power up, and compressor should come on to fill the tank. Check to make sure system is triggered by IGNITION source. While starting the engine, the system should be ON. If not, please refer back to the “Install Harness” section.
2. Press buttons 1 and 5 simultaneously (1+5) and hold for 5-10 seconds until settings and diagnostics mode main page appears (fig. 3).

fig. 2

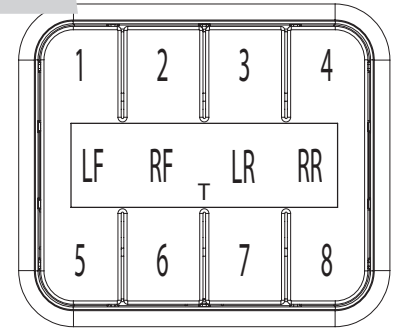

Button Definition

Tank Adjust (Maximum System PSI)

Press button 1 (TANK ADJUST). Set tank pressure preference by pressing MAX up/down buttons simultaneously (fig. 4). The MAX value sets compressor cut-off pressure. Press buttons (1+5) simultaneously to exit to settings and diagnostics mode.

fig. 3

```

1. TANK ADJUST
2. CALIBRATE
3. BACKLIGHT
4. PRESET MAIN ▾
    
```

NOTE

MIN tank pressure will follow MAX within 15 PSI to provide further accuracy.

If tank MAX settings are changed, a system recalibration is necessary for optimal performance. Max tank pressures for various compressors can be found in table 2.

fig. 4

```

      ▲
TANK MAX=175
      ▼
    
```

Calibrate to your vehicle

Press button 2 to enter CALIBRATE (fig. 3). Press button 1 SYSTEM CAL (fig. 5), follow instructions to calibrate AutoPilot V2 system to your vehicle. Once calibration is complete, Press buttons (1+5) simultaneously to exit to settings and diagnostics mode.

fig. 5

```

CALIBRATION MENU
1. SYSTEM CAL
2. ADJUST SYSTEM
    
```

CAUTION

DURING CALIBRATION THE SYSTEM WILL AUTOMATICALLY DEFLATE TO 0 PSI AND RAISE TO 100 PSI ON EACH AXLE AUTOMATICALLY. IF WHEELS EXTEND BEYOND FENDERS, VEHICLE DAMAGE MAY RESULT. CALIBRATION ON NARROW WHEELS THAT TUCK INSIDE THE FENDERS IS RECOMMENDED. ALSO, MAKE SURE VEHICLE BODYWORK WILL NOT BE HARMED IF ONE END IS RAISED TO 100 PSI AND THE OTHER IS AT ZERO. IF DAMAGE IS POSSIBLE, IT MAY BE BEST TO CALIBRATE BY SETTING VEHICLE ON BLOCKS OF WOOD (SAME HEIGHT) TO GIVE THE BODYWORK MORE CLEARANCE.

Backlight Setting

Press button 3 to enter BACKLIGHT (fig. 3). Set display backlight to your preference by pressing the + and – on R (Red), G (Green), B (Blue) (fig. 6). Press buttons (1+5) simultaneously to exit to settings and diagnostics mode.

fig. 6

```

+ + +
BACKLIGHT
R G B
- - -
    
```

Automatic Preset Maintenance

Press button 4 (fig. 3) to enter PRESET MAINTAIN. Press button 8 to turn ON or OFF (fig. 7). When ON, this function actively monitors air spring pressure and fills to maintain active preset pressure when average pressure drops below a threshold due to a system leak.

fig. 7

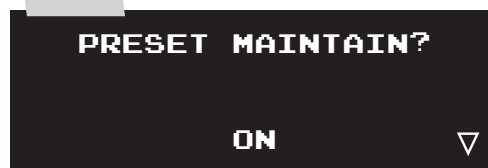

NOTE

This function will not exhaust pressure. If air spring pressure is higher than preset target, only the operator pressing the preset button again will activate the system to exhaust air spring pressure (for safety). Press buttons (1+5) simultaneously to exit.

PRESET MAINTAIN should be off for performance/track driving or if operating in extremely hilly areas.

Compressor Test / Run Time

Press button 5 to run a compressor test (fig. 8). This function will exhaust the tank to the specified MIN tank pressure, then turn ON the compressor and measure its inflate time to achieve MAX pressure (fig. 9). AutoPilot V2 will record this fill time, allowing the operator to compare future fill times to determine compressor performance. Press buttons (1+5) simultaneously to exit. Press button 6 (fig. 8) to view the number of hours the compressor has been running.

fig. 8

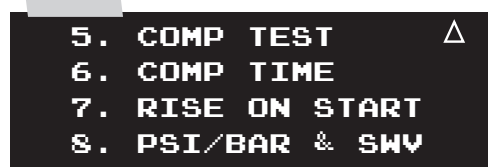

fig. 9

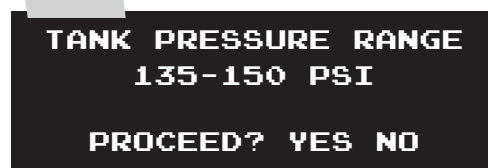
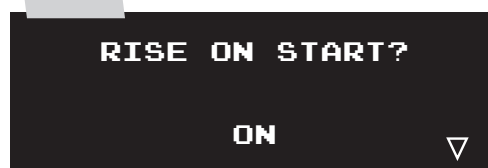

fig. 10



Rise on Start

Press button 7 (fig. 8) to enter RISE ON START (fig. 10). This function will automatically activate valves to achieve preset 1 target pressures when the vehicle is keyed-on. This function allows the operator to drive away seconds after vehicle is started. Press buttons (1+5) simultaneously to exit.

NOTE

This function only operates when the start-up pressures are BELOW the Preset 1 target pressures. The system will not deflate to achieve Preset 1 target

Set Units (PSI / BAR)

1. Press button 8 (fig. 8) to toggle between PSI and BAR pressure units and check software version. Press buttons (1+5) simultaneously to exit.
2. Press buttons (1+5) simultaneously to exit settings and diagnostics – you are now ready to create presets!

NOTE

BAR stands for DeciBar values.

Program Presets

Program Preset 1

NOTE

Preset 1 should always be entered as the desired ride pressure for the RISE ON START function.

Determine desired ride pressures: press buttons (1+5) simultaneously to toggle display to MANUAL mode. Manually activate each corner (see MANUAL mode section page 13) to achieve desired “normal driving” ride pressure (fig. 11). Program preset 1: press buttons (1+5) simultaneously to toggle display to PRESET mode (fig. 12). Press and hold button 1 for 3 seconds to set preset 1. Release button and actual air spring pressures will appear (fig. 12). Fine-tune the pressures by pressing up/down buttons. Press and hold to scroll. Press buttons (1+5) simultaneously to save and exit.

Program Presets 2-8

You are now free to program the additional 7 presets to desired pressures. Typical presets can be:

- “Low”: set pressures to the lowest possible pressures for extreme low driving stance.
- “Front up”: for speed bump or driveway clearance.
- “Rear up”: for added load of passengers, equipment.
- “Play”: for those that want to enjoy their air suspension freedom, AutoPilot V2 has a special function that recognizes side-to-side presets. When left side pressures are equal, and right side pressures are equal but >25PSI different than left, the algorithm will activate side to side instead of front to back. It will also equalize all air spring pressures when exiting the “play” preset, conserving air by using the high pressure side to inflate the low pressure side. Pairing two “play” presets together allows side-to-side activation that consumes far less air than manual mode activation would consume.

fig. 2

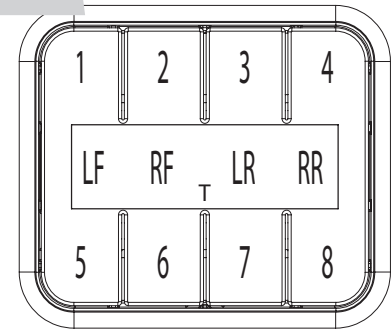

Button Definition

fig. 11



fig. 12



fig. 13



fig. 14

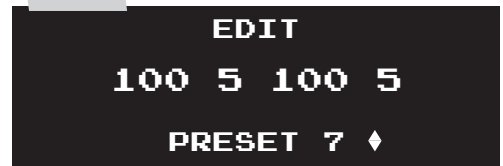

Sample Pressure Layouts for Play Mode (figs. 13 & 14)

fig. 15

Connect direct to battery

Preferred

NOTE: If not run to battery, voltage drop may reduce system performance and durability.

Ignition Source (on while cranking)

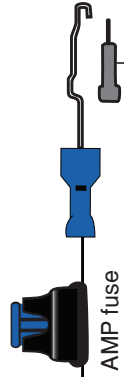

Examples:

- ECU • Fuel pump • etc.

Relay schematic reference

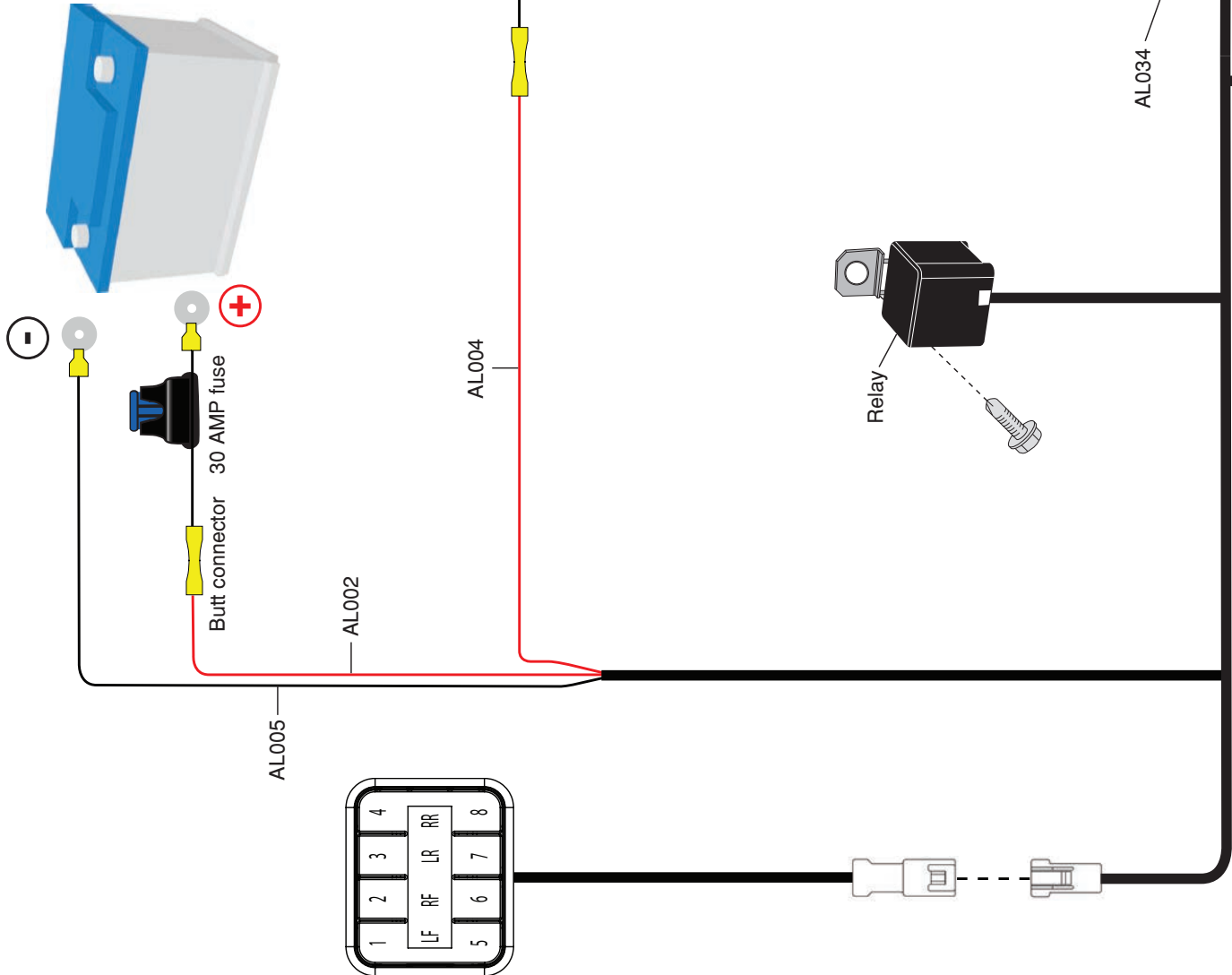
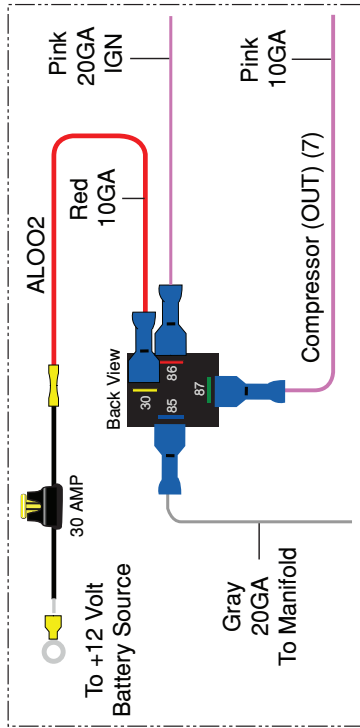

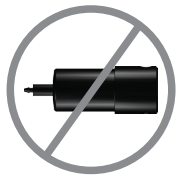
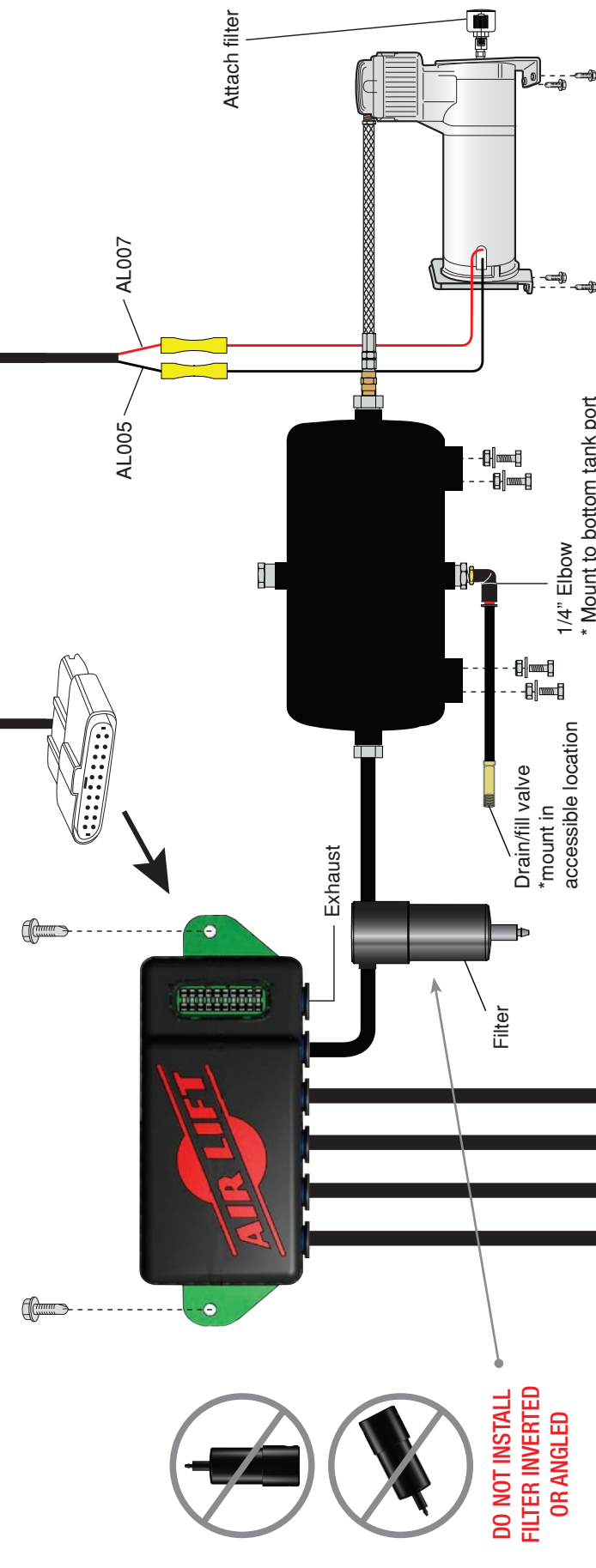

**DO NOT INSTALL
FILTER INVERTED
OR ANGLED**

FILTER INSTALLATION OPTIONS

OPTION #1 - INSTALL TO TANK

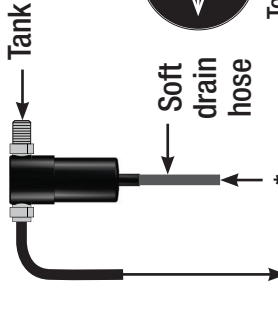

* This is a moisture drain and must drain to the outside of the vehicle.

OPTION #2 - REMOTELY MOUNT**

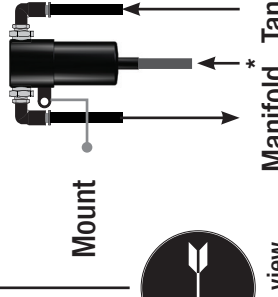

**This option must be used for tank P/N 10995



Top view of filter

fig. 15b

AIR LINE CUTTING

NOTE: Air Lift recommends using a hose cutting tool to ensure a proper cut (Air Lift part number 10530). If a hose connection has been disconnected the hose must be trimmed 1/2" back to provide for a leak free seal.

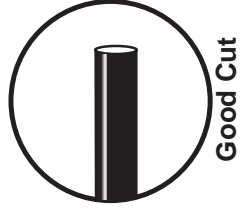

Good Cut



Poor Cut

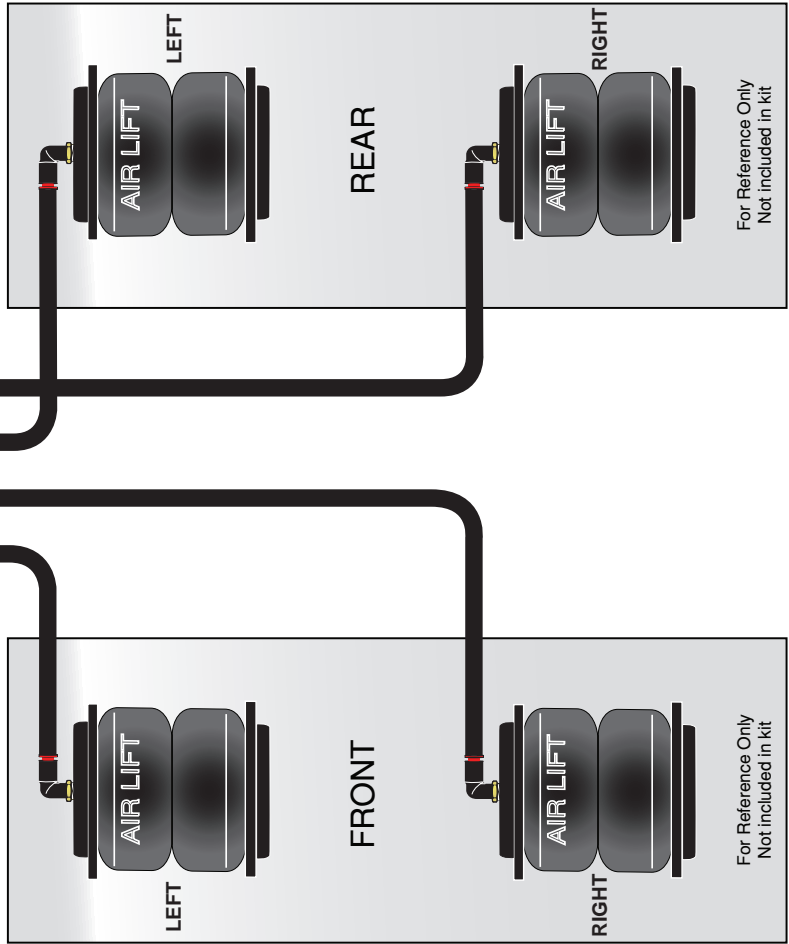

Operating the System

Now that your system is set up, it's time to use it. If changes are made after installing and calibrating the system such as changes to air springs, lines, tank, or compressor, the system must be recalibrated to maintain system accuracy.

There are two operational modes: PRESET and MANUAL. Pressing buttons (1+5) simultaneously will toggle between modes. After 10 seconds of non-use, the display enters standby where the LCD dims. Any button hit will "wake-up" the display and allow users to activate the system. See mode operation below for more details.

PRESET Mode

1. If display is sleeping, press any button once to "wake up" the display. If display is illuminated, go to the next step. Press of any button will display the programmed preset pressures for that button. Users can quickly view each preset prior to activating to make sure they are selecting the desired preset.
2. A 2nd button press of the same preset button within 2 seconds will activate it. The system will iterate up to 6 times to achieve the preset target pressures by +/- 3 PSI. The display shows PLEASE WAIT as it iterates, then will flash SUCCESSFUL when achieved or UNSUCCESSFUL if not able to achieve the target pressure window.
3. Micro adjust to ±1 PSI: If more accuracy is desired, double press the same preset and the system will refine pressures closer to target. This is often necessary when target preset pressures are LOWER than current pressure. Accuracy can be improved by rolling the vehicle straight while activating the preset.

NOTE

If the system indicates UNSUCCESSFUL, refer to troubleshooting guide on page 13.

PRESET Mode: Improve Accuracy

If system reads SUCCESSFUL but pressures are consistently lower or higher than target, you can improve first attempt accuracy by going to Calibration Menu (fig. 5) and pressing button 2. Adjust the ADJ value to a higher number if first attempt pressures are lower than target. Adjust the value to a lower number if first attempt pressures are higher than target.

CAUTION

WHEN A PRESET IS ACTIVATED THAT LOWERS THE VEHICLE SIGNIFICANTLY BELOW DRIVING HEIGHT, BE SURE TO HAVE THE FRONT WHEELS STEERED STRAIGHT AHEAD TO AVOID FENDER TO TIRE DAMAGE!

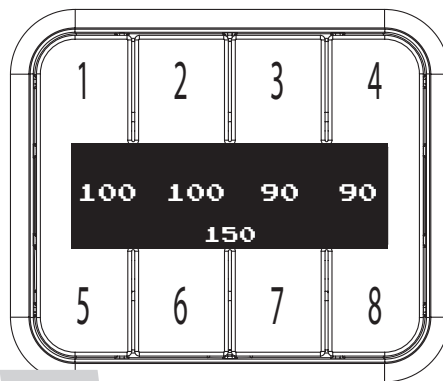

fig. 16

PRESET Mode

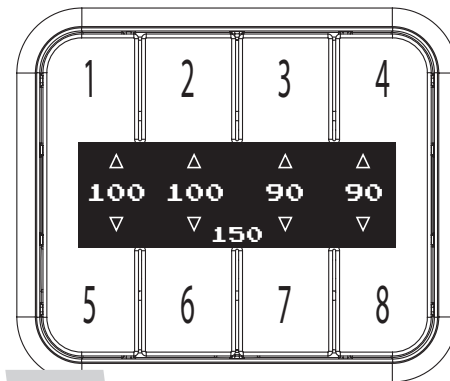

fig. 17

MANUAL Mode

MANUAL Mode

1. MANUAL mode allows the user to fill or exhaust each spring independently. The display will show arrows above and below the pressures to indicate manual control mode (fig. 17). The arrow will be solid when the spring is filling/exhausting, and outlined when not active.
2. The system detects button press time. For a very short (<0.1sec) duration press, the system will open the valves for a defined “burst”, changing pressure minimally so users can fine-tune their pressures. For a longer than 0.1 sec duration press, the valves open as long as you hold the button down. If a button is held active, the fill/exhaust will time out after 10 seconds.
 - Fill springs: buttons 1 - 4, Exhaust springs: buttons 5 - 8

Troubleshooting Guide

For further technical assistance please contact our customer service department by calling (800) 248-0892, Monday through Friday. For calls from outside the USA or Canada, our local number is (517) 322-2144.

PROBLEM	CAUSE	SOLUTION
<i>Compressor doesn't run</i>	There is a blown fuse or relay, bad ground, or poor electrical connections.	Replace the fuse, check the ground wire, or check the compressor connector
<i>Compressor runs all the time.</i>	The compressor relay is defective or there is a leak.	Replace the relay or locate the leak and repair.
<i>Air spring or tank leak.</i>	Fitting seal or air line is compromised.	Check to make sure air lines are seated in connectors. Inspect fittings with soapy water. Trim hose or re-seal fitting.
<i>Nothing happens when the vehicle is key-on ignition active</i>	There is a blown fuse or a poor connection.	Replace the fuses and check the electrical connections.
<i>The display does not light up.</i>	There is a blown fuse or a poor connection.	Replace the fuses and check the electrical connections.
<i>Compressors runs all the time but doesn't fill the tank.</i>	Compressor in-line check valve fitting has been overtorqued.	Loosen fitting and check again. Replace if needed.
<i>Display shows UNSUCCESSFUL.</i>	“Double Click” for Preset not completed within 2 second window.	If display is in sleep mode, click once to “Wake Up”, then “Double Click” desired preset within 2 seconds of each press.
	Calibration may need to be adjusted or system may need to be recalibrated.	Adjust ADJ value or recalibrate system to reduce number of iterations.
	Tank pressure settings changed.	Attempt recalibration.
	Vehicle load changed significantly.	
	Air springs/air lines/tank changed.	
<i>Display shows PRESSURE SENSOR FAILURE.</i>	ECU has detected a pressure sensor operating incorrectly.	Only manual mode can be used to operate suspension. Contact customer service immediately to resolve the problem.

Leak Testing and Detection

Leak detection

1. A leak can be defined as a loss of pressure of more than 5 psi over an 8 hour period. Be aware that ambient temperature change has an effect on pressure that may seem like a leak. For example: a change of 10deg Fahrenheit up or down from your baseline will have an approximate gain or loss of indicated pressure of 2 psi. If a leak is suspected after including any temperature change, then proceed to #2.
2. Spray soapy water (1/5 Dawn brand dish soap to 4/5 water) on suspect fittings and hose connections and look for any bubbling caused by air leakage.
3. Fix leaking connection (review pg. 6 for help on NPT fittings and air line connections).
4. Wipe down sprayed connections with rag to remove any residual soapy water.

NOTE

Dawn brand dish soap will not corrode the metals (aluminum, brass, steel) with which it comes into contact.

Electrical Schematic

AUTOPILOT V2 GEN 3 PRESSURE CONTROL

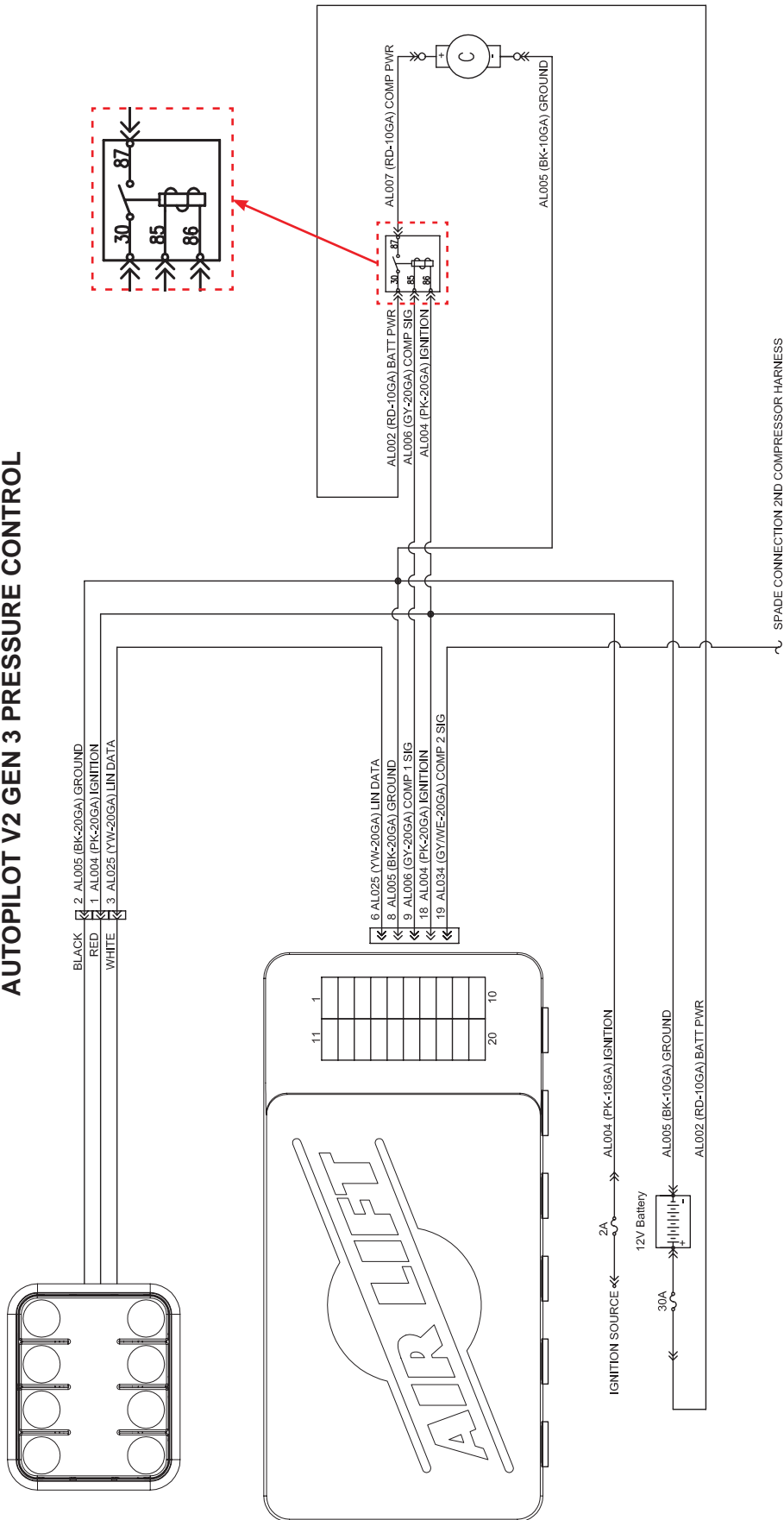

AUTOPILOT V2 SECOND COMPRESSOR HARNESS*

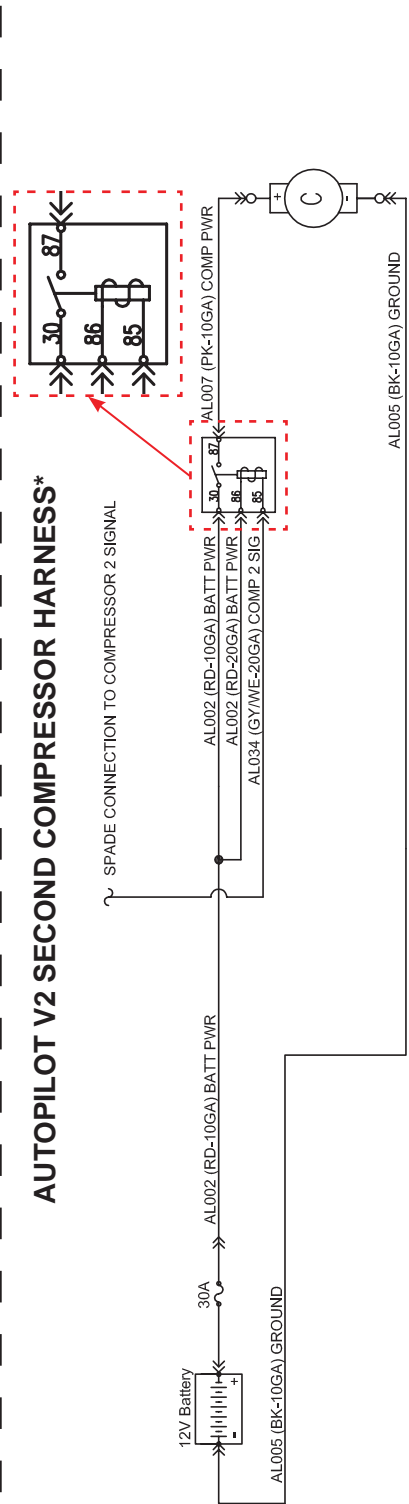

* Sold separately
Air Lift Part Number 27679

fig. 18

AutoPilot V2 Remote Control Unit Dimensions

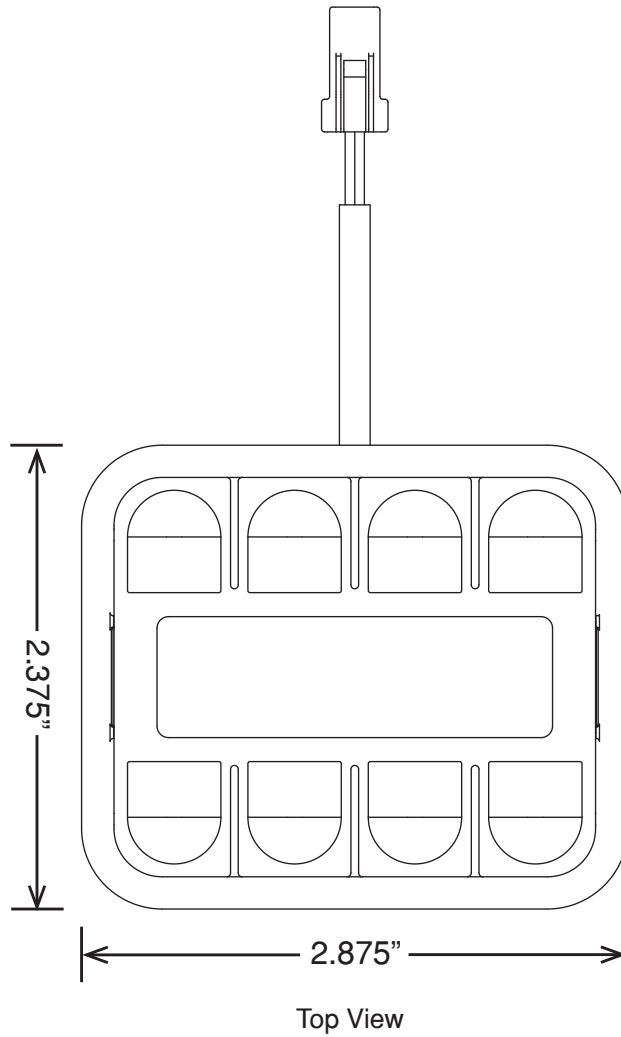

Notes

Manifold Template

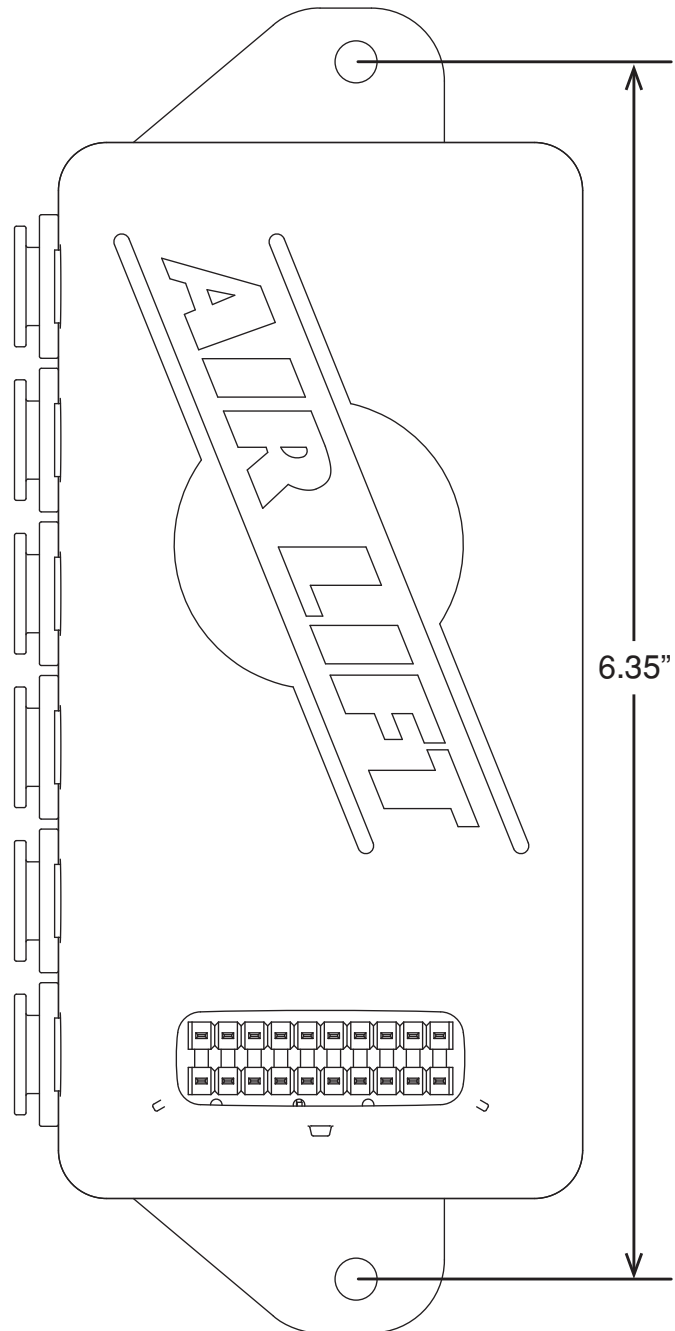

Notes

16380 Compressor Template

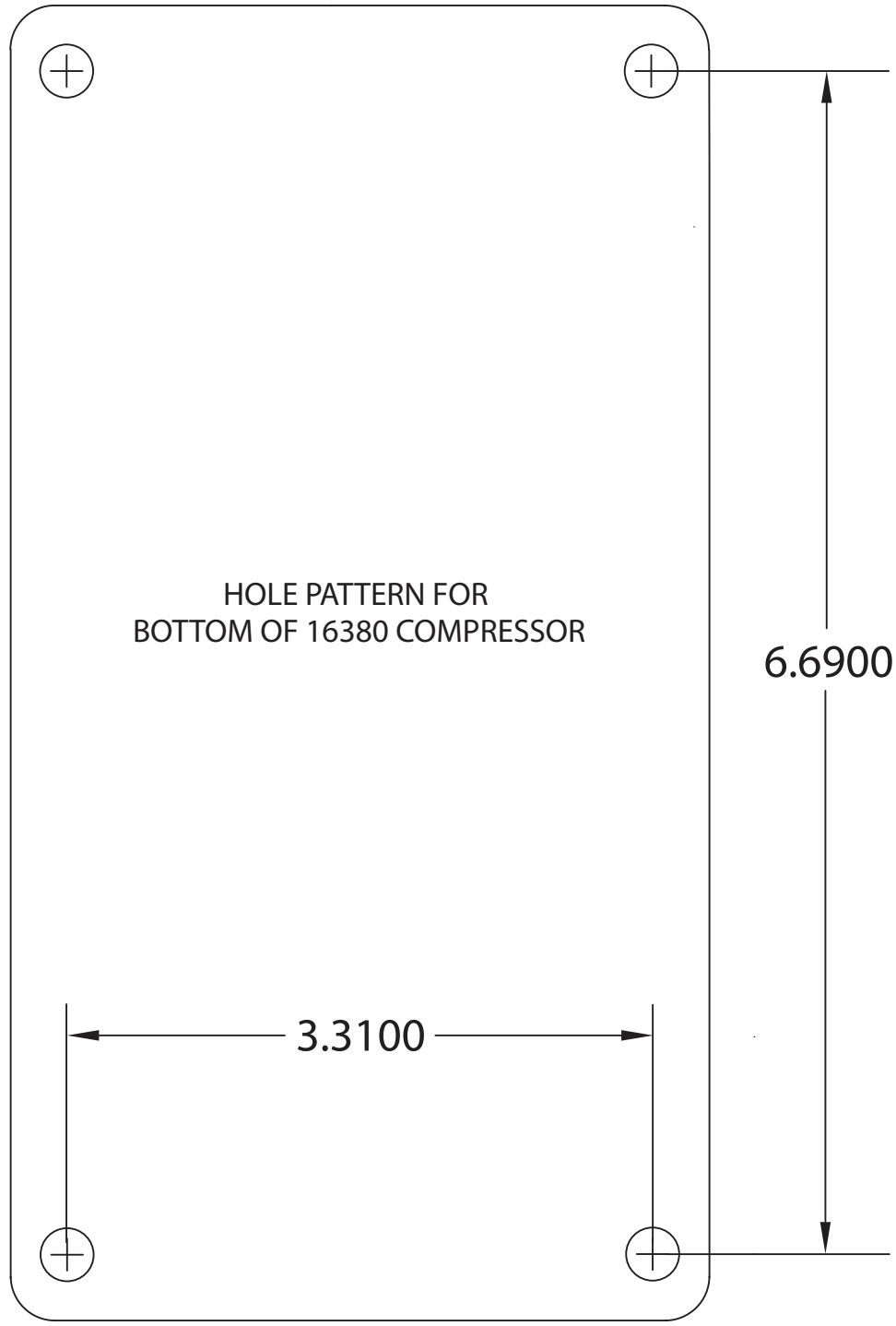

Notes

Warranty and Returns Policy

Air Lift Company warrants its performance products for one year to the original purchaser against manufacturing defects one year from the date of purchase when used on cars and trucks as specified under normal operating conditions. The warranty does not apply to products that have been improperly applied, improperly installed, or which have not been maintained in accordance with installation instructions furnished with all products. The consumer will be responsible for removing (labor charges) the defective product from the vehicle and returning it, transportation costs prepaid, to the dealer from which it was purchased or to Air Lift Company for verification.

Air Lift will repair or replace, at its option, defective products or components. A minimum \$10.00 shipping and handling charge will apply to all warranty claims. Before returning any defective product, you must call Air Lift at (800) 248-0892 in the U.S. and Canada (elsewhere, (517) 322-2144) for a Returned Materials Authorization (RMA) number. Returns to Air Lift can be sent to: Air Lift Company • 2727 Snow Road • Lansing, MI • 48917.

Product failures resulting from abnormal use or misuse are excluded from this warranty. The loss of use of the product, loss of time, inconvenience, commercial loss or consequential damages is not covered. The consumer is responsible for installation/reinstallation (labor charges) of the product. Air Lift Company reserves the right to change the design of any product without assuming any obligation to modify any product previously manufactured.

This warranty gives you specific legal rights and you may also have other rights that may vary from state-to-state. Some states do not allow limitations on how long an implied warranty lasts or allow the exclusion or limitation of incidental or consequential damages. The above limitation or exclusion may not apply to you. There are no warranties, expressed or implied including any implied warranties of merchantability and fitness, which extend beyond this warranty period. There are no warranties that extend beyond the description on the face hereof. Seller disclaims the implied warranty of merchantability. (Dated proof of purchase required.)

Replacement Information

If you need replacement parts, contact the local dealer or call Air Lift customer service at (800) 248-0892. Most parts are immediately available and can be shipped the same day.

Contact Air Lift Company customer service at (800) 248-0892 first if:

- Parts are missing from the kit.
- Need technical assistance on installation or operation.
- Broken or defective parts in the kit.
- Wrong parts in the kit.
- Have a warranty claim or question.

Contact the retailer where the kit was purchased:

- If it is necessary to return or exchange the kit for any reason.
- If there is a problem with shipping if shipped from the retailer.
- If there is a problem with the price.

Contact Information

If you have any questions, comments or need technical assistance contact our customer service department by calling (800) 248-0892, Monday through Friday. For calls from outside the USA or Canada, our local number is (517) 322-2144. You may also contact customer service anytime by e-mail at techsupport@airliftperformance.com.

For inquiries by mail, our address is PO Box 80167, Lansing, MI 48908-0167. Our shipping address for returns is 2727 Snow Road, Lansing, MI 48917.

You may also contact our sales team anytime by e-mail at sales@airliftperformance.com or on the web at www.airliftperformance.com.

Need Help?

Contact our customer service department by calling (800) 248-0892, Monday through Friday. For calls from outside the USA or Canada, our local number is (517) 322-2144.



Thank you for purchasing Air Lift Performance products!

Air Lift Company • 2727 Snow Road • Lansing, MI 48917 or PO Box 80167 • Lansing, MI 48908-0167
Toll Free (800) 248-0892 • Local (517) 322-2144 • Fax (517) 322-0240 • www.airliftperformance.com

Printed in
the USA