

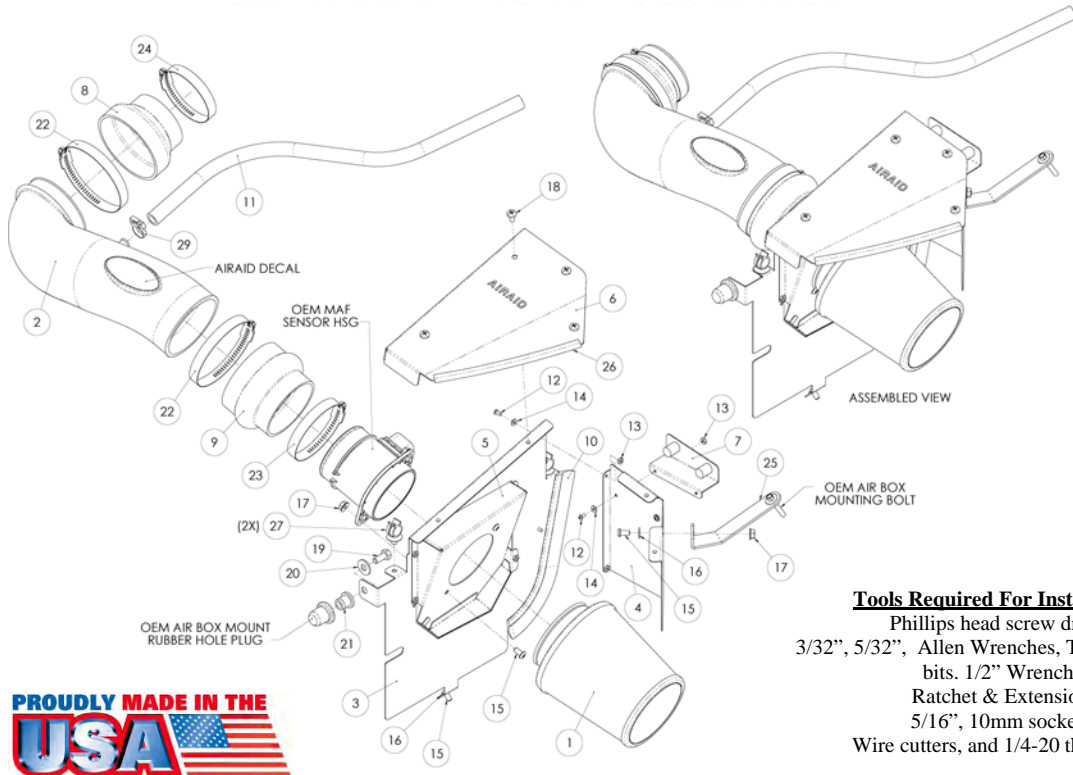

INTAKE SYSTEMS



PROUDLY MADE IN THE USA

Tools Required For Installation:

Phillips head screw driver
3/32", 5/32", Allen Wrenches, T-15, T-20 Torx bits, 1/2" Wrench, Ratchet & Extension, 5/16", 10mm sockets, Wire cutters, and 1/4-20 thread tap

Installation Instructions Part Number 251-252 2008-10 Cadillac CTS 3.6l V6 All models

Packing List:

#1	701-452	Airaid Premium Filter	1
#2	KIT252T	Airaid Intake Tube	1
#3	KIT253MAFFC	MAF Panel	1
#4	KIT253RPC	Rear Panel	1
#5	KIT252APC	Adapter Panel	1
#6	KIT253TOPC	Top Cover	1
#7	KIT253CBC	OEM Cover Bracket	1
#8	KITRDCR15	Silicone Reducer Coupler	1
#9	KITHUMPHS26	Silicone Hump Hose	1
#10	KITWSTRIP02	Weather Strip 9 3/4"	1
#11	KITHOSE01	1/2"x 26"Breather Hose	1
	KIT252HPS	Hardware & Instructions	1
#12	KIT6C31MXPPZ	6-32 x 5/16" Phillips Head Screw	8
#13	KIT6CNKEPZ	6-32 Kep Nut	8
#14	KIT6NWSAPZ	#6 Flat Washer	8
#15	KIT15DHC3050	1/4-20 x 1/2" Button Head Screw	4
#16	KIT09FWZ019	1/4" Flat Washer	2
#17	KIT1420WZZF	1/4-20 Serrated Nut	3
#18	KIT1408MPPBZKC	1/4-20x1/2" Phillips Head Screw	4
#19	KIT31C75HCS5	5/16-18 x 3/4" Hex Bolt	1
#20	KIT25NWUSPZ	5/16" Flat Washer	1
#21	KITNUT03	5/8" Well Nut	1
#22	KITHS64	#64 Hose Clamp	2
#23	KITHS52	#52 Hose Clamp	1
#24	KITHS48	#48 Hose Clamp	1
#25	KIT253B	Bracket	1
#26	KITX1011	Rubber Edge Trim 8"	1
#27	KITFITTING20	5/8" Hose Fir Tree Anchor	2
#28	KITFITTING21	Edge Clip Cable Tie	2
#29	KITSNPM4	Black Speed Clamp	1



1. Disconnect the negative battery cable. Remove the engine and shock tower covers, if so equipped, by simply pulling up on them, and sliding out from the vehicle. These will be reused later in step 16



2. A) Loosen the hose clamps on the factory intake tube. **B)** Disconnect the breather line and remove the factory intake tube. **C)** Disconnect the Mass Air Flow sensor.

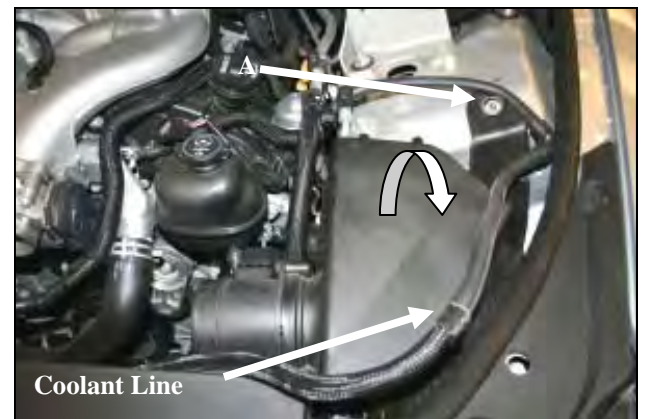

3. A) Remove the factory fender bolt securing the air box assembly. Next pull out the coolant line from atop the air box lid and gently rotate the air box assembly towards the front of the vehicle. The air box assembly is now free and should be removed from vehicle.



4. Use caution not to lose the factory core support grommet while removing the air box assembly. It will be needed in step 13.

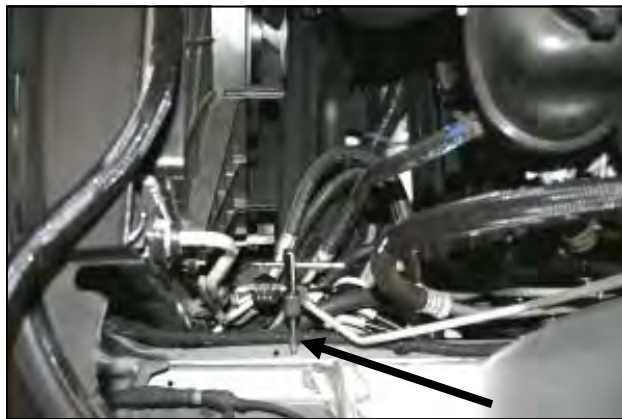

5. Locate the pre existing hole in the chassis and tap it for a 1/4-20 bolt. Use a 1/4-20 NC tap with anti-seize lube or equivalent, and follow the 1/4 turn forward, 1/2 turn back rule. This will ensure that clean threads will be cut into the hardened steel.

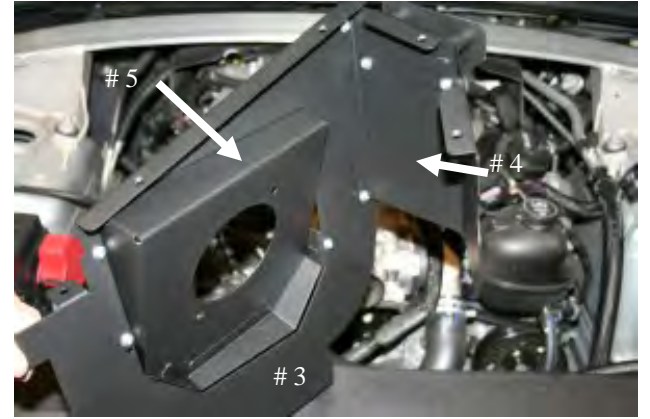

6. Install the Adapter Panel (#5) to the MAF Panel (#3) as shown using four 6-32 screws (#12), 6-32 Kep nuts, and #6 flat washers (#14). Attach the Rear Panel (#4) to the MAF Panel using two 6-32 screws.



7. Attach the OEM Cover Bracket (#7) to the Rear Panel as shown using the remaining two sets of 6-32 hardware

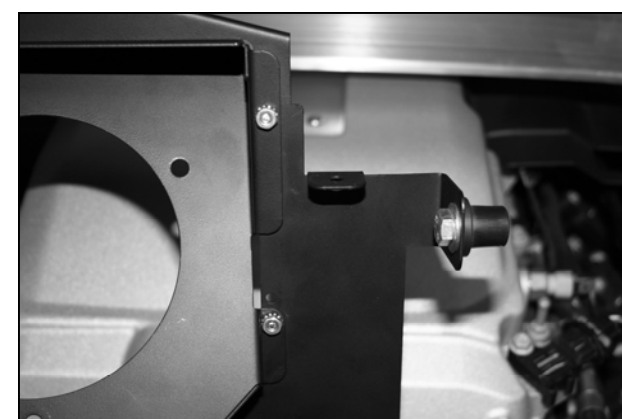

8. Attach the 5/8" Well Nut (#22) to the vertical MAF Panel tab as shown using the 5/16 Hex Bolt (#20) and the 5/16" flat washer (#21).

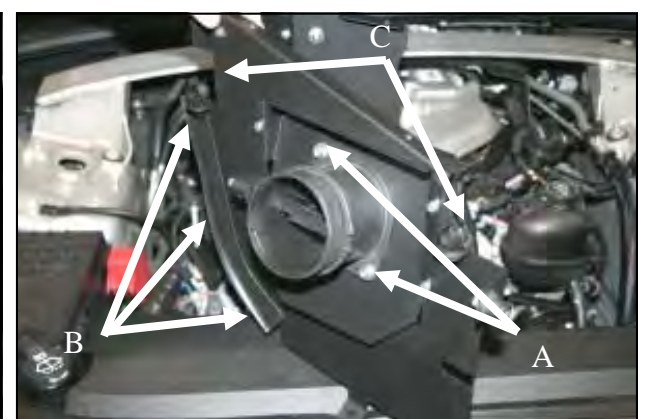

9. A) Transfer the Mass Air Flow Sensor from the factory airbox to the Adapter Panel and secure using two 1/4-20 button Head Screws (#15) and Serrated Nuts (#17). Note: The factory airbox seal on the Mass Air Flow Meter is not to be used in this kit. **B)** Attach the Weather Strip (#11) to the curved edge of the MAF Panel. **C)** Insert the 5/8" hose anchors (#28) into the two horizontal tab holes on the MAF panel.

Refer to the Exploded View Drawing for additional information on part locations and orientations.



11. Install the Reducer Coupler (#8) onto the 90 deg. Bend of the Airaid Intake Tube (#2) and place the Hump Hose on the opposite end as shown. Secure the couplers to the Intake Tube using the two #64 clamps (#22). Place the #48 clamp (#24) on the reducing coupler and the remaining #52 clamp (#23) on the Hump Hose.

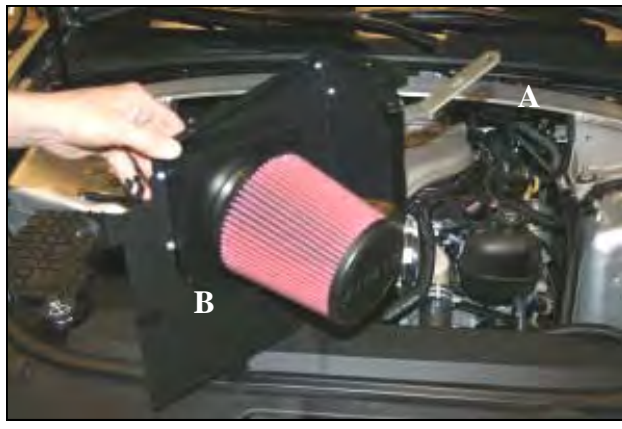

12. **A)** Install the Bracket (#25) on to the Rear Panel (#4) as shown using one 1/4-20 Button Head Screw (#15), 1/4" Flat Washer (#16), and 1/4" Serrated Nut (#17). **B)** Complete the assembly by attaching the Airaid Premium Filter (#1) Mass Air Flow Sensor.

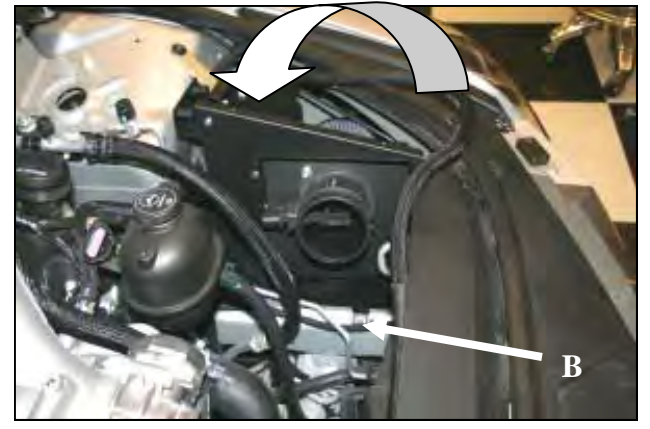

13. **A)** Lower the Airaid Performance Air box assembly into the engine cavity. Insert the Well Nut into the Factory core support grommet and rotate the assembly rearward until the bracket rests on the shock tower and the MAF panel's lower tab hole is lined up with the Tapped Chassis bolt hole. **B)** Secure the assembly by using the 1/4-20x 1/2 Bolt (#15).



14. **A)** Install the Airaid Intake Tube assembly onto the Mass Air Flow Sensor first, and then onto the throttle body. Adjust for fit, and tighten the hose clamps. **B)** Replace the factory breather line on the valve cover with the 26" Airaid Breather Hose (#11). Secure the breather hose to the intake tube nipple using the black Speed Clamp (#29)

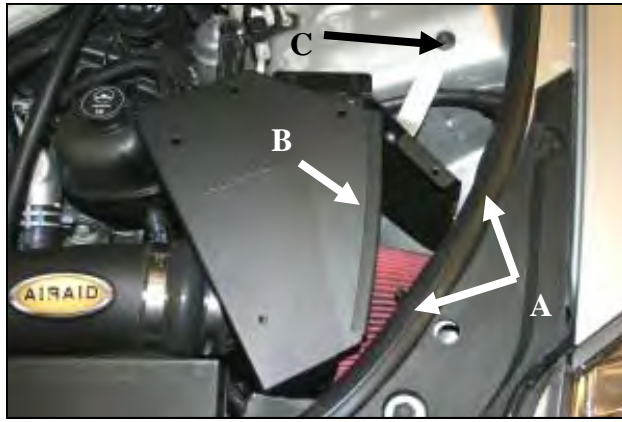

15. **A)** Slide the Edge Clip Cable Ties (#30) about 6" apart along the fender pinch weld and return the coolant line to its original location. Secure the coolant line using the cable ties and trim off excess. **B)** Install the 8" Weather Strip (#26) onto the curved edge of the top cover (#6) and install the top cover onto the Airaid filter box using the four 1/4-20 Black screws (#21). **C)** Line up the intake bracket with the fender bolt hole, and secure the assembly using the factory bolt. **Note: These steps must be performed in order to avoid difficulty with bolt hole alignment.**



16. Reinstall the Factory engine and shock tower covers. **Reconnect the negative battery cable. Double check your work!** Make sure there is no foreign material in the intake path. Make sure all clamps, hoses, bolts, and screws are tight. Double check the hood clearance.

Before!



After!



Synthamax Air Filters do not require oil. Service air filter as needed by cleaning with common non-petroleum all-purpose household cleaner and water. Simple Green®, Formula 409® or equivalent works great. Apply cleaner to outside of air filter and allow to soak. Then flush filter clean from the inside out with a garden hose and repeat steps if necessary. Do not apply high pressure water or air to clean filter. Allow filter to air dry and reinstall.

Synthamax

Do Not Oil



Thank you for purchasing the Airaid Intake System. Contact Airaid @ (800) 498-6951 8:00 AM - 5:00 PM MST weekdays for questions regarding fit or instructions that are not clear to you. Your Airaid Intake System was carefully inspected and packaged. Check that no parts are missing, or were damaged during shipping. If any parts are missing, contact Airaid. The air filter element is protected from direct exposure to water and debris; care should be taken not to drive through deep water. WATER INGESTION IS THE DRIVERS RESPONSIBILITY