

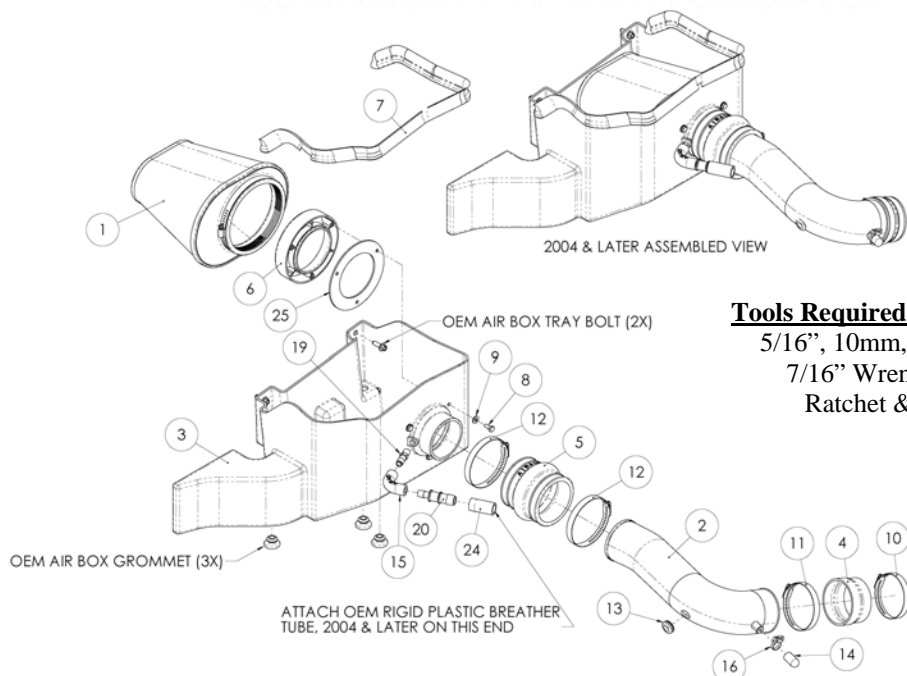

INTAKE SYSTEMS



Tools Required For Installation:

5/16", 10mm, 13mm Sockets
7/16" Wrench or Socket
Ratchet & Extension

Installation Instructions

Part Number 300-220

2003-08 Dodge Ram 1500 Thru 3500

5.7L V-8

Packing List:

#1	720-476	Airaid Premium Filter	1
#2	KIT924T	Airaid Intake Tube	1
#3	KIT220CAB	Cool Air Box	1
#4	KITRDCR04	Reducing Coupler	1
#5	KITHUMPHS02	Urethane Hump Hose	1
#6	KIT214FADA	Filter Adapter	1
#7	KITWSTRIP03	Weather Strip 33"	1
	KIT220HP	Hardware & Instructions	1
#8	KIT25C62HCSS	1/4-20 X 5/8" Hex Bolt	3
#9	KIT09FWZ019	1/4" Flat Washer	3
#10	KITHS52	#52 Hose Clamp	1
#11	KITHS56	#56 Hose Clamp	1
#12	KITHS60	#60 Hose Clamp	2
#13	KITGRMT02	Grommet	1
#14	KIT106CAP	Rubber Cap	1
#15	KITELBOW04	1/2" x 90° Elbow	1
#16	KITSNP14M4	#14 Speed Clamp	1
#17	KITSNP16M4	#16 Speed Clamp	2
#18	KITSNP22M4	#22 Speed Clamp	2
#19	KITFITTING09	1/4"NPT x 1/2" Barbed Fitting	1
#20	KITFITTING18	1/2" x 3/4" Barbed Connector	1
#21	KITFITTING03	1/2" x 5/8" Barbed Connector	1
#22	KITFITTING04	1/4"NPT Hex Plug	1
#23	KITHOSE01	1/2" x 4 1/2" Breather Hose	1
#24	KITHOSE05	3/4" x 2" Breather Hose	1
#25	KIT214G	Adapter Gasket	1



1. Disconnect the negative battery cable!

Loosen the hose clamp on the flexible intake tube at the airbox lid. Disconnect the breather hose going into the factory airbox lid. Slide the flexible tube off of the lid and lift the airbox assembly straight up and out of the vehicle. **2003 Models:** Disconnect the breather hose from the back of the resonator.



2. Squeeze the tab on the connector and disconnect the intake temperature sensor wiring harness on the front of the resonator. Next remove the two bolts that secure the resonator to the engine. Lift the resonator up at the front, and remove it from the vehicle.



3. Remove the factory seal from the throttle body.



4. Using a 13mm socket, remove two bolts holding the airbox mounting bracket to the inner fender. These bolts will be reused in step #9.



5. Gently twist the air temperature sensor counter-clockwise and remove it from the resonator. The sensor will be reinstalled in step #11.

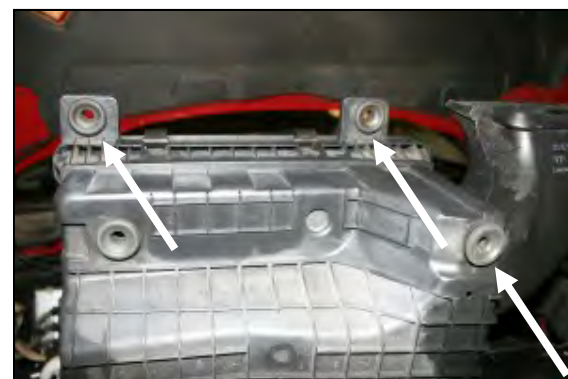

6. Remove and save three grommets from the bottom of the factory airbox. They will be reused in step #7.

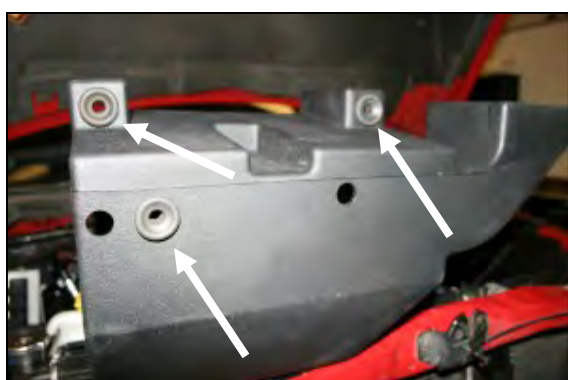

7. Install the three grommets removed in step # 6 into the bottom of the Airaid Cool Air Dam (CAD)(#3) at the locations shown here.

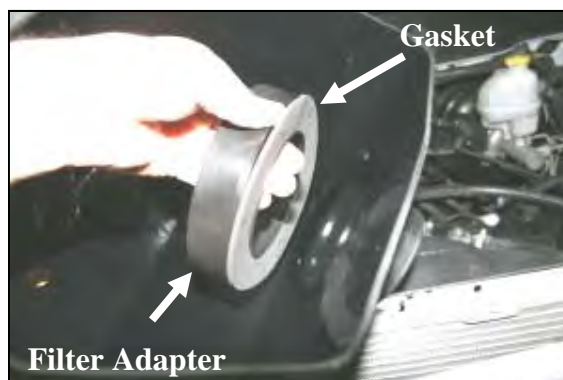

8. Install the adapter gasket (#25) and filter adapter (#6) into the CAD using three 1/4-20 x 5/8" bolts (#8) and flat washers (#9) as shown. Refer to the line drawing above for reference.



9. Install the CAD into the vehicle by aligning the grommets over the locating pins on the factory airbox mount. Reinstall the factory bolts in the fender that were removed in step #4. Next install the 1/4"NPT x 1/2" barbed fitting (#19) into the CAD.

2003 Models: Install the 1/4"NPT plug (#22) in place of the barbed fitting.



10. Install the supplied reducing coupler (#4), onto the throttle body using one #52 hose clamp (#10) on the throttlebody and one #56 hose clamp (#11) on the open end. Install the hump hose (#5) with two #60 hose clamps (#12) onto the CAD.



11. Install the supplied grommet (#13) into the Airaid intake tube(#2). Next, *carefully* install the factory air intake temperature sensor into the grommet in the tube. Make sure it is fully seated into the grommet.



12. Install the Airaid intake tube into the hump hose first, and then into the reducing coupler. Adjust for fit, and then tighten all four hose clamps.
2004-08 Models: Reconnect the breather by sliding the 3/4" x 2" hose (#24) over the factory breather tube. Next insert the 1/2" to 3/4" barbed connector (#20) into the 3/4" hose. Now connect the 1/2" rubber elbow (#15) between the 1/2" barbed fitting on the CAD and the previous fitting. Now slide the rubber cap (#14) over the nipple on the Airaid intake tube and secure it with the #14 speed clamp (#16).



13. 2003 Models: Reconnect the factory breather hose using the 1/2" x 5/8" connector (#21) and 1/2" x 4 1/2" breather hose. Secure the ends with the #16 speed clamps (#17), and the #22 speed clamps (#18) as shown.



14. Install the Airaid Premium Filter (#1) onto the tube on the filter adapter and tighten the clamp. Next install the weather strip (#7) on the top of the Quick Fit Panel as shown. (*Hint: Start at one end of the CAD and work your way towards the other end.*)

16. Double check your work!

Make sure there is no foreign material in the intake path. Make sure all clamps, hoses, fasteners, and wiring connections are tight.

17. Reconnect the negative battery cable!

Thank you for purchasing the Airaid Intake System. Contact Airaid @ (800) 498-6951 8:00 AM - 5:00 PM MST weekdays for questions regarding fit or instructions that are not clear to you. Your Airaid Intake System was carefully inspected and packaged. Check that no parts are missing, or were damaged during shipping. If any parts are missing, contact Airaid. The air filter element is protected from direct exposure to water and debris; care should be taken not to drive through deep water. WATER INGESTION IS THE DRIVERS RESPONSIBILITY! The air filter is reusable and should be cleaned using the Airaid Filter Tune-Up Kit periodically.

Before!



After!



Don't Forget Your AIRAID Filter Tune-Up Kit!



P/N 790-551 Aerosol Spray
P/N 790-550 Squeeze Spray



Instructions Revision
Date: 10/15/08