



Installation Instructions

For Part Numbers :

- 300-283 720-476 Airaid Oiled Media Filter
- 301-283 721-476 SynthaMax Dry Media Filter - Red
- 302-283 722-476 SynthaMax Dry Media Filter - Black
- 303-283 723-476 SynthaMax Dry Media Filter - Blue

2013-2015 Ram 1500 3.6L V6

Component Identification

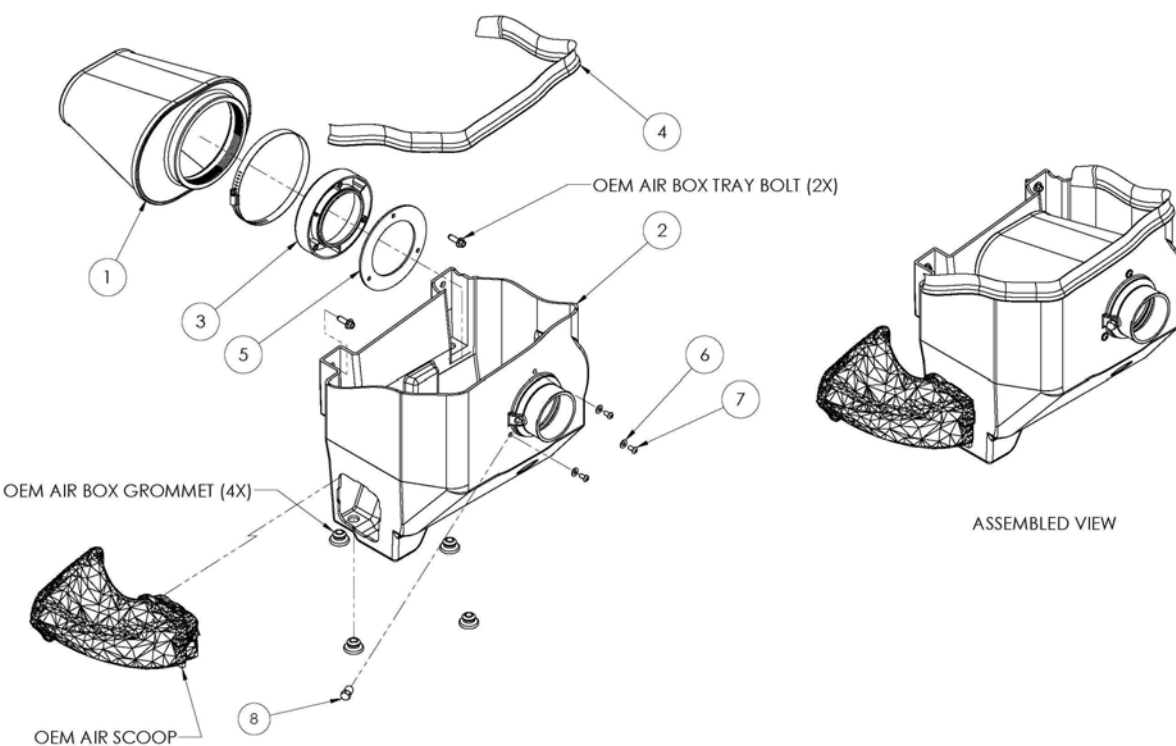

1.	Airaid Premium Filter	1
2.	Cool Air Box	1
3.	Filter Adapter	1
4.	Weather Strip 32.5"	1
5.	Adapter Gasket	1
6.	1/4" Flat Washer	3
7.	1/4-20 x 1/2" Button Head Screw	3
8.	1/4" NPT Plug	1

Full color instructions can be viewed on our web site at Airaid.com. Use the **Product Search** function to find your part number, and click **View Details**.



1. Disconnect The Negative Battery Terminal!
Loosen one hose clamp at each end of the air intake tube and remove it from the vehicle.

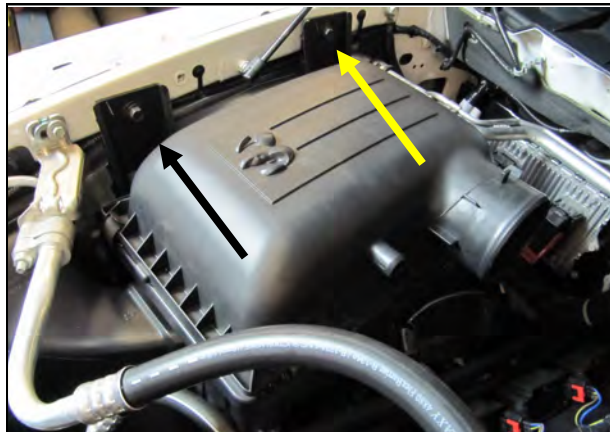

2. Remove the two fender bolts in the air box cradle.
The bolts will be reused in step #10



3. Rock the air box back and forth as you are lifting it straight up to remove it from the vehicle. It is only held in by grommets.

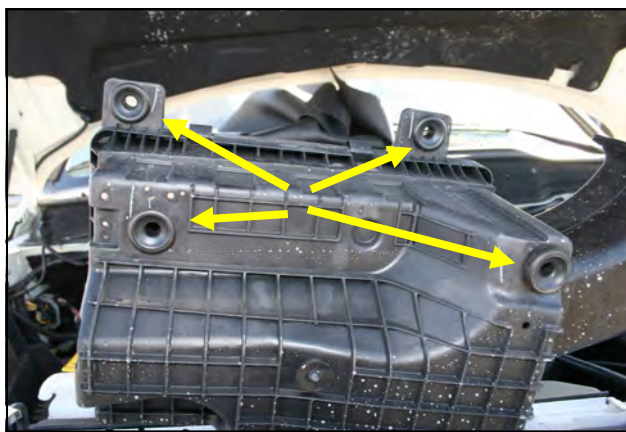

4. Remove and save four grommets from the bottom of the factory air box. They will be reused in step #5

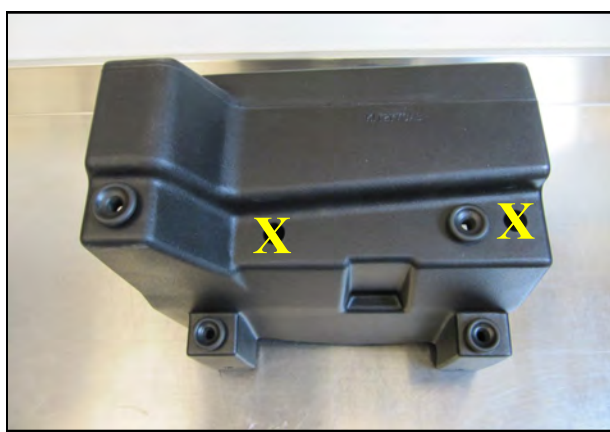

5. Transfer the 4 factory air box grommets into the Airaid Cool Air Box as shown. Note: Two of the holes do not receive grommets.

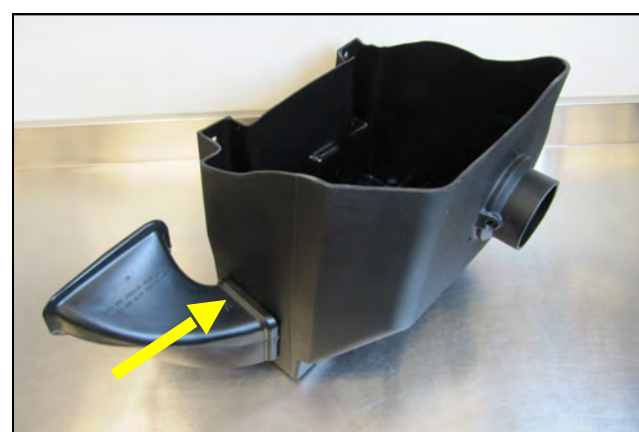

6. Transfer the scoop from the factory air box into the Airaid Cool Air Box as shown.

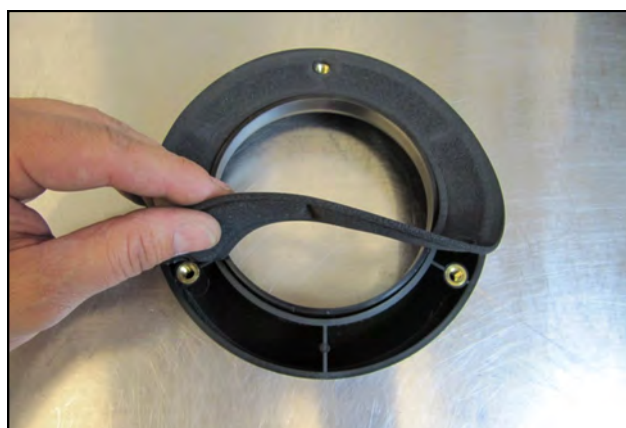

7. Prepare the Filter Adapter (#3) for installation by mating it to the Adaptor Gasket (#5) and aligning the bolt holes.



8. Mount the Filter Adapter and Gasket inside the Cool Air Box as shown using the three sets of 1/4-20 Button Head Screws (#7) and 1/4" Flat Washers (#6).

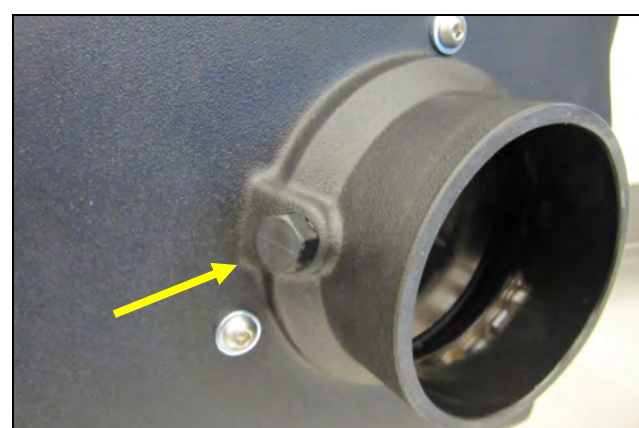

9. Install the 1/4" Plug (#8) into the Cool Air Box snout as shown.

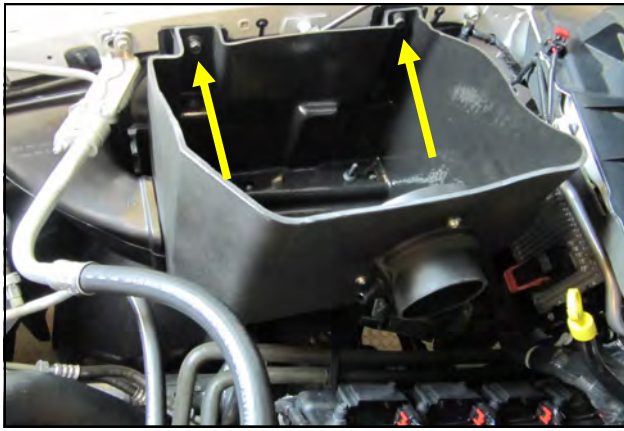

10. Set the Airaid Cool Air Box into the cradle and secure it using the factory hardware removed in step #2.

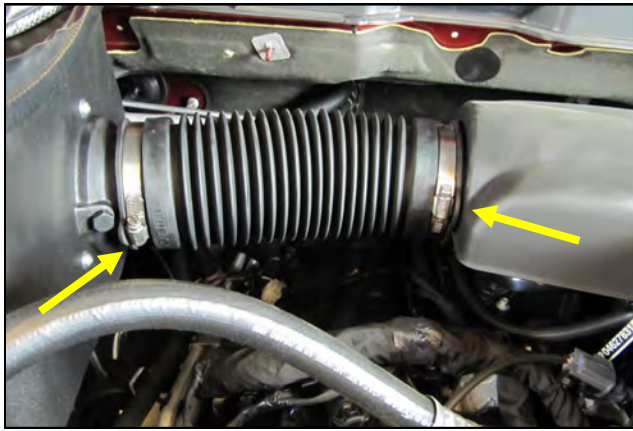

11. Reinstall the factory air intake tube and tighten the two hose clamps.



12. Install the Airaid Premium Filter onto the Filter Adapter inside the Cool Air Box. Install the Weatherstrip onto the Cool Air Box as shown, with the contour rolling away from the Filter.

13. Double check your work!

Make sure there is no foreign material in the intake path. Make sure all clamps, hoses, bolts, and screws are tight. Double check the hood clearance!

Reconnect the negative battery cable!

Thank you for purchasing the Airaid Intake System. Contact Airaid @ (800) 498-6951 8:00 AM - 5:00 PM MST weekdays for questions regarding fit or instructions that are not clear to you. Your Airaid Intake System was carefully inspected and packaged. Check that no parts are missing, or were damaged during shipping. If any parts are missing, contact Airaid. The air filter element is protected from direct exposure to water and debris; care should be taken not to drive through deep water. WATER INGESTION IS THE DRIVERS RESPONSIBILITY! The air filter is reusable and should be cleaned periodically.

FILTER IDENTIFICATION

720-476 Airaid Oiled Media
722-476 Airaid SynthaMax Dry Media - Black

721-476 Airaid SynthaMax Dry Media - Red
723-476 Airaid SynthaMax Dry Media - Blue

For your Oiled media filter we suggest using the AIRAID Filter Tune-Up Kit!



P/N 790-551 Aerosol Spray
P/N 790-550 Squeeze Spray



SynthaMax[®]

Do Not Oil

Synthamax Air Filters do not require oil. Service air filter as needed by cleaning with common non-petroleum all-purpose household cleaner and water. Simple Green[®], Formula 409[®] or equivalent works great. Apply cleaner to outside of air filter and allow to soak. Then flush filter clean from the inside out with a garden hose and repeat steps if necessary. Do not apply high pressure water or air to clean filter. Allow filter to air dry and reinstall.