

# AIRRAID®

## INTAKE SYSTEMS

**Installation Instructions**  
**Part Number 311-200**  
**2006-10 Jeep Commander 5.7L Hemi**

### Packing List:

#1	701-458	Airaid Premium Filter	1
#2	KIT200MAFC	MAF Panel	1
#3	KIT170FPC	Front Panel	1
#4	KIT170T	Airaid Intake Tube	1
#5	KITHUMPHS01	3 1/2"x4 1/2" Hump Hose	1
#6	KITRDCR04	3 1/2" to 3 3/8" Reducer	1
#7	KITWSTRIP02	Weather Strip 17 1/2"	1
	KIT200HPS	Hardware & Instructions	1
#8	KITGRMT03	Grommet	1
#9	KITHS56	#56 Hose Clamp	2
#10	KITHS60	#56 Hose Clamp	2
#11	KITSNP16M4	Speed Clamp	1
#12	KIT6C31MXPZ	6-32x5/16" Screw	4
#13	KIT6NWSAPZ	#6 Flat Washer	4
#14	KIT6CNKEPZ	6-32 Keps Nut	4
#15	KIT110T	Nylon Zip Tie	1

### Tools Required For Installation:

5/16" Socket & 10mm Socket  
 Ratchet & Extension  
 Phillips Screwdriver

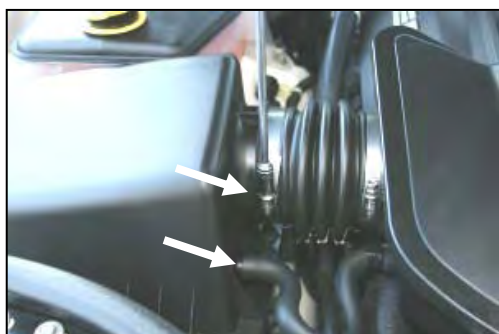
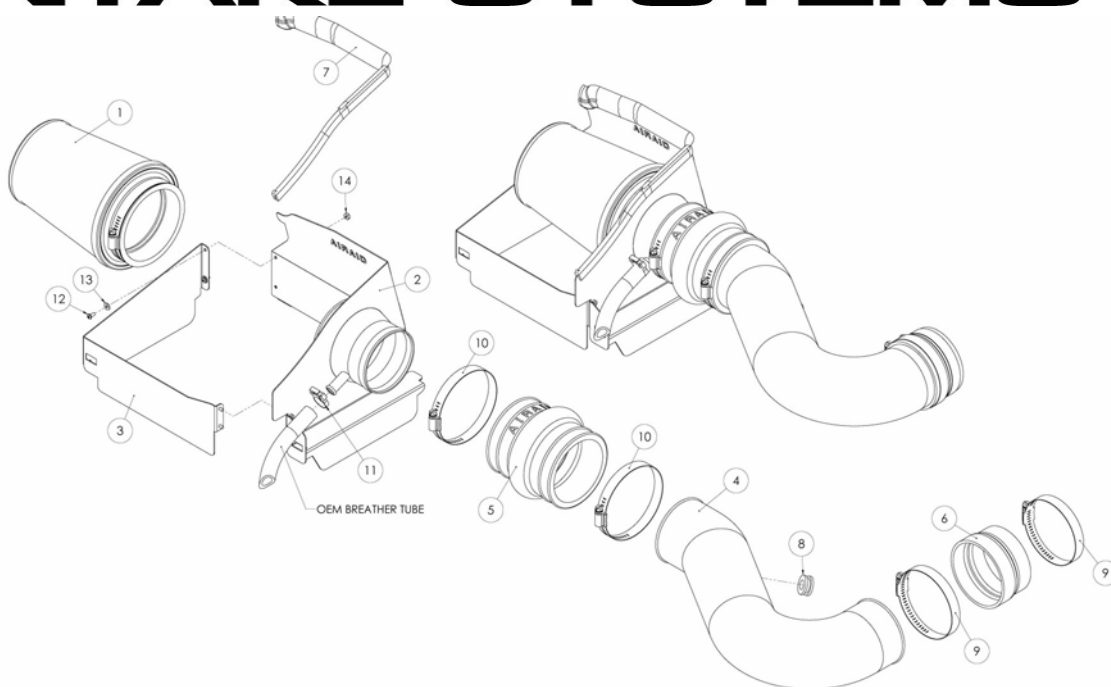

1. **Disconnect the negative battery cable.**  
 Loosen the hose clamp on air cleaner box lid.  
 Twist and remove the breather hose from the air cleaner box lid.

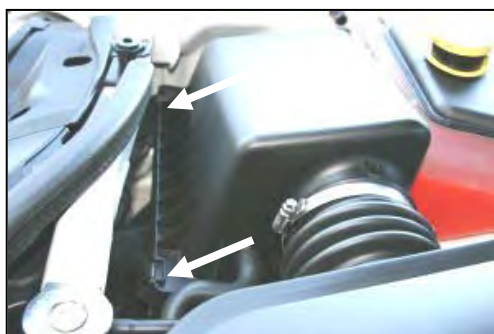

2. Unhook the two air cleaner lid latches on the front of the airbox.

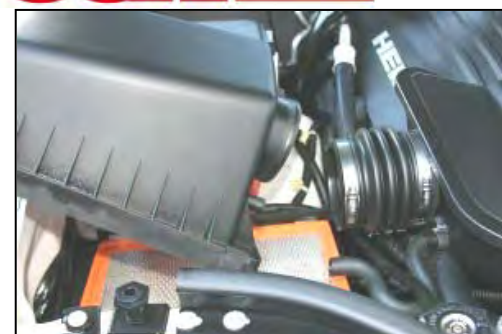

3. Remove the air cleaner box lid by sliding it forward, and then up, and out of the factory intake tube.



4. Remove factory air filter from the air cleaner box.



5. Remove, and set aside the oil filler cap.  
*Use caution not to drop anything into the engine while the cap is off.*



6. Carefully lift up on the engine cover (*it is held in place by grommets, no bolts*) to access the hose clamp on the throttle body, and 10mm bolt next to the throttle body.

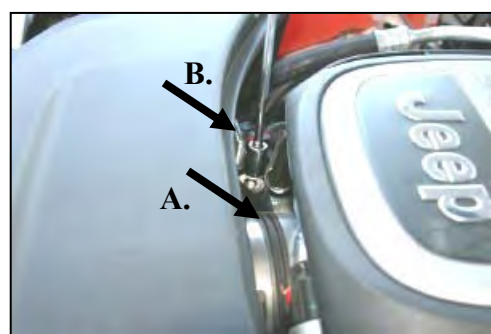

7. A.) Loosen the hose clamp on the throttle body. B.) With a 10mm socket, remove the bolt next to the throttle body that holds the intake resonator in place.



8. Carefully pull the resonator towards you and rotate the bottom up to gain access to the tie wrap holding the breather hose to the rubber coupler. Cut the tie wrap and discard.



9. Slide the clip off of the resonator that holds the breather tube in place.



10. Carefully twist and remove the temperature sensor from the bottom of the resonator, and then remove the resonator from the vehicle.



11. Assemble the two pieces of the Quick Fit panels as shown (#2&#3), using the four 6-32 screws (#12), washers (#13), and nuts (#14), that are provided in the kit.



12. Install the weather strip (#7) on the top of the Quick Fit assembly. (*Hint: start at one end, and go towards the other end, don't start in the middle.*)

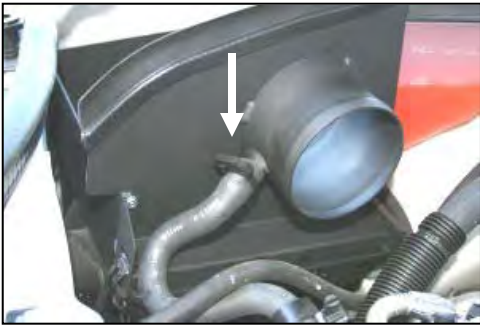

13. Install the Quick Fit assembly in the bottom of the stock air box by sliding the four tabs on the back into the slots on the airbox, once installed, re-hook the two latches. Next, install the speed clamp (#10) over the breather hose and connect it to the Quick Fit assembly as shown.



14. Install the hump hose (#5) and two #60 hose clamps (#10) on the Quick Fit assembly. **Do not tighten** the clamps at this time.



15. Install the reducer (#6) and two #56 hose clamps (#9) on the throttle body as shown. **Do not tighten** the clamps at this time. Secure the breather hose to the air conditioner line using the supplied zip tie (#15).



16. Install the supplied grommet (#8) into the hole in the back of the tube.



17. Carefully install the factory temperature sensor into the grommet. Make sure it is seated all the way in.

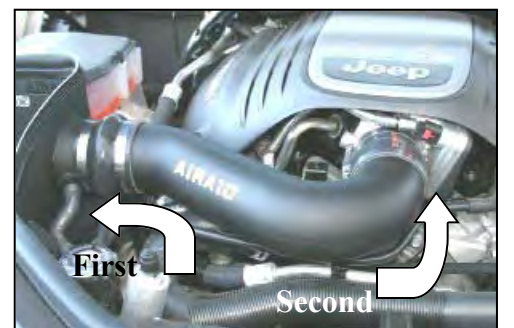

18. Carefully install the end of the Airaid Intake Tube (#4) into the hump hose, and then into the reducer on the throttle body as shown. Adjust the tube as needed, and then **tighten the four hose clamps**.



19. Install the Airaid Premium Filter (#1) on the Quick Fit assembly as shown, and tighten the hose clamp.



20. Re-align the engine cover with the grommets on the engine, and push down firmly to re-seat the cover.



21. Re-install the oil fill plug.

## 22. Double check your work!

Make sure there is no foreign material in the intake path. Make sure all clamps, hoses, bolts, and screws are tight.

## 23. Reconnect the negative battery cable!

Thank you for purchasing the Airaid Intake System. Contact Airaid @ (800) 498-6951 8:00 AM - 5:00 PM MST weekdays for questions regarding fit or instructions that are not clear to you. Your Airaid Intake System was carefully inspected and packaged. Check that no parts are missing, or were damaged during shipping. If any parts are missing, contact Airaid. The air filter element is protected from direct exposure to water and debris; care should be taken not to drive through deep water. **WATER INGESTION IS THE DRIVERS RESPONSIBILITY!**

*Before!*



*After!*



*SynthaMax*

**Do Not Oil**



Synthamax Air Filters do not require oil. Service air filter as needed by cleaning with common non-petroleum all-purpose household cleaner and water. Simple Green®, Formula 409® or equivalent works great. Apply cleaner to outside of air filter and allow to soak. Then flush filter clean from the inside out with a garden hose and repeat steps if necessary. Do not apply high pressure water or air to clean filter. Allow filter to air dry and reinstall.