



Installation Instructions

For Part Numbers:

- 350-319 720-127 Airaid Oiled Media Filter
- 351-319 721-127 SynthaMax Dry Media Filter - Red
- 352-319 722-127 SynthaMax Dry Media Filter - Black
- 353-319 723-127 SynthaMax Dry Media Filter - Blue

2011-15 Dodge Challenger

2011-15 Dodge Charger

2011-14 Chrysler 300

6.4L V8

Component Identification

1.	Airaid Premium Filter	1
2.	Airaid Intake Tube	1
3.	Cool Air Box	1
4.	Filter Adapter	1
5.	Weatherstrip	1
6.	1/4"-20 Button Head Screw	3
7.	1/4" Flat Washer	3
8.	5/16" Flat Washer	1
9.	3/8"-Button Head Screw	1
10.	3/8"-Well Nut	1
11.	#18 Speed Clamp	1
12.	#24 Speed Clamp	2
13.	3/4" Barbed Elbow	1
14.	#56 Hose Clamp	1
15.	#72 Hose Clamp	1

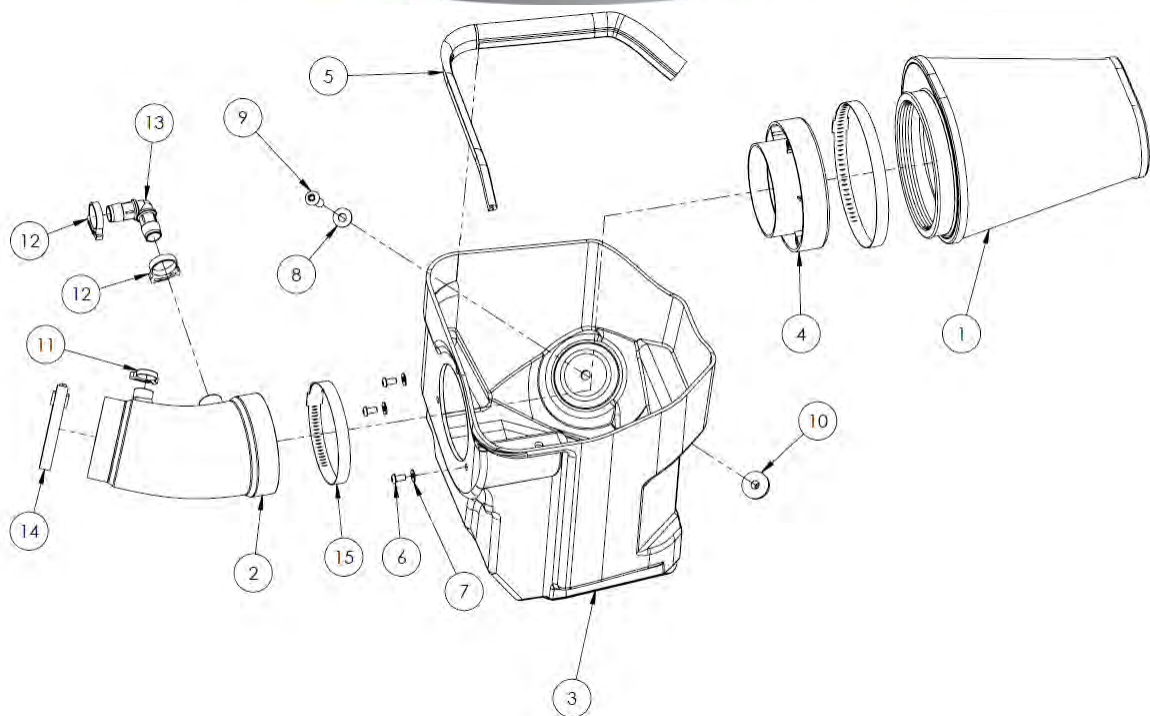

Full color instructions can be viewed on our web site at Airaid.com. Use the **Product Search** function to find your part number, and click **View Details**.



1. Disconnect the negative battery terminal, located in the trunk, by the spare tire.



2. Disconnect the air temperature sensor. Loosen the throttle body clamp on the factory intake tube.

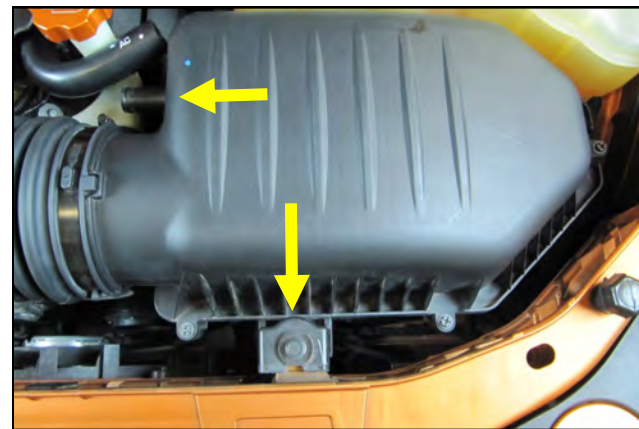

3. Separate the crankcase breather from the air box lid and remove the air box screw in the core support. Lift the air box / tube assembly out of the vehicle and set the screw aside, it will be reused in step 6.

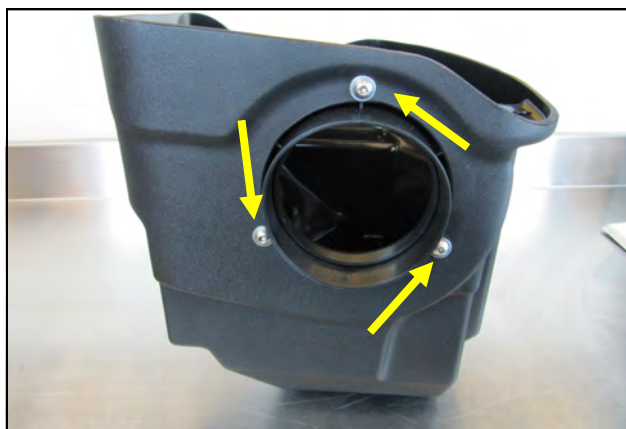

4. Install the Filter Adapter onto the Cool Air Box using the three 1/4" Button Head Screws and 1/4" Flat Washers.

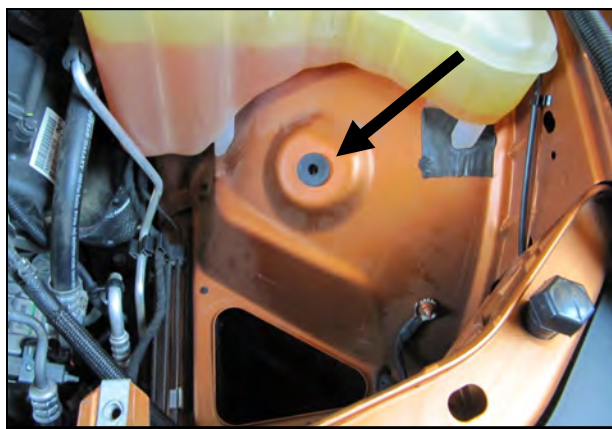

5. Set the Well Nut into the hole in the inner fender.

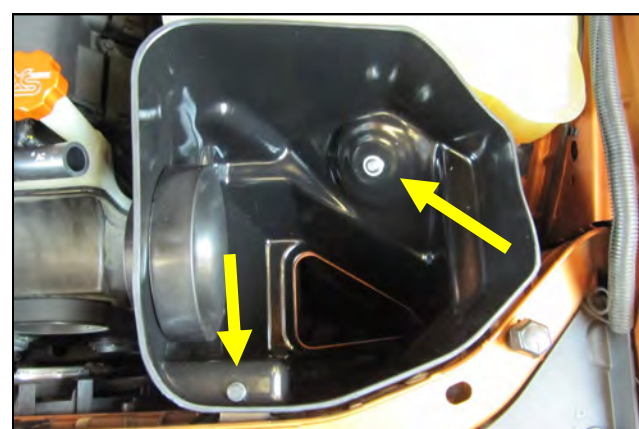

6. Lower the Air Box assembly down into the inner fender. Align the bolt holes and secure the Air Box using the screw removed in step 3 and the 3/8" Button Head Screw with the 5/16" Flat Washer.



7. Insert the Barbed Elbow Connector into the Airaid Intake Tube as shown.



8. Transfer the air temperature sensor from the factory intake tube into the Airaid Intake Tube.

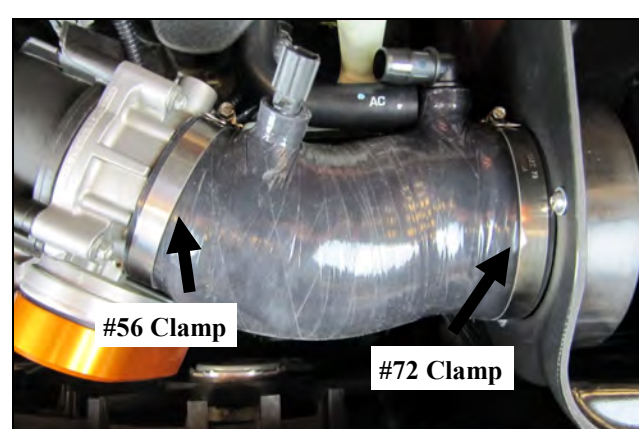

9. Place the #56 and #72 Hose Clamps onto the Airaid Intake Tube and install the assembly leaving the hose clamps loose for now.

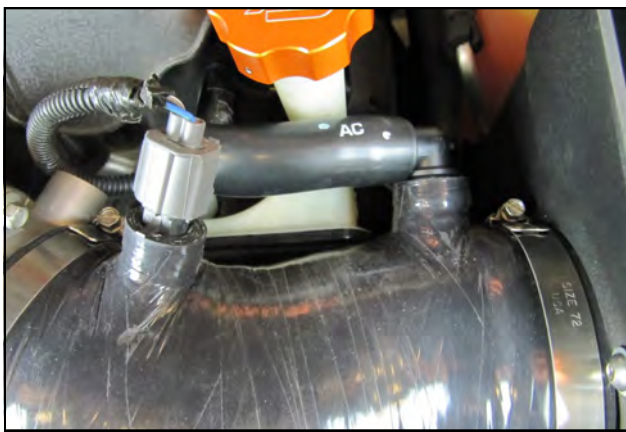

10. Reconnect the air temperature sensor, and the crankcase breather tube to the Barbed Elbow .

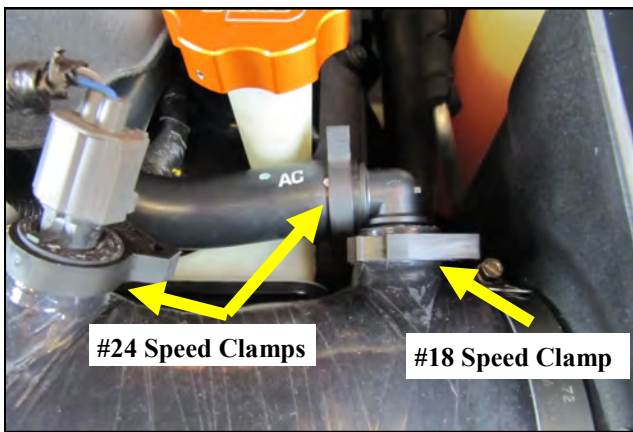

11. Secure the crankcase breather tube and air temperature sensor using two #24 Speed Clamps. Secure the Barbed Elbow using the #18 Speed Clamp. Tighten the Intake Tube Hose Clamps at this time.



12. Install the Airaid Premium Filter onto the Filter Adapter.



13. Install the Weatherstrip onto the top edge of the Air Box with the contour rolling away from the Filter. Re-connect the negative terminal on the battery.

14. Double check your work.

Make sure there is no foreign material in the intake path. Make sure all clamps, hoses, bolts, and screws are tight. Double check the hood clearance!

Thank you for purchasing the Airaid Intake System. Contact Airaid @ (800) 498-6951 8:00 AM - 5:00 PM MST weekdays for questions regarding fit or instructions that are not clear to you. Your Airaid Intake System was carefully inspected and packaged. Check that no parts are missing, or were damaged during shipping. If any parts are missing, contact Airaid. The air filter element is protected from direct exposure to water and debris; care should be taken not to drive through deep water. WATER INGESTION IS THE DRIVERS RESPONSIBILITY! The air filter is reusable and should be cleaned periodically.

FILTER IDENTIFICATION

720-127 Airaid Oiled Media
722-127 Airaid SynthaMax Dry Media - Black

721-127 Airaid SynthaMax Dry Media - Red
723-127 Airaid SynthaMax Dry Media - Blue

**For your Oiled media filter
we suggest using the AIRAID
Filter Tune-Up Kit!**



P/N 790-551 Aerosol Spray
P/N 790-550 Squeeze Spray



SynthaMax

Do Not Oil

Synthamax Air Filters do not require oil. Service air filter as needed by cleaning with common non-petroleum all-purpose household cleaner and water. Simple Green®, Formula 409® or equivalent works great. Apply cleaner to outside of air filter and allow to soak. Then flush filter clean from the inside out with a garden hose and repeat steps if necessary. Do not apply high pressure water or air to clean filter. Allow filter to air dry and reinstall.