

# AIR AID®

## INTAKE SYSTEMS

### Installation Instructions

Part Number 351-171

2005-07 Dodge Magnum 2.7L & 3.5L

2006-07 Dodge Charger 2.7L & 3.5L

2005-07 Chrysler 300C 2.7L & 3.5L

### Packing List:

#1	701-452	Airaid Premium Filter	1
#2	KIT1711MAF	MAF Panel	1
#3	KIT1711FPC	Front Panel	1
#4	KITHOSE01	1/2" x 14" Breather Hose	1
#5	KITWSTRIP02	Weather Strip 27"	1
	KIT1711HP	Hardware Pack	1
#6	KIT6C31MXPPZ	6-32x5/16" Screw	4
#7	KIT6NWSAPZ	#6 Flat Washer	4
#8	KIT6CNKEPZ	6-32 Keps Nut	4
#9	KITELBOW 4	1/2" Rubber Elbow	1
#10	KITSNP18M4	#18 Speed Clamp	3
#11	KITSNP16M4	#16 Speed Clamp	3
#12	KITFITTING08	1/2" x 1/2" Connector	2

### Tools Required For Installation:

5/16" Nut Driver or Socket With Ratchet  
Phillips Screwdriver

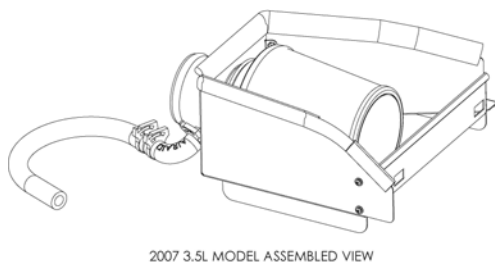

2007 3.5L MODEL ASSEMBLED VIEW

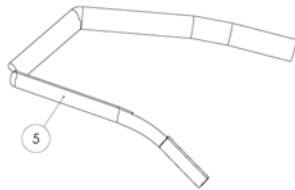

SEE STEP #8 FOR 3.5L OR STEP #9 FOR 2.7L ENGINE VACUUM HOSE APPLICATION

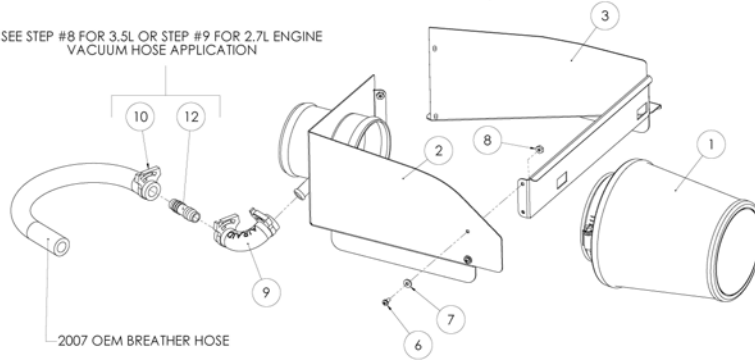

2007 OEM BREATHER HOSE

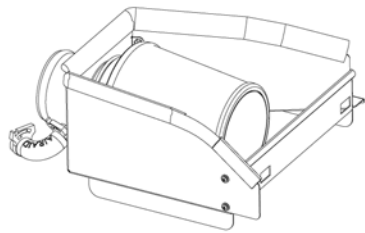

2005-06 3.5L MODEL ASSEMBLED VIEW



**1. Disconnect the negative battery cable.** Remove the breather hose from the factory air box lid and valve cover.  
**2.7L Engines:** remove the hard plastic breather tube at the elbow near the back of the valve cover.

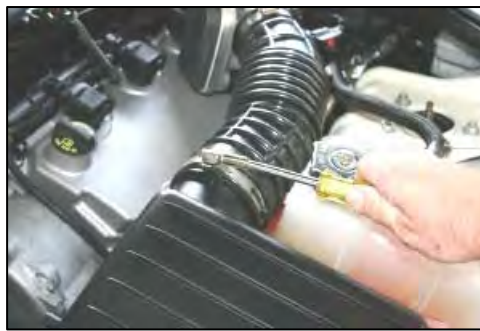

**2.** Loosen the hose clamp on the factory intake tube, located at the air box lid.

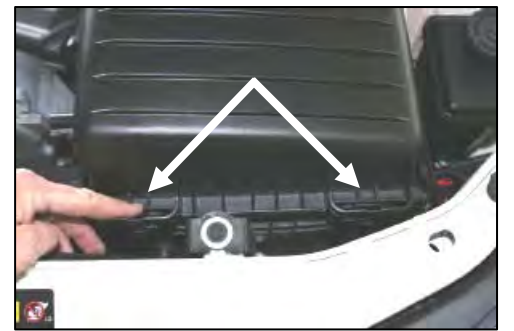

**3.** Remove the airbox lid by pulling the tabs towards the front of the car. Then, lift the lid up and slide it forward, and remove it from the bottom of the airbox.



**4.** Remove the factory air filter from the bottom of the airbox.

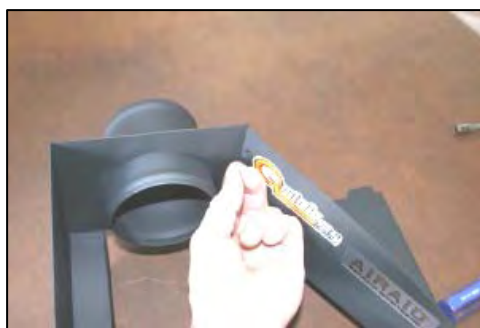

**5.** Assemble the Quick Fit panels (#2, #3) using four 6-32x 5/16" screws (#5), #6 flat washers (#6), and 6-32 keps nuts (#7).



**6.** Slide the 1/2" rubber elbow (#8) onto the breather fitting on the side of the Quick Fit panels. Install 2 #18 speed clamps (#9), one over each end of the elbow, (*Do not tighten the clamps at this time.*)



**7.** Slide the three tabs on the back of the Quick Fit panels into the factory airbox. (*For 2005-2006 models, make sure the 1/2" rubber elbow (#8) slides onto the valve cover breather nipple.*) Push the front of the Quick Fit panels down, until the locking tabs snap into place. **2.7L Engines:** Skip to step #9.

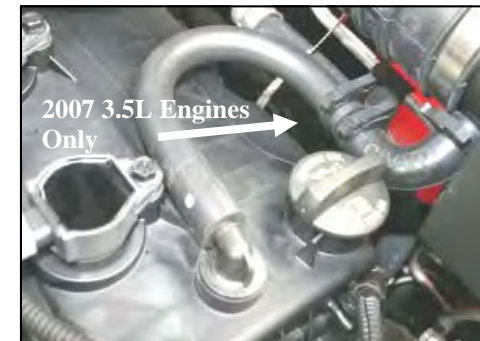

**8. For 2007 3.5L Engines,** (shown above), slide one end of the 1/2" x 1/2" connector (#10) into the rubber elbow. Slide the other end into the factory breather hose. Install one speed clamp (#9) over the factory breather hose and 1/2" connector as shown.

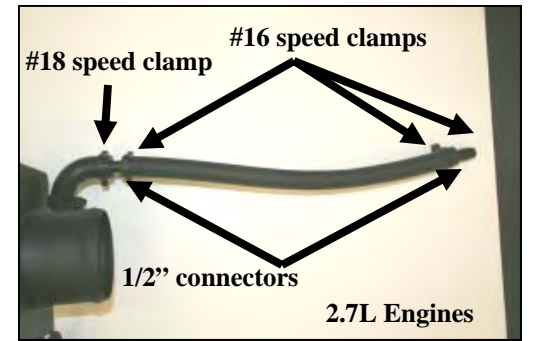

**9. 2.7L Engines:** Install the two 1/2" connectors (#12), into each end of the supplied breather hose (#4). Connect the breather hose to the rubber elbow on the Quick Fit Panel using one #18 speed clamp (#10), and one #16 speed clamp (#11). Install one #16 speed clamp on the opposite end of the hose as shown.



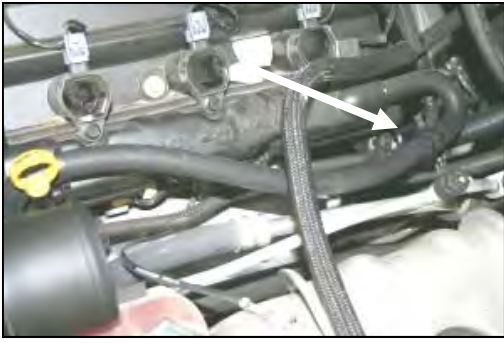

**10. For 2.7L Engines:** After installing the Quick Fit Panels, (Refer to step #7), connect the breather hose to the factory elbow at the back of the valve cover using one #16 speed clamp. (Factory intake tube removed for instruction purposes).



**11.** Slide the Airaid Premium Filter (#1) onto the Quick Fit panel tube, and tighten the hose clamp. Install the factory intake tube onto the opposite end of the Quick Fit panel tube, and tighten the hose clamp. Tighten the speed clamps on the breather hose, and the 1/2" rubber elbow.



**12.** Install the weather strip (#4) on the top of the Quick Fit panels. (Hint: Start at one end and work all the way to the other end).

**13. Double check your work!**

Make sure there is no foreign material in the intake path. Make sure all clamps, hoses, bolts, and screws are tight.

**14. Reconnect the negative battery cable!**

*Before!*

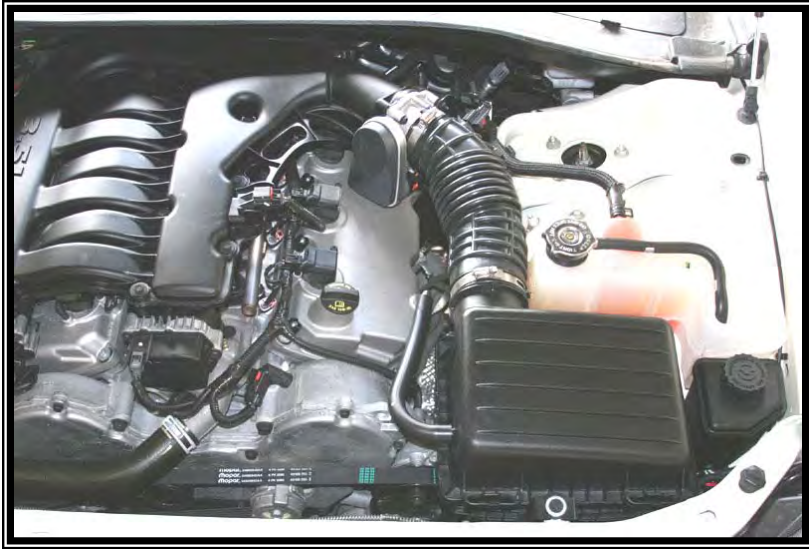

*After!*



Thank you for purchasing the Airaid Intake System. Contact Airaid @ (800) 498-6951 8:00 AM - 5:00 PM MST weekdays for questions regarding fit or instructions that are not clear to you. Your Airaid Intake System was carefully inspected and packaged. Check that no parts are missing, or were damaged during shipping. If any parts are missing, contact Airaid. The air filter element is protected from direct exposure to water and debris; care should be taken not to drive through deep water. WATER INGESTION IS THE DRIVERS RESPONSIBILITY!

*SynthaMax*<sup>®</sup>

**Do Not Oil**



**Synthamax Air Filters do not require oil.** Service air filter as needed by cleaning with common non-petroleum all-purpose household cleaner and water. Simple Green<sup>®</sup>, Formula 409<sup>®</sup> or equivalent works great. Apply cleaner to outside of air filter and allow to soak. Then flush filter clean from the inside out with a garden hose and repeat steps if necessary. Do not apply high pressure water or air to clean filter. Allow filter to air dry and reinstall.