



Installation Instructions

For Part Numbers:

- 400-339 720-478 Airaid Oiled Media Filter
- 401-339 721-478 SynthaMax Dry Media Filter - Red
- 402-339 722-478 SynthaMax Dry Media Filter - Black
- 403-339 723-478 SynthaMax Dry Media Filter - Blue

2015 Ford Expedition
2015 Lincoln Navigator
3.5L EcoBoost V6

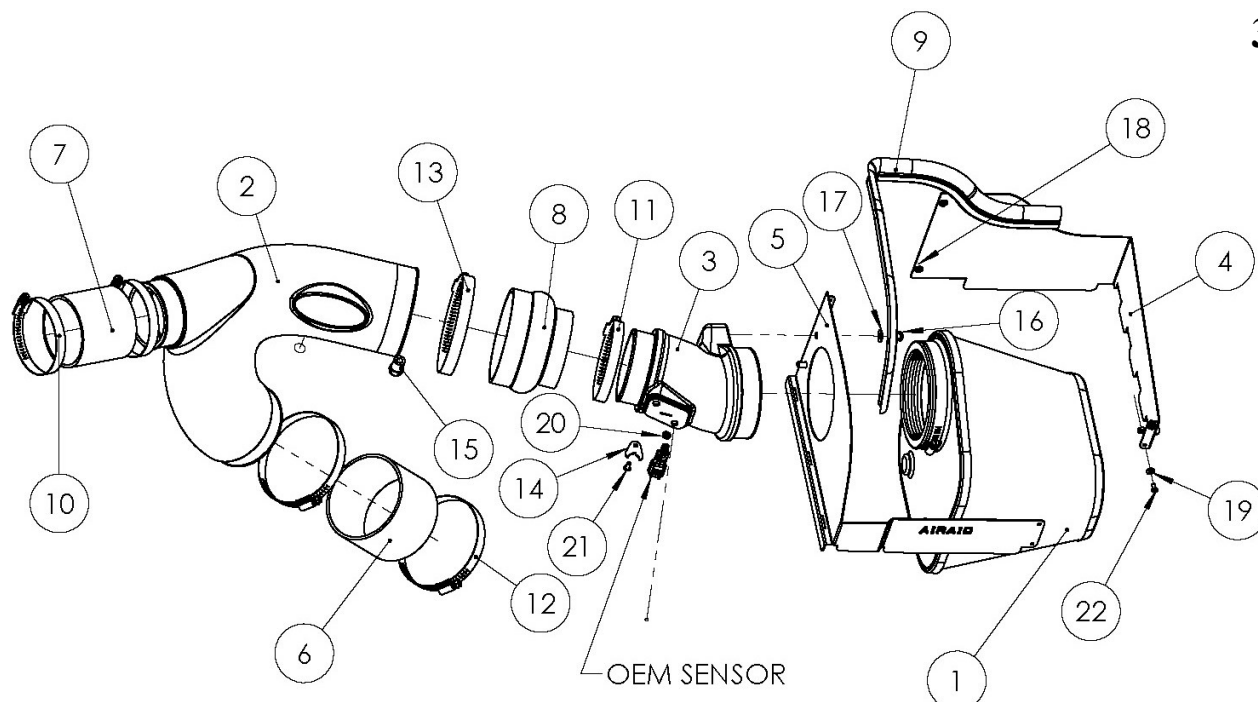

Component Identification

1	AIRAID PREMIUM AIR FILTER	1
2	INTAKE TUBE	1
3	SENSOR TUBE	1
4	REAR PANEL	1
5	FRONT PANEL	1
6	4" COUPLER	1
7	3" COUPLER	1
8	HUMP HOSE	1
9	WEATHER STRIP, 22"	1
10	HARDWARE AND INSTRUCTIONS	1
11	#48 HOSE CLAMP	2
12	#56 HOSE CLAMP	1
13	#64 HOSE CLAMP	2
14	#68 HOSE CLAMP	1
15	SENSOR RETAINER	1
16	1/4" NPT PLUG	1
17	1/4-20 BUTTON HEAD SCREW	2
18	1/4" FLAT WASHER	2
19	6-32 KEP NUT	4
20	#6 FLAT WASHER	4
21	#8 FLAT WASHER	1
22	8-32 BUTTON HEAD SCREW	1
22	6-32 PAN HEAD SCREW	4

Full color instructions can be viewed on our web site at Airaid.com. Use the **Product Search** function to find your part number, and click **View Details**.

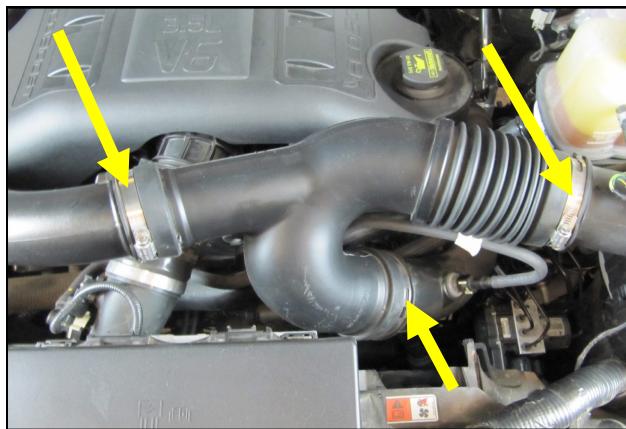

1. Disconnect The Negative Battery Terminal.
Loosen the 3 clamps on the factory intake tube and remove it from the vehicle.

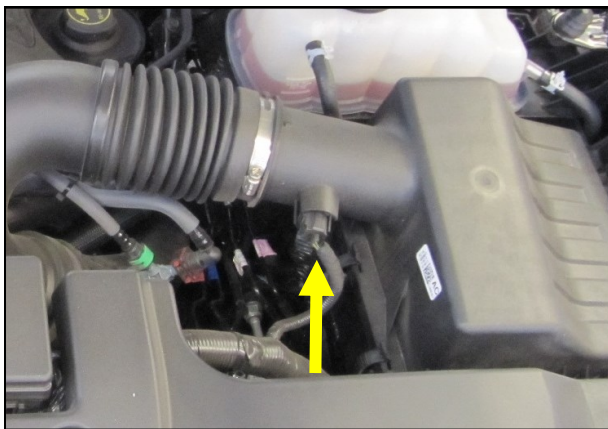

2. Disconnect the wiring harness from air sensor in the air box lid. Unclip the air box lid and remove it and the factory air filter from the vehicle. The lower half of the factory air box is to remain in the vehicle.

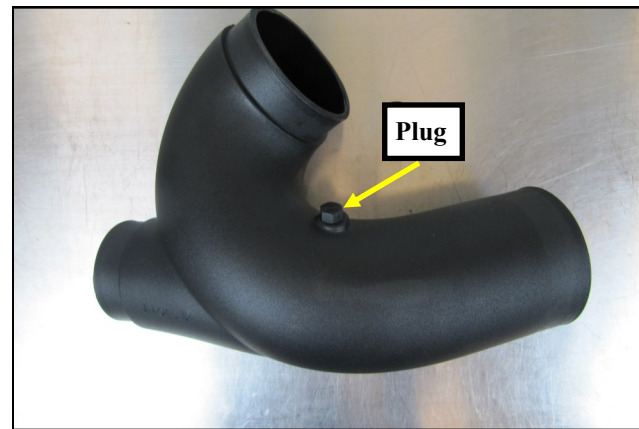

3. Install the 1/4" Plug into the Airaid Intake Tube as shown.

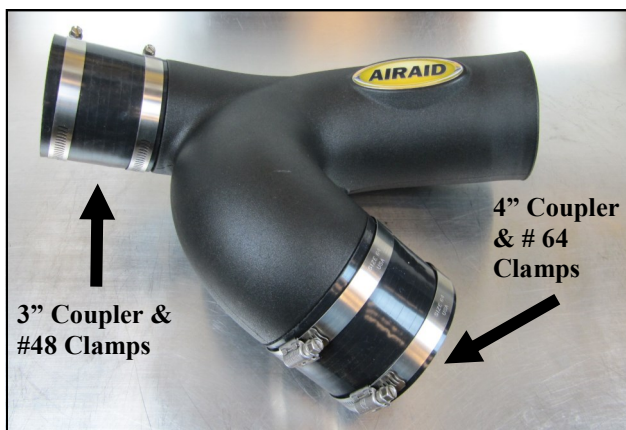

4. Slide the Couplers and Clamps onto the Intake tube as shown.



5. Install the Airaid Intake Tube onto the factory turbo plumbing and tighten the Clamps.

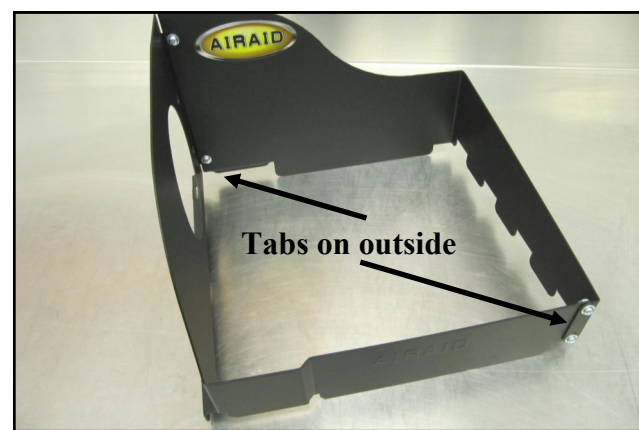

6. Assemble the Front and Rear Panels as shown with the tabs on the outside of the assembly. Use the four 6-32 Button Head Screws, #6 Flat Washers, and #6 Kep Nuts to secure the assembly.



7. Transfer the air temp sensor from the OEM airbox into the Airaid Sensor Tube as shown with the locking tab aimed at the threaded insert.

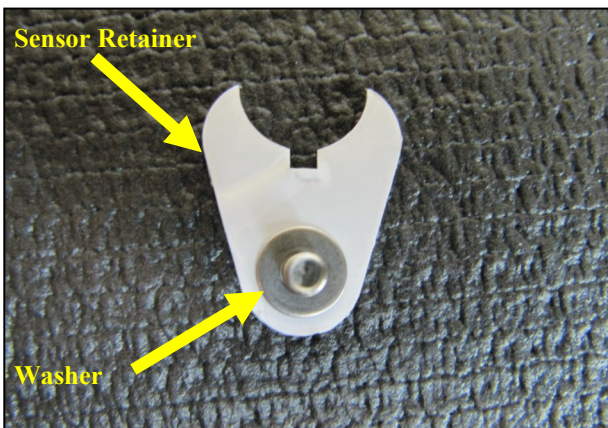

8. Insert the 8-32 Button Head Screw into the Sensor Retainer with the #8 Flat Washer on the opposite side.



9. Install the Sensor Retainer with Washer and Screw on to the Sensor Tube as shown.

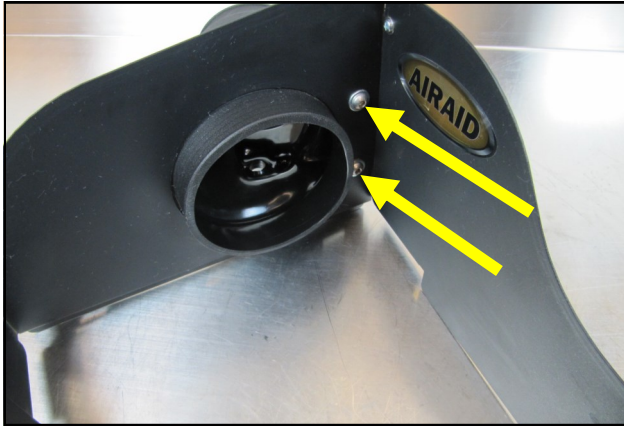

10. Mount the Sensor Tube onto the Panel Assembly and secure using the two 1/4-20 Button Head Screws and 1/4" Flat Washers.

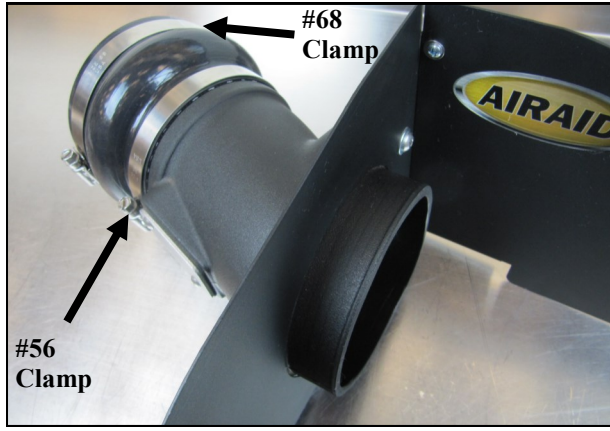

11. Slide the Hump Hose and Clamps onto the Sensor Tube as shown.

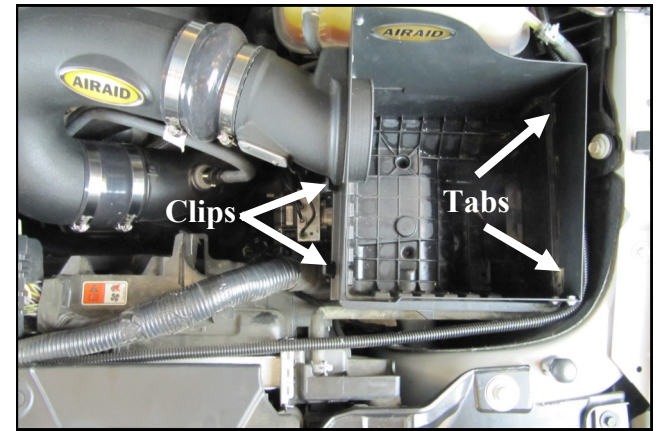

12. Install the Tube and Panel assembly onto the Airaid Intake Tube first, then insert the Panel tabs into the factory air box slots. Adjust the assembly until the OEM air box clips can positively engage the Panels and lock.

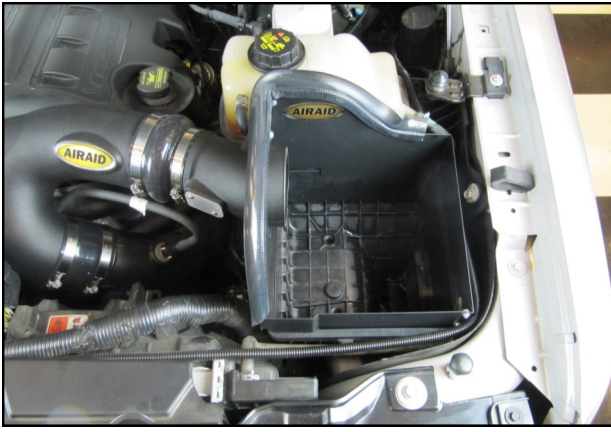

13. Tighten the Clamps on the Hump Hose, reconnect the MAF or MAP sensor and install the Weather Strip as shown, with the contour rolling away from the Filter area.



14. Install the Airaid Premium Filter onto the Sensor Tube and tighten the clamp.



15. Double check your work. Make sure there is no foreign material in the intake path. Make sure all clamps, hoses, bolts, and screws are tight. Double check the hood clearance. **Reconnect the negative battery cable.**

Thank you for purchasing the Airaid Intake System. Contact Airaid @ (800) 498-6951 8:00 AM - 5:00 PM MST weekdays for questions regarding fit or instructions that are not clear to you. Your Airaid Intake System was carefully inspected and packaged. Check that no parts are missing, or were damaged during shipping. If any parts are missing, contact Airaid. The air filter element is protected from direct exposure to water and debris; care should be taken not to drive through deep water. WATER INGESTION IS THE DRIVERS RESPONSIBILITY! The air filter is reusable and should be cleaned periodically.

FILTER IDENTIFICATION

720-478 Airaid Oiled Media
722-478 Airaid SynthaMax Dry Media - Black

721-478 Airaid SynthaMax Dry Media - Red
723-478 Airaid SynthaMax Dry Media - Blue

For your Oiled media filter we suggest using the AIRAID Filter Tune-Up Kit!



P/N 790-551 Aerosol Spray
P/N 790-550 Squeeze Spray



SynthaMax[®]

Do Not Oil

Synthamax Air Filters do not require oil. Service air filter as needed by cleaning with common non-petroleum all-purpose household cleaner and water. Simple Green[®], Formula 409[®] or equivalent works great. Apply cleaner to outside of air filter and allow to soak. Then flush filter clean from the inside out with a garden hose and repeat steps if necessary. Do not apply high pressure water or air to clean filter. Allow filter to air dry and reinstall.