

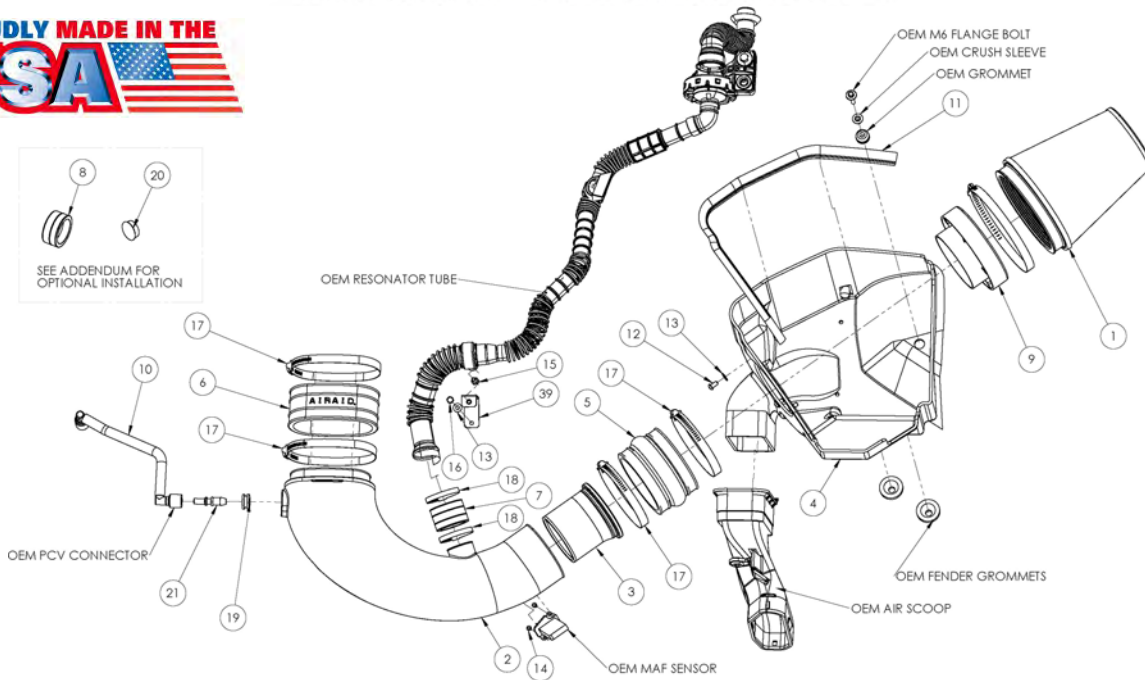

INTAKE SYSTEMS

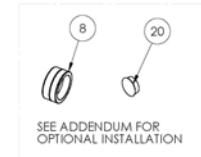

Installation Instructions Part Number 450-238 2010 Ford Mustang GT 4.6L V-8

Packing List:

#1	700-461	Airaid Premium Filter	1
#2	KIT238T	Airaid Intake Tube	1
#3	KIT238I	Modular Venturi Tube (MVT)	1
#4	KIT238CAD	Cool Air Dam	1
#5	KITHUMPHS05	Urethane Hump Hose	1
#6	KITCOUPLER07	Urethane Oval Coupler	1
#7	KITCOUPLER19	Urethane 1 3/4" Coupler	1
#8	KITCAP01	Urethane Cap*	1
#9	KIT1121MAFADA	Filter Adapter	1
#10	KITHOSE06	3/8"x12" Hose	1
#11	KITWSTRIP03	Weather Strip 25"	1
	KIT238HP	Hardware & Instructions	1
#12	KIT15DHC3050	1/4-20 Button Head Bolt	3
#13	KIT09FWZ019	1/4" Flat Washer	4
#14	KIT15BHC3038	8-32 x 3/8" Button Head Bolt	2
#15	KIT25C87HCSS	1/4-20 Hex Head Bolt	1
#16	KIT60C120HCS	6mm x 12mm Hex Bolt	1
#17	KITHS72	#72 Hose Clamp	4
#18	KITCLAMP60SS	40-60mm Hose Clamp	2
#19	KITGRMT03	Grommet	1
#20	KITPLUG01	Firewall Plug*	1
#21	KITFITTING05_REV_B	Aluminum Fitting	1
#22	KIT238B	Resonator Tube Bracket	1
	KITBIT01	#20 Torx Bit	1

Tools Required For Installation:

5/32" Allen Wrench & 3/32" Allen Wrench
1/4", 5/16", 10mm Deep, 13mm Sockets
Ratchet & Extension, Pliers, Screwdriver, Razor Blade

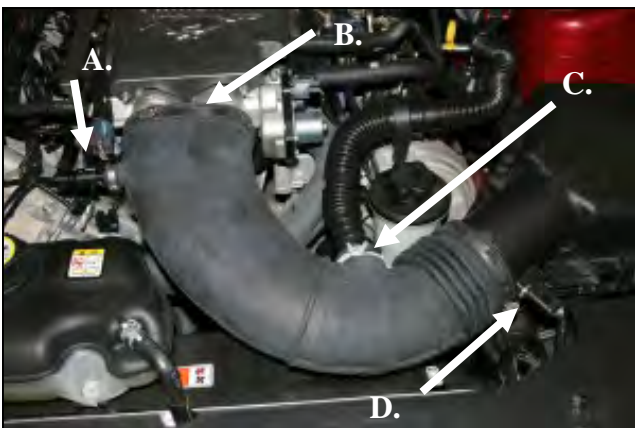

1. **Disconnect the negative battery cable.**
A.) Push the green plastic tabs on each end, and remove the breather hose from vehicle. (Save for later use). B.) Loosen the hose clamp that secures the intake tube to the throttlebody. C.) Squeeze the clamp and disconnect the resonator from the air intake tube. D.) Slide the red tab, and disconnect the wiring harness from the Mass Air Flow sensor (MAF).

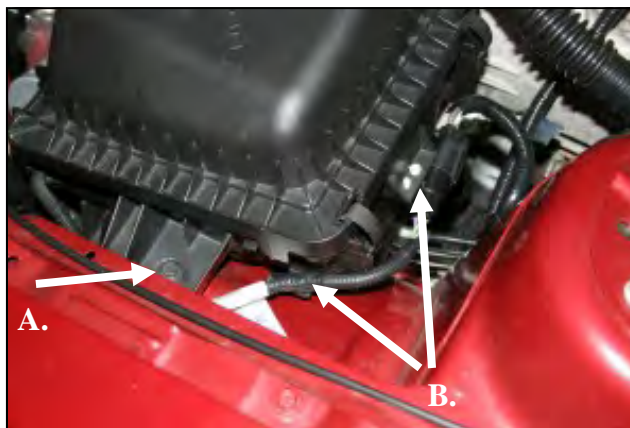

2.A.) Using a 10mm socket, remove and save the bolt that secures the airbox to the fender.
B.) Using a flat blade screwdriver, **carefully**, push, or pry the 5 wiring loom anchors from the factory airbox.

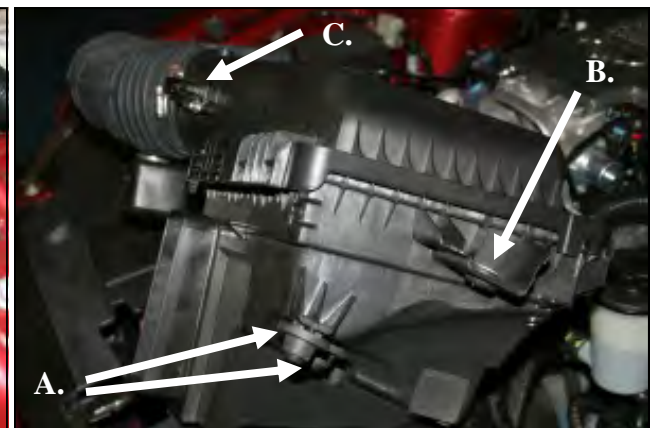

3. Grab the airbox and tube and roll it forward while lifting up to dislodge it from the intake scoop. Remove the assembly from the vehicle. A.) Remove the two factory grommets and then replace them back into the two holes in the inner fender. B.) Remove the steel sleeve and grommet and save for reinstallation later. C.) Using the provided #20 Torx bit, remove the two screws and the MAF sensor from the tube.

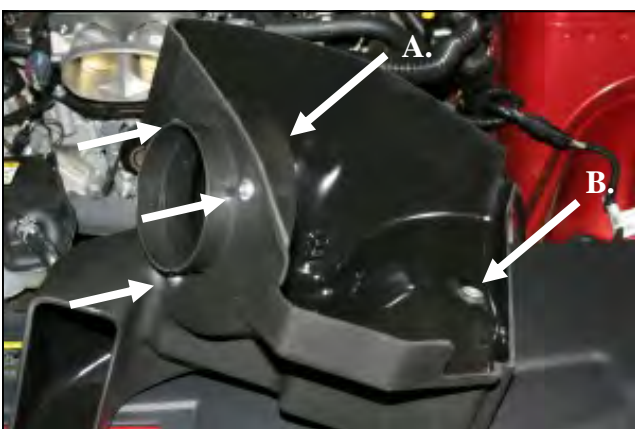

4. A.) Install the filter adapter (#9) using three 1/4-20 button head bolts (#12), and flat washers (#13) into the Airaid Cool Air Dam (CAD) (#4) as shown. B.) Reinstall the small grommet and sleeve (removed in step #3) into the hole in the CAD.



5. Turn the CAD so that the bottom faces the left fender as shown. Now reinstall the wiring loom anchors into their respective holes starting at the back of the CAD with the two hole anchor and work your way underneath and towards the front. The last anchor nearest the MAF sensor is not anchored.



6. Install the CAD into the vehicle making sure that the scoop provision in the CAD aligns with the factory scoop, and the two locating pins on the bottom align with the factory grommets. Next reinstall the factory bolt that was removed in step #2 thru the steel sleeve and grommet and into the inner fender. Make sure that the wiring harness is not pinched under the CAD.



7. Install the provided hump hose (#5) onto the filter adapter using two #72 hose clamps (#17) as shown. Leave the two hose clamps loose for now.



8. Slide the Modular Venturi Tube (#3) into the Airaid intake tube (#2) making sure to align the two slots for the MAF sensor. Next install the MAF sensor into the intake tube using two provided 8-32x3/8" screws (#14).
Do Not Use The Factory Screws!



9. Lift up on the intake resonator tube to disengage it from the stud securing the power steering reservoir. Using a deep 10mm socket, remove the stud and save it for a possible optional install. See step #18.

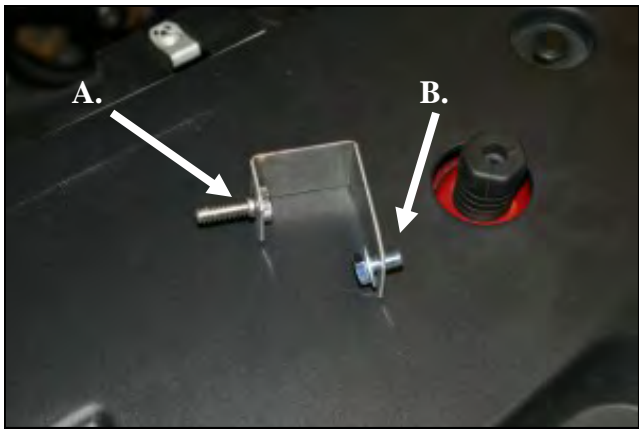

10.A.) Thread the 1/4-20 hex bolt (#15) into the resonator bracket (#22) and tighten as shown.
 B.) Slide the 6mmx12mm (#16) hex bolt thru one flat washer (#13) and into the hole in the resonator bracket.



11. Install the bracket assembly from step #10 as shown. This bracket and 6mm bolt will secure the power steering reservoir and replaces the stud removed in step #9.

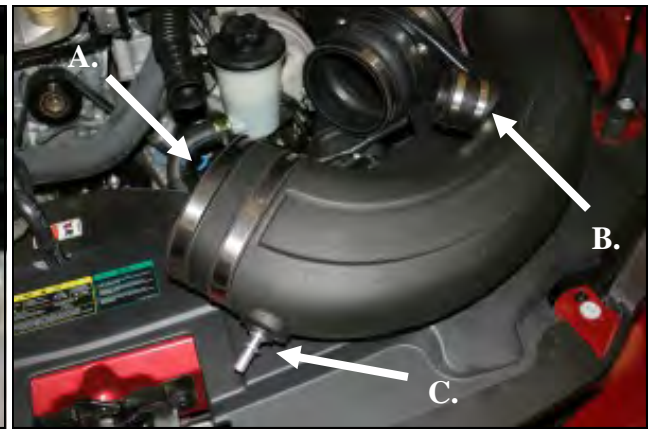

12.A.) Install the oval coupler onto the intake tube using two #72 hose clamps (#17). Leave the clamps loose for now. B.) Install the 1 3/4" coupler (#7) onto the intake tube using two #28 hose clamps (#18) as shown. Tighten *only* the clamp against the tube for now. C.) Install the provided grommet (#19) into the intake tube and then install the aluminum fitting (#21) into the grommet as shown.



13. Install the air intake tube into the hump hose first, and then onto the throttlebody. Adjust for fit and then tighten all four hose clamps. Next, reinstall the factory resonator tube into the 1 3/4" coupler and tighten the hose clamp. Now "reseat" the resonator tube onto the bracket.



14. Install the Airaid Premium Filter (#1) onto the filter adapter and tighten the hose clamp. Next, install the weatherstrip (#11) onto the top of the CAD as shown starting near the radiator and working your way towards the left fender.



15. **VERY CAREFULLY!** Without cutting thru the connectors, cut the factory breather tube on each end just enough to remove the factory connectors.



16. Install the two factory connectors from step #15 into each end of the supplied 3/8"x12" breather hose (#10). Now reattach one connector to the valve cover, and the other end to the aluminum fitting on the intake tube.

17. Double check your work!

Make sure there is no foreign material in the intake path. Make sure all clamps, hoses, bolts, and screws are tight. Double check the hood clearance!

Reconnect the negative battery cable!

18. Optional Installation Notice!

Airaid has made provisions to eliminate the factory air intake resonator if you so desire. The removal of the resonator has no effect negative effect on the performance of this kit. Please see the addendum instruction sheet included with these instructions for further information.

Thank you for purchasing the Airaid Intake System. Contact Airaid @ (800) 498-6951 8:00 AM - 5:00 PM MST weekdays for questions regarding fit or instructions that are not clear to you. Your Airaid Intake System was carefully inspected and packaged. Check that no parts are missing, or were damaged during shipping. If any parts are missing, contact Airaid. The air filter element is protected from direct exposure to water and debris; care should be taken not to drive through deep water. WATER INGESTION IS THE DRIVERS RESPONSIBILITY! The air filter is reusable and should be cleaned using the Airaid Filter Tune-Up Kit periodically.

Before!



After!



Don't Forget Your AIRAID Filter Tune-Up Kit!



P/N 790-551 Aerosol Spray
 P/N 790-550 Squeeze Spray



Instructions Revision
 Date: 06/24/10



INTAKE SYSTEMS

Addendum To:

**Installation Instructions
Part Number 450-238
2010 Ford Mustang GT
4.6L V-8**

As an option, Airaid has made a provision for those who would like to remove the air intake sound resonator on your 4.6L engine. The following instructions will allow you to remove the resonator while still retaining maximum performance. You can perform the steps below after you install the complete kit, or you can substitute these steps while you do the install.



1. Loosen the clamps on the resonator tube coupler and disconnect it from the intake tube. Pull up on the resonator tube to release it from the resonator



2. Using one of the clamps from the resonator coupler, install the urethane cap onto the intake tube and tighten the clamp.



3. Using a 10mm socket, remove the resonator bracket from the power steering reservoir.



4. Replace the resonator bracket and 6mm bolt with the factory stud removed in step #9.



5. Remove the bolt that secures the resonator tube and diaphragm to the left inner fender.



6. Grab the resonator tube between the diaphragm and the firewall and pull up and out to disconnect it from the firewall. Remove the complete resonator assembly from the vehicle.



7. Install the optional firewall plug (#20 on the main page) into the hole in the firewall.

Before!



After!



Instructions Revision
Date: 11/05/09