

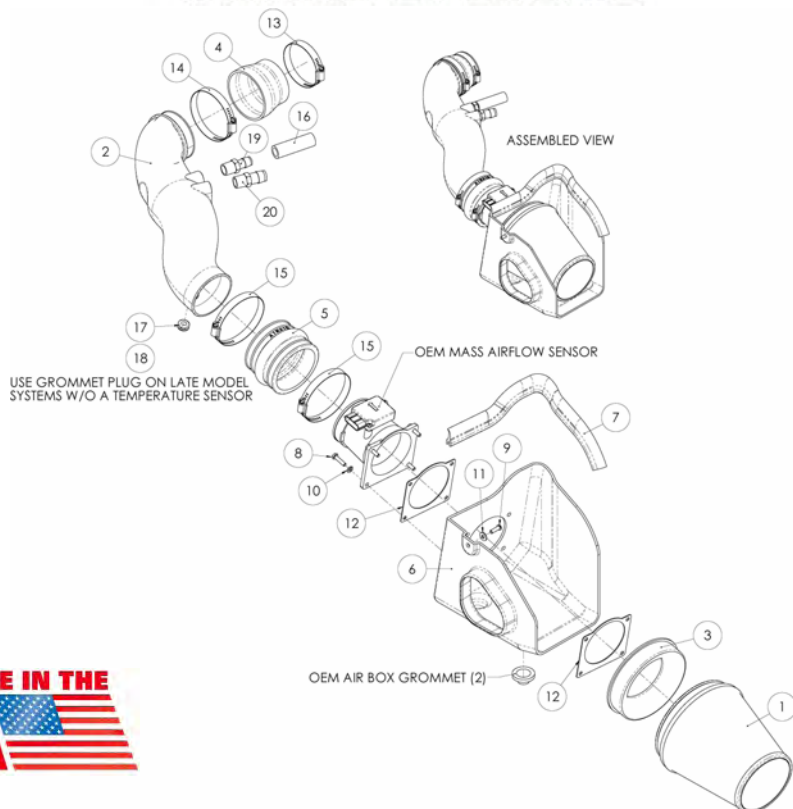

INTAKE SYSTEMS



Installation Instructions Part Number 451-204 99-04 Ford Mustang GT 4.6L V-8

Packing List:

#1	701-462	Airaid Premium Filter	1
#2	KIT204T	Airaid Intake Tube	1
#3	KIT204VS	Velocity Stack	1
#4	KITRDCR05	Reducer Coupler	1
#5	KITHUMPHS03	Urethane Hump Hose	1
#6	KIT204CAD	Cool Air Dam	1
#7	KITWSTRIP03	Weather Strip 17"	1
	KIT204HPS	Hardware & Instructions	1
#8	KIT60C250HCS	M6 - 1 x 25mm Hex Bolt	4
#9	KIT20BHC3060	M6 x 20mm Button Head Bolt	1
#10	KIT09LWZ025	1/4" Lock Washer	4
#11	KIT09FWZ019	1/4" Flat Washer	1
#12	KIT109GAS	MAF Gasket	2
#13	KITHS44	#44 Hose Clamp	1
#14	KITHS56	#56 Hose Clamp	1
#15	KITHS60	#60 Hose Clamp	2
#16	KITHOSE02	5/8" x 3" Hose	1
#17	KITGRMT13	Grommet	1
#18	KITGRMT14	Plug Grommet	1
#19	KITFITTING16	1/2" NPT x 5/8" Barb	1
#20	KITFITTING17	1/2" NPT x 3/4" Barb	1
	KITBIT#T20	T-20 Security Torx Bit	1

Tools Required For Installation:

1/4", 5/16", 10mm Sockets
5/32" Allen Wrench
7/8" Wrench
Ratchet & Extension

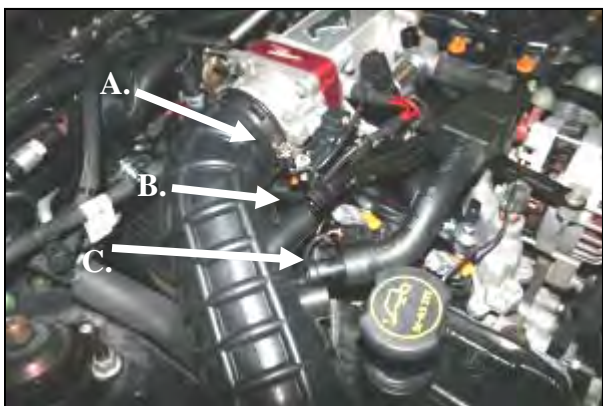

1. **Disconnect the negative battery cable.**
A.) Loosen the hose clamp on the factory intake tube at the throttlebody. B.) Disconnect the crankcase breather tube from the factory air intake tube. C.) Disconnect the idle bypass hose from the factory air intake tube and remove the hard plastic 3/4" coupler from inside the rubber hose.

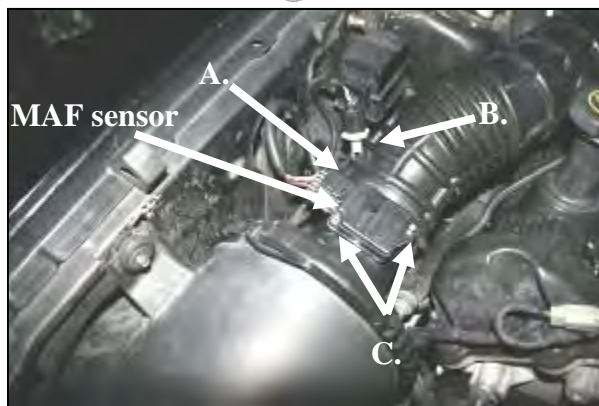

2. A.) Loosen the factory intake tube hose clamp on the Mass Air Flow (MAF) sensor housing. B.) Carefully remove the intake air temperature sensor from the factory intake tube (1999-01 models). C.) Using the supplied T-20 torx bit, remove two screws, and remove the MAF sensor from the MAF housing. Set the temp sensor and MAF sensor to the side for reinstallation later.

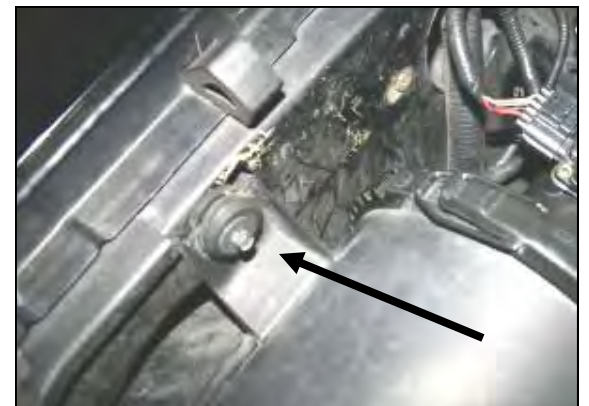

3. Remove the bolt that holds the factory air filter canister to the inner fender. Next remove the factory air intake tube from the throttlebody, and then the MAF housing. Now with a twisting motion remove the factory air filter canister from the vehicle.



4. Remove the two factory grommets from the bottom of the factory air filter canister and reinstall them into the holes in the inner fender.

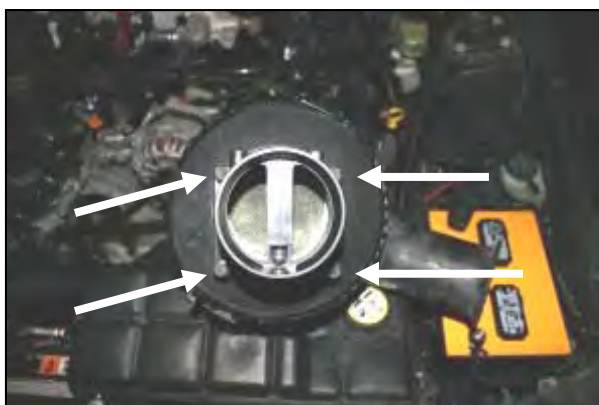

5. Remove the four bolts that hold the MAF housing to the factory air filter canister. The bolts will not be reused, but the MAF housing will be used in the next step.

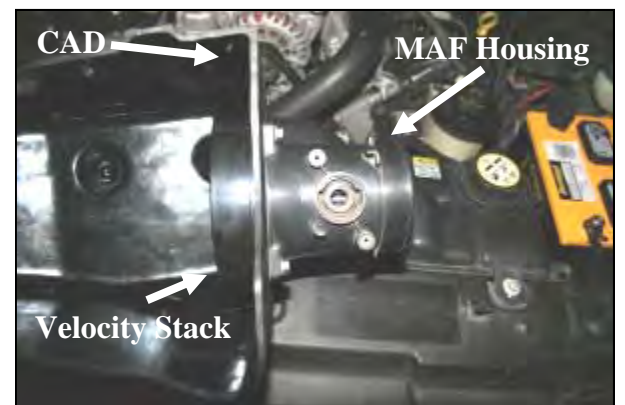

6. Mount the factory MAF housing to the Airaid Cool Air Dam (#6) using four 6mmx25mm bolts (#8), four lock washers (#10), two MAF gaskets (#12), and one velocity stack (#3). Refer to the line drawing at the top of this page for the proper sequence of how to install the parts.

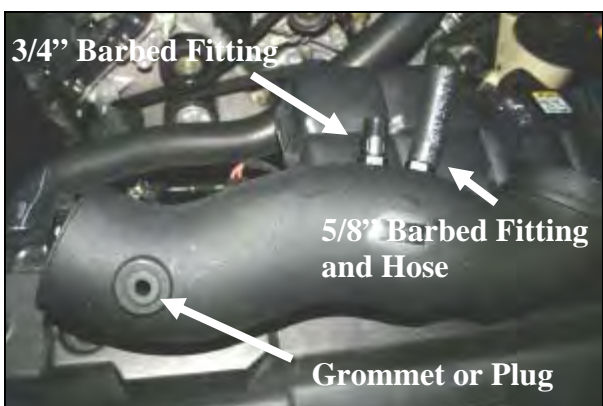

7. If your vehicle is equipped with an intake temp sensor (1999-01), install the supplied grommet (#17) into the hole in the Airaid Intake Tube (#2). On later models (2002-04), install the grommet plug (#18). Next install the two barbed fittings (#19 & #20) into the tube as shown. Now install the 5/8" x 3" hose (#16) onto the 5/8" barbed fitting.

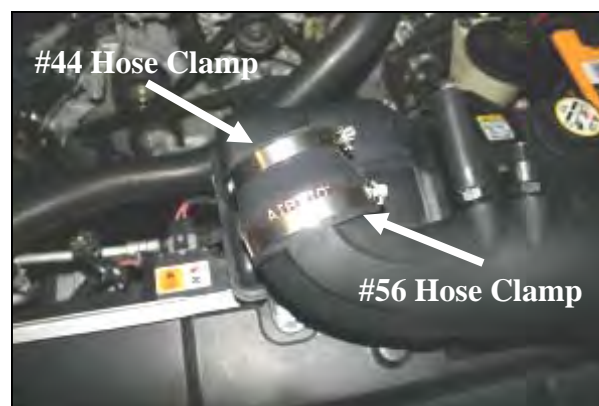

8. Install the reducer coupler (#4) onto the throttlebody end of the Airaid Intake Tube using the #56 hose clamp (#14) on the tube end, and the #44 hose clamp (#13) on the small end. Tighten *only* the large #56 clamp at this time.

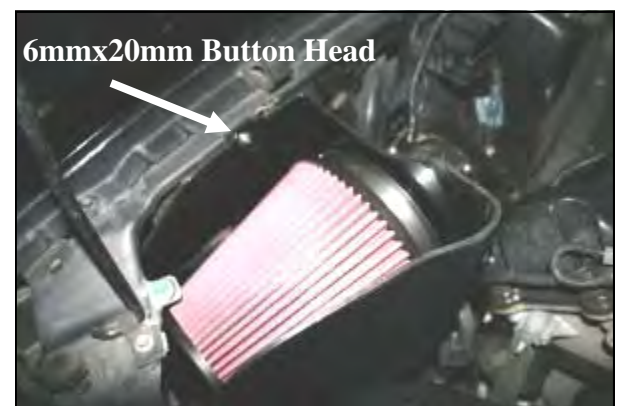

9. Install the Airaid Premium Filter (#1) onto the velocity stack inside of the CAD as shown and tighten the clamp. Next install the CAD assembly into the vehicle aligning the grommet posts into the factory grommets in the inner fender. Now secure the CAD to the inner fender well using the 6mmx20mm button head bolt (#9), and flat washer (#11).



10. Install the hump hose (#5) onto the factory MAF housing using two #60 hose clamps (#15) as shown. Tighten *only* the clamp on the housing at this time.

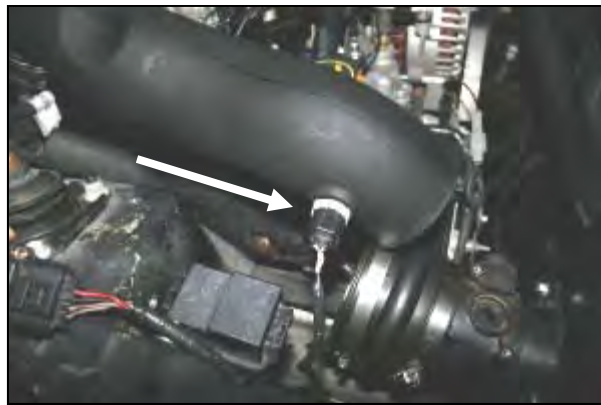

11. On 1999-01 Models, Carefully install the factory intake temp sensor into the grommet in the Airaid Intake Tube.

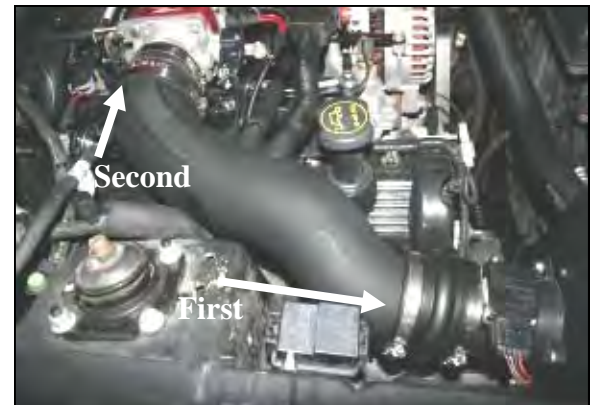

12. Install the Airaid Intake Tube into the hump hose first, and then onto the throttlebody. Adjust for fit, and then tighten the two remaining hose clamps. Reconnect the crankcase breather hose to the 5/8"x 3" hose, and connect the idle bypass hose to the 3/4" barbed fitting. Now reinstall the MAF sensor onto the MAF housing using the factory screws.



13. Install the supplied weather strip (#7) onto the top of the CAD starting at the fender and working your way towards the radiator.

14. Double check your work!

Make sure there is no foreign material in the intake path. Make sure all clamps, hoses, bolts, and screws are tight. Double check the hood clearance!

15. Reconnect the negative battery cable!

Thank you for purchasing the Airaid Intake System. Contact Airaid @ (800) 498-6951 8:00 AM - 5:00 PM MST weekdays for questions regarding fit or instructions that are not clear to you. Your Airaid Intake System was carefully inspected and packaged. Check that no parts are missing, or were damaged during shipping. If any parts are missing, contact Airaid. The air filter element is protected from direct exposure to water and debris; care should be taken not to drive through deep water. WATER INGESTION IS THE DRIVERS RESPONSIBILITY!

Before!



After!



SynthaMax

Do Not Oil



Synthamax Air Filters do not require oil. Service air filter as needed by cleaning with common non-petroleum all-purpose household cleaner and water. Simple Green®, Formula 409® or equivalent works great. Apply cleaner to outside of air filter and allow to soak. Then flush filter clean from the inside out with a garden hose and repeat steps if necessary. Do not apply high pressure water or air to clean filter. Allow filter to air dry and reinstall.