

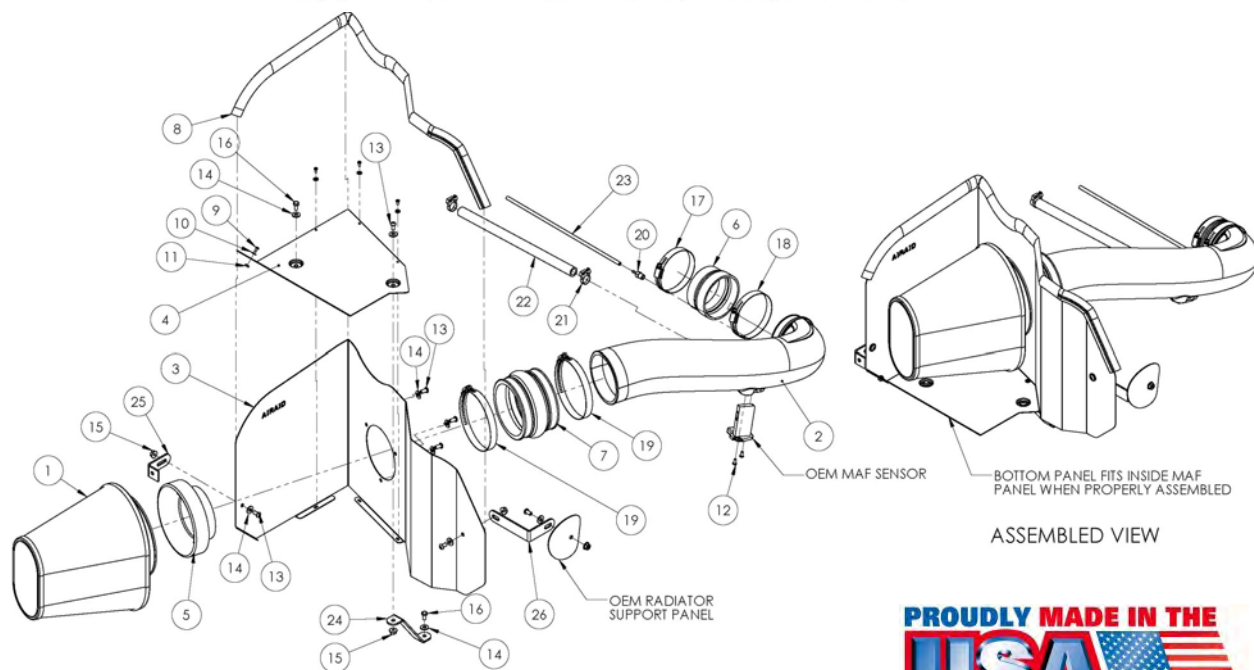

INTAKE SYSTEMS



Installation Instructions

Part Number 510-223

2007-09 Toyota Tundra 4.7L V-8

2008-09 Toyota Sequoia 4.7L V-8

Packing List:

#1	720-472	Airaid Premium Filter	1
#2	KIT223T	Airaid Intake Tube	1
#3	KIT213MAFC	MAF Panel	1
#4	KIT213BPC	Bottom Panel	1
#5	KIT112MAFADA	Filter Adapter	1
#6	KITRDCR04	Reducer Coupler	1
#7	KITHUMPHS05	Urethane Hump Hose	1
#8	KITWSTRIP02	Weather Strip 37 1/2"	1
	KIT223HP	Hardware & Instructions	1
#9	KIT6C31MXPPZ	6-32x5/16" Phillips Head Screw	4
#10	KIT6NWSAPZ	#6 Flat Washer	4
#11	KIT6CNKEPZ	6-32 Keps Nut	4
#12	KIT15BHC3038	8-32 x 3/8" Button Head Screw	2
#13	KIT15DHC3050	1/4-20 x 1/2" Button Head Bolt	7
#14	KIT09FWZ019	1/4" Flat Washer	9
#15	KIT1420WZZF	1/4" Serrated Nut	4
#16	KIT60C120HCS	M6 x 12mm Hex Bolt	2
#17	KITHS52	#52 Hose Clamp	1
#18	KITHS56	#56 Hose Clamp	1
#19	KITHS72	#72 Hose Clamp	2
#20	KITFITTING19	1/8"NPT x 1/8" Barb Fitting	1
#21	KITSNP16M4	#16 Speed Clamp	2
#22	KITHOSE01	1/2" x 13" Breather Hose	1
#23	KITHOSE07	1/8" x 13" Vacuum Hose	1
#24	KIT110FB	#110 Bracket	1
#25	KIT140B	#140 Bracket	1
#26	KIT203B	#203 Bracket	1

Tools Required For Installation:

5/16", 10mm Sockets
Ratchet & Extension
7/16" Wrench
3/32", 5/32" Allen Wrench
Phillips Head Screw Driver

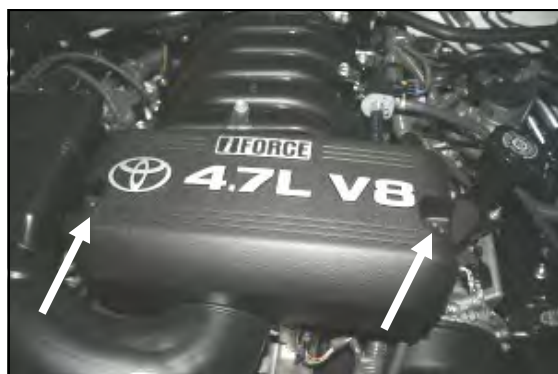

1. Disconnect the negative battery cable.
Using a 10mm socket, remove two nuts and the engine beauty cover. Set them to the side for now, they will be reinstalled in step #14.



2. Using a 10mm socket, loosen the hose clamp that secures the factory intake tube to the throttle body.

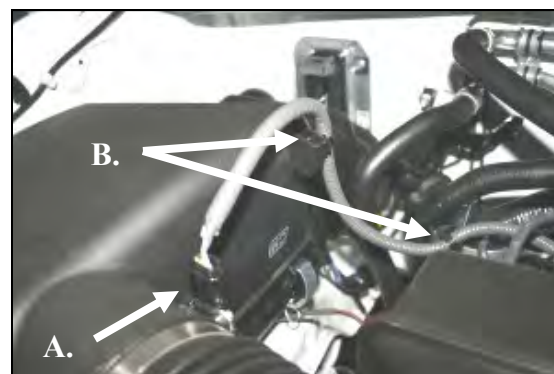

3. A.) Squeeze the tab on the Mass Air Flow (MAF) sensor wiring connector and disconnect it from the sensor. **B.)** Squeeze the tabs on the bottom of the two wiring harness anchors, and remove them from their respective anchor points.



4. Disconnect the breather hose from the back of the factory intake tube and the valve cover. Disconnect the 1/8" vacuum hose from the back of the factory intake tube and the vacuum connection on the engine. These hoses will be replaced with Airaid hoses later in the install.



5. Using a 10mm socket, loosen the two bolts that anchor the factory airbox to the inner fender well. One is on the front of the airbox, and the other is on the rear. Pull the factory intake tube away from the throttle body and remove the complete factory intake assembly from the vehicle.



6. Using a 10mm socket, remove the rear ground anchor bolt on the passenger side inner fender well. Save the bolt, it will be reused in step #8.

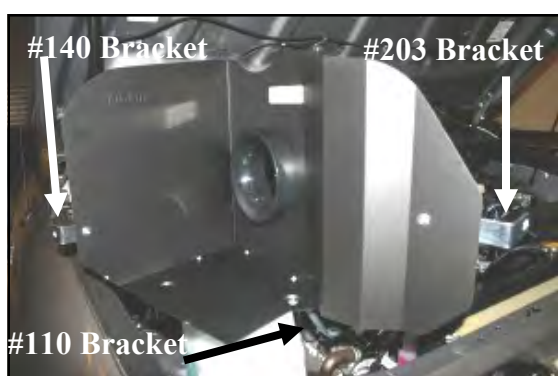

7. Assemble the Cool Air Dam panels (#3 & #4) as shown using four 6-32 screws (#9), washers (#10), and keps nuts (#11). Install the filter adapter (#5) using three 1/4" button head bolts (#13) and washers (#14). Install the 3 brackets (#24), (#25), and (#26) as shown using three 1/4" bolts (#13), washers (#14), and nuts (#15). Just snug the bolts for now, they will be adjusted later.

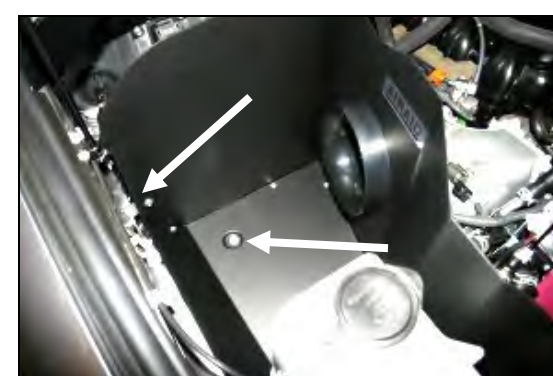

8. Install the CAD assembly into the vehicle. Align the hole in the bottom of the captured nut in the fender well. Install one 6mm hex bolt (#16), and washer (#14). Leave loose for now. Next reinstall the factory bolt removed in step #6, thru the bracket, into the ground anchor in the fender well. This bolt can be tightened now.



9. Remove two Phillips head screws and remove the MAF sensor from the factory intake tube. It will be reinstalled in step #10.

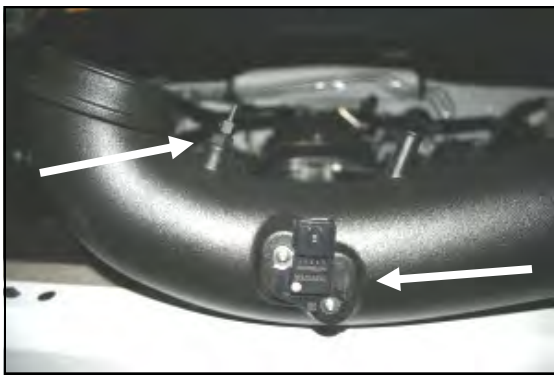

10. Install the 1/8" barbed fitting (#20) into the Airaid intake tube (#2) as shown. Next install the MAF sensor removed in step #9, into the Airaid intake tube and secure it with two 8/32" x 3/8" (#12) button head screws. **Do Not Use The Factory Screws!**

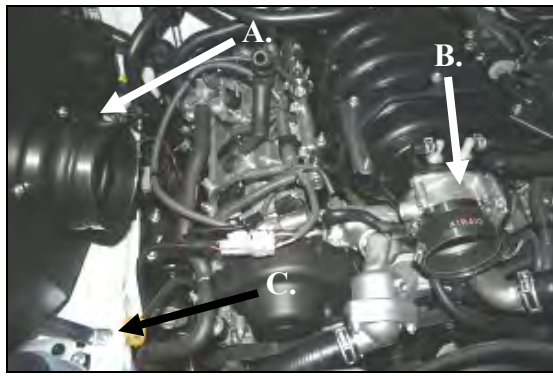

11. **A**) Install the hump hose (#7) onto the filter adapter using two #72 hose clamps (#19). **B**) Install the smaller end of the reducer coupler (#6) onto the throttle body using one #52 hose clamp (#17). Next install the #56 hose clamp (#18) over the coupler and leave it loose. **C**) Now align the #110 bracket (#24) over the captured nut in the fender well and install one 6mm bolt (#16) and washer (#14). Leave loose until final adjustment.

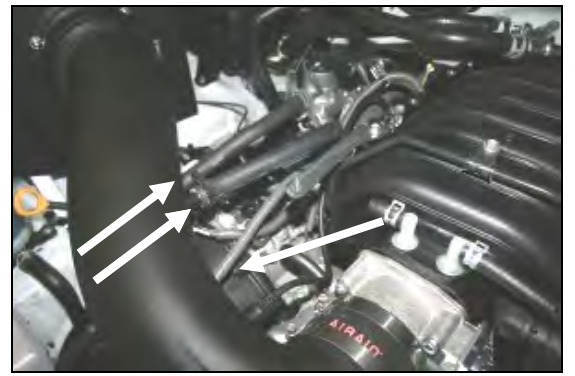

12. Install the Airaid intake tube into the hump hose first and then into the coupler on the throttle body. Adjust for fit, and then tighten all four hose clamps. Next install the 1/2" breather hose (#22) between the Airaid intake tube and the valve cover securing it with one Speed clamp (#21) on each end. Next install the 1/8" vacuum hose (#23) onto the Airaid intake tube, and connect the other end to the vacuum connection on the engine. Reconnect the wiring harness connector to the MAF sensor. Refer to step #4.



13. Fasten the #203 bracket (#26) to the existing hole in the radiator support using one 1/4-20x1/2" button head bolt (#13) washer (#14), and serrated nut (#15). Tighten all nuts and bolts that hold the CAD to the vehicle at this time.



14. Install the Airaid Premium Filter (#1) onto the filter adapter and tighten the clamp. Next install the weather strip (#8) on top of the CAD as shown. For an easier install, start at the fender side of the CAD and work your way towards the radiator. Reinstall the factory beauty cover.

15. Double check your work!

Make sure there is no foreign material in the intake path. Make sure all clamps, hoses, bolts, and screws are tight. Periodically check the tightness of all hose clamps. Double check the hood clearance.

16. Reconnect the negative battery cable!

Before!



After!



Thank you for purchasing the Airaid Intake System. Contact Airaid @ (800) 498-6951 8:00 AM - 5:00 PM MST weekdays for questions regarding fit or instructions that are not clear to you. Your Airaid Intake System was carefully inspected and packaged. Check that no parts are missing, or were damaged during shipping. If any parts are missing, contact Airaid. The air filter element is protected from direct exposure to water and debris, care should be taken not to drive through deep water. WATER INGESTION IS THE DRIVERS RESPONSIBILITY! The air filter is reusable and should be cleaned using the Airaid Filter Tune-Up Kit periodically.

Don't Forget Your AIRAID Filter Tune-Up Kit!



P/N 790-551 Aerosol Spray
P/N 790-550 Squeeze



Instructions Revision
Date: 04.29.13