



Installation Instructions

For Part Number:

883-306 Intake Kit

2014 -15 Kawasaki Teryx

2012-15 Kawasaki Teryx 4

750cc

Component Identification

1.	Airaid Premium Filter	1
2.	Top Panel	1
3.	Bottom Panel	1
4.	Filter Tray	1
5.	Hood Scoop	1
6.	Foam Pre Filter	1
7.	Mounting Bracket	2
8.	Silicone Coupler	1
9.	Urethane Cap	1
10.	#48 Hose Clamp	3
11.	Blind Grommet	1
12.	1/4-20 x 1/2" Button Head screw	4
13.	1/4" Flat Washer	4
14.	1/4-20 x 1/4" Button Head screw	4
15.	#8-32 Thread Cutting Screw	10
16.	Edge Trim, 36"	1
17.	Bubble Sticker	1

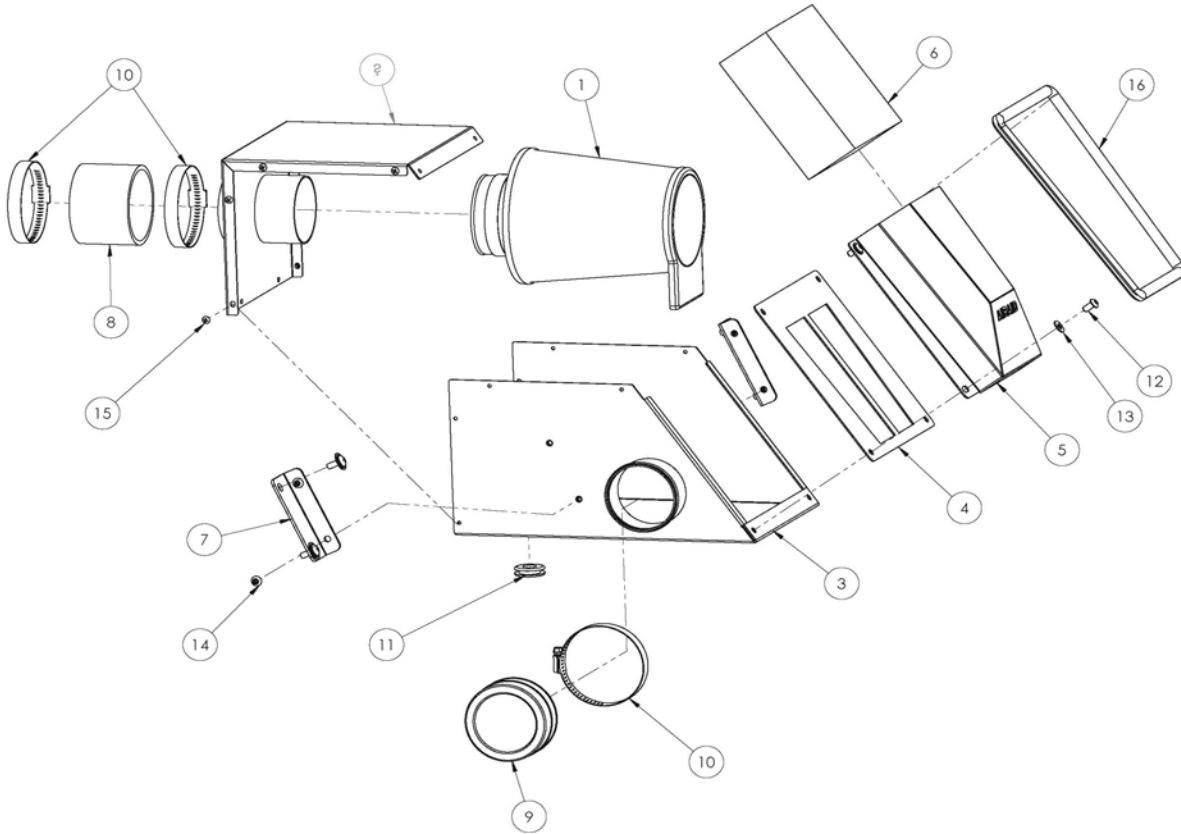

Tools Required For Installation:

In addition to common hand tools, this installation requires the use of a : Hand drill, 1/2" Drill Bit, Jig Saw, Center punch, and hammer.

Full color instructions can be viewed on our web site at Airaid.com. Use the **Product Search** function to find your part number, and click **View Details**.

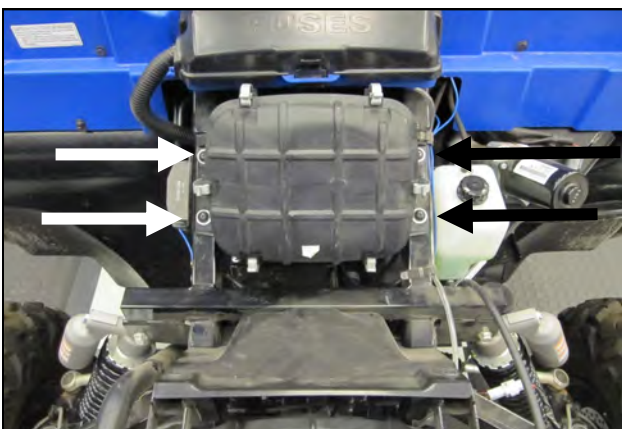

1. Raise the hood of the vehicle. Locate and disconnect the negative battery terminal underneath the airbox. Remove the four airbox bolts and set them aside. They will be reused.

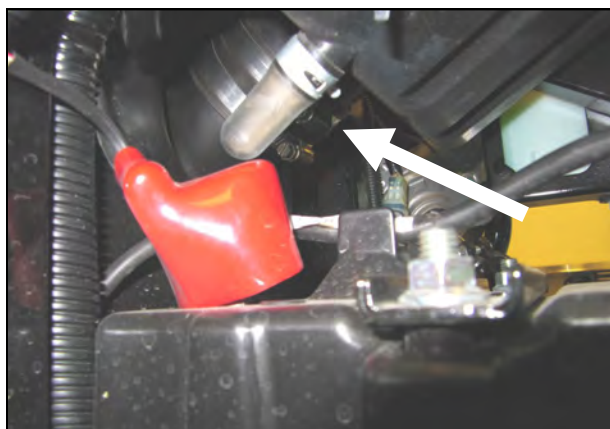

2. Loosen the clamps on the factory airbox couplers.



3. Remove the factory airbox and couplers from the vehicle.

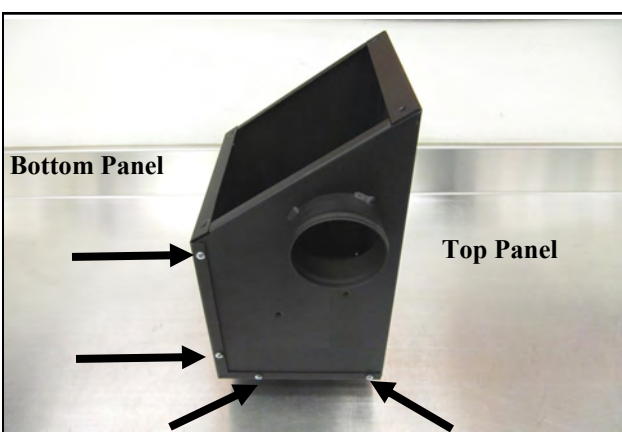

4. Create the Airbox Assembly by sliding the Top Panel (#2) into the Bottom Panel (#3). Use four of the 8-32 Thread Cutting Screws (#15) on each side to secure the panels.

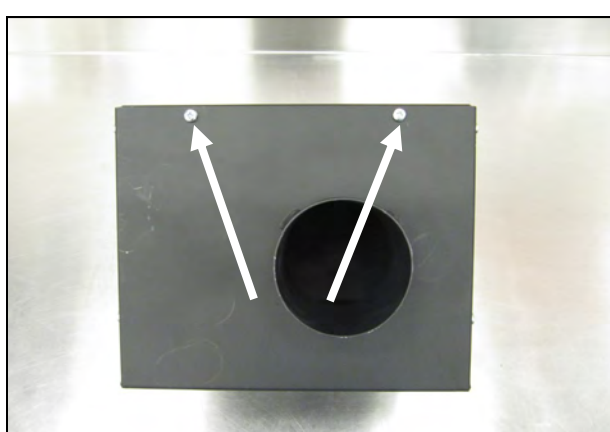

5. Use the two remaining Thread Cutting Screws on the bottom of the assembly shown.

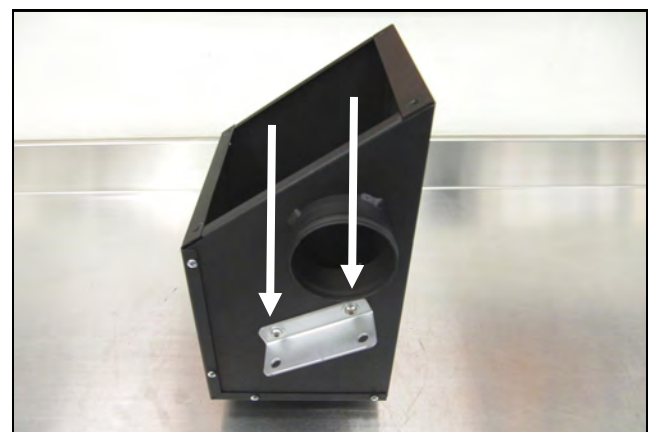

6. Install the Mounting Brackets (#7) onto both sides of the Airbox Assembly as shown using the four 1/4-20 x 1/4" Button Head Bolts (#14)

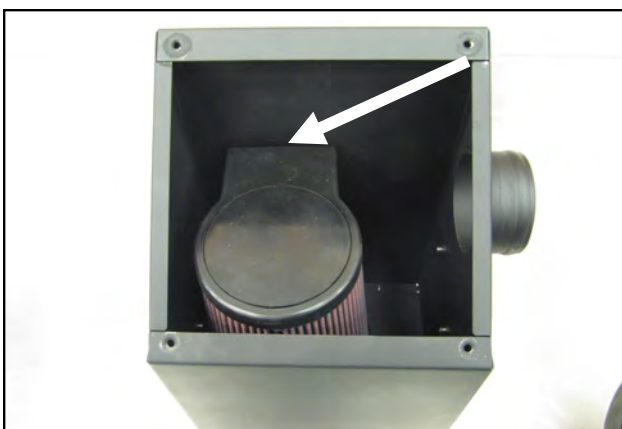

7. Slide the Airaid Premium Filter (#1) onto the mounting tube inside the Airbox Assembly. Note the location of the isolator tab on the filter inside of the box.

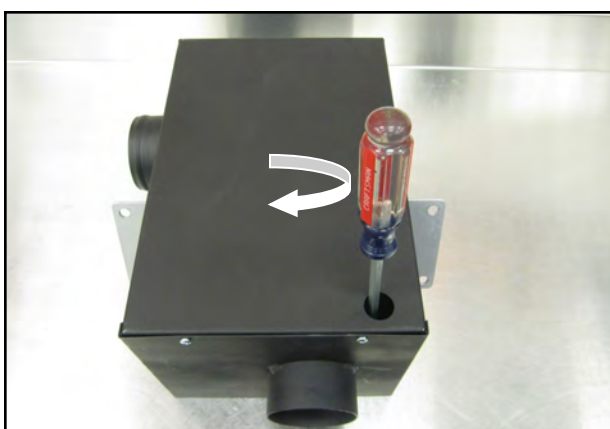

8. Tighten the Air Filter clamp through the access port on the back side of the Airbox.

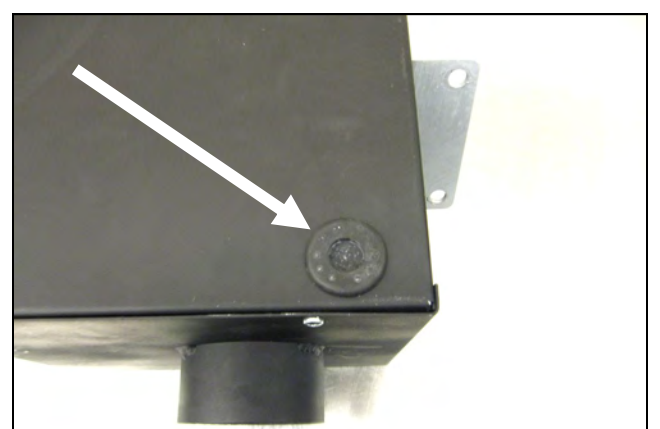

9. Install the Blind Grommet (#11) into the access port.



10. Install the Silicone Coupler (#8) and Two #48 Hose Clamps (#10) onto the factory intake tube. Leave the Clamps loose for now.

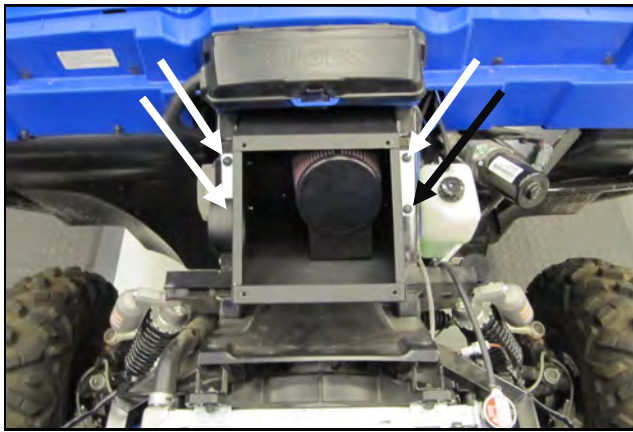

11. Insert the Airbox outlet into the Silicone coupler and tighten the Clamps. Mount the airbox to the vehicle by reusing the factory hardware from step one.

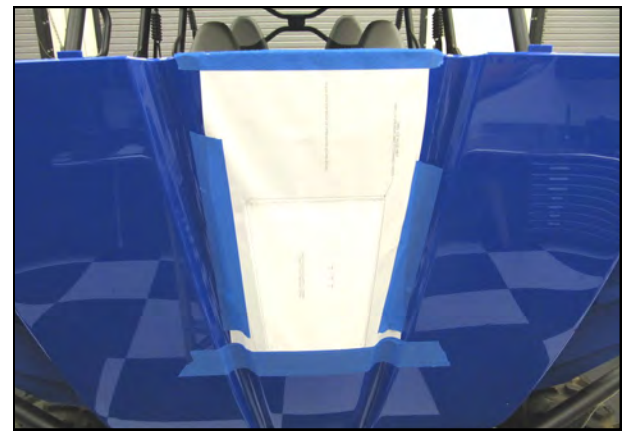

STOP ! If you have purchased the Snorkel kit PN 883-311 do not proceed to step 12. Refer to 883-311 instructions to complete installation.
12. Cut out the Template and carefully position it onto the vehicles hood. Tape the template in place.



13. Mark the hole locations in each corner using a center punch.



14. Using a 1/8" bit , drill out the punched holes on the hood. Finish the holes using a 1/2" bit or UniBit.



15. Using a jig saw, cut out the center section of the hood.



16. Install the Edge Trim (#16) onto the hood, trim to fit.

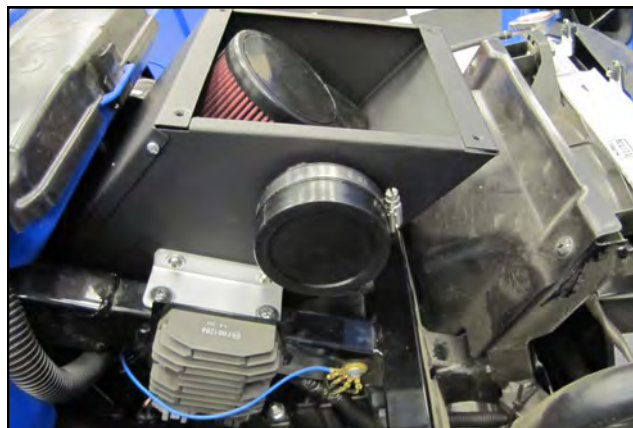

17. Install the Urethane Cap (#9) onto the Airbox Inlet tube and secure it using the third #48 Clamp.

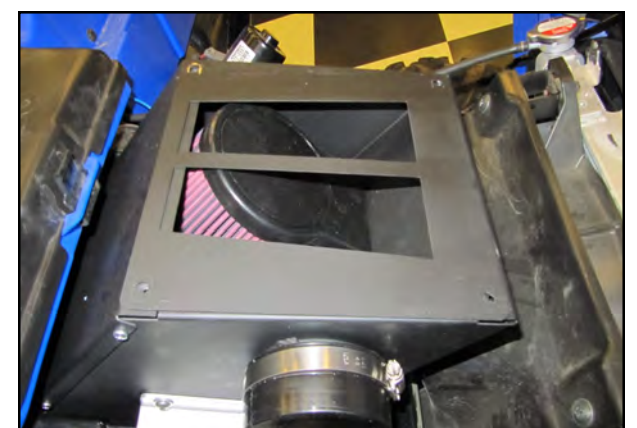

18. Place the Filter Tray (#4) onto the Air Box as shown.

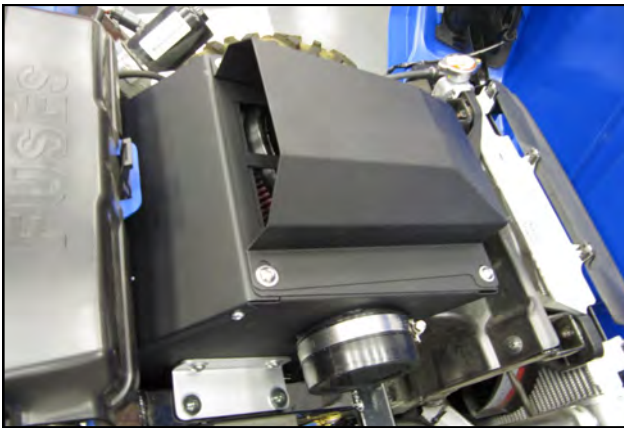

19. Install the Hood Scoop onto the Airbox Assembly using the four sets of 1/4-20 x 1/2" Button Head Bolts (#12) and 1/4" Flat Washers (#13). Leave the bolts loose for now to allow for final adjustment.



20. Insert the Foam Pre Filter (#6) into the Hood Scoop.



21. Lower the hood down onto the vehicle and secure it. Align the Hood Scoop from left to right inside of the cut out . Raise the hood, secure the Bolts and re connect the battery.

Thank you for purchasing the Airaid Intake System. Contact Airaid @ (800) 498-6951 8:00 AM - 5:00 PM MST weekdays for questions regarding fit or instructions that are not clear to you. Your Airaid Intake System was carefully inspected and packaged. Check that no parts are missing, or were damaged during shipping. If any parts are missing, contact Airaid. The air filter element is protected from direct exposure to water and debris; care should be taken not to drive through deep water. WATER INGESTION IS THE DRIVERS RESPONSIBILITY! The air filter is reusable and should be cleaned periodically.



For your Oiled media filter we suggest using the AIRAID Filter Tune-Up Kit!

**P/N 790-551 Aerosol Spray
P/N 790-550 Squeeze Spray**



ALIGN EDGE OF PAPER WITH TOP EDGE OF HOOD



ALIGN EDGE WITH BODY LINE

DRILL 1/2" HOLES FIRST
THEN CUT STRAIGHT LINES TO CONNECT HOLES

CHECK SIZE OF SQUARE TO CONFIRM
CORRECT SCALE BEFORE CUTTING

