



Installation Instructions

For Part Number:

883-315 Intake and Snorkel

2014-15 Kawasaki Teryx

2012-15 Kawasaki Teryx 4

750 cc

Component Identification

1.	Airaid Premium Filter	1
2.	Top Panel	1
3.	Bottom Panel	1
4.	Filter Tray	1
5.	Hood Scoop	1
6.	Foam Pre Filter	1
7.	Mounting Bracket	2
8.	Silicone Coupler	1
9.	Urethane Cap	1
10.	Airbox Lid	1
11.	Snorkel Tube	1
12.	Snorkel Inlet	1
13.	Snorkel Screen	1
14.	Foam Prefilter	1
15.	3" Flexible Duct, 40"	1
16.	48 Hose Clamp	4
17.	Blind Grommet	1
18.	1/4-20 x 1/2" Button Head screw	6
19.	1/4" Flat Washer	16
20.	1/4-20 x 1/4" Button Head screw	4
21.	#8-32 Thread Cutting Screw	10
22.	Edge Trim, 36"	1
23.	Edge Trim, 10"	1
24.	3" Loop Clamp	2
25.	1/4-20 Speed Nut	2
26.	1 3/4" Loop Clamp	3
27.	1/4-20 x 1 1/4" Bolt	3
28.	1/4-20 Nylock Nut	3
29.	8-32 x 3/8 Button Head Bolt	4
30.	Torx Screw	4
31.	T-20 Torx bit	1
32.	Bubble Sticker	1

Tools Required For Installation:

In addition to common hand tools, this installation requires the use of a : Hand drill, 1/2" Drill Bit, Jig Saw, Center punch, and hammer.

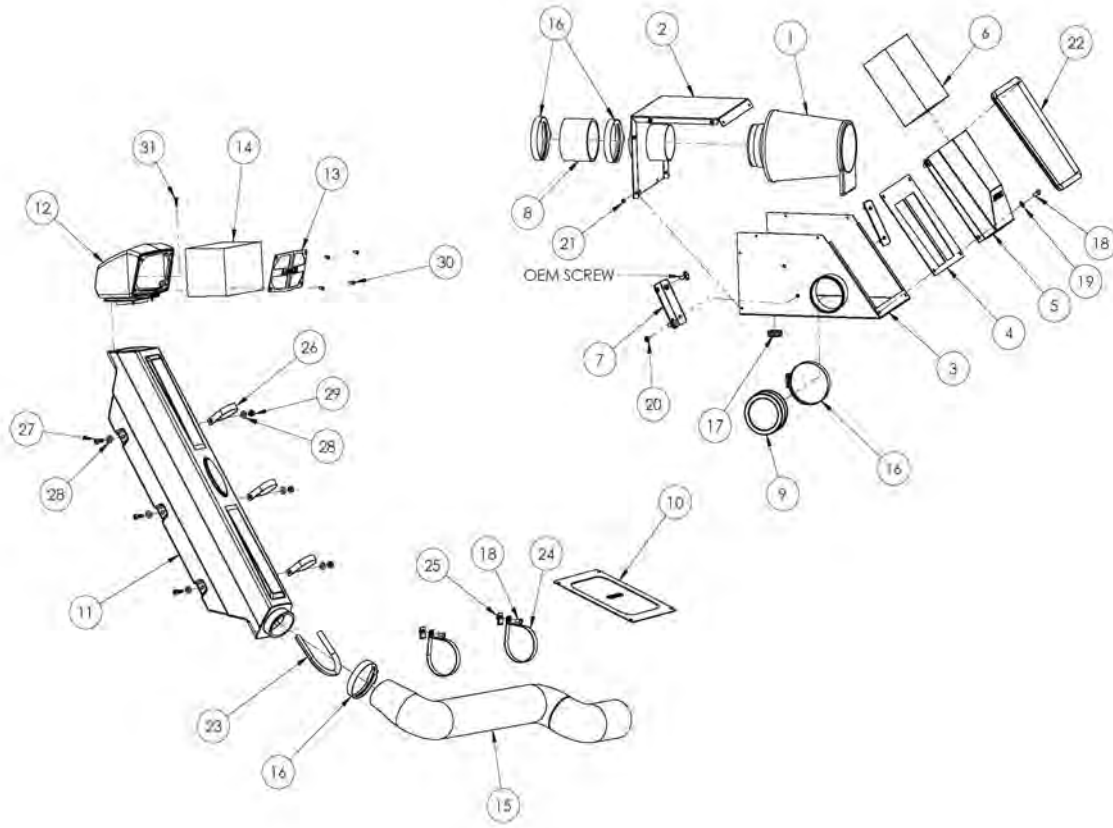

Full color instructions can be viewed on our web site at Airaid.com. Use the **Product Search** function to find your part number, and click **View Details**.

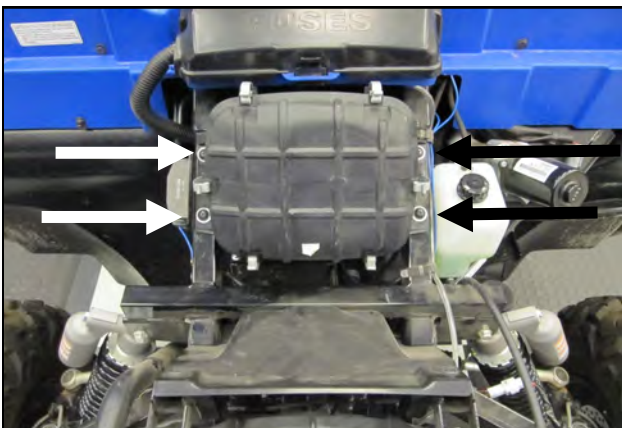

1. Raise the hood of the vehicle. Locate and disconnect the negative battery terminal underneath the airbox. Remove the four airbox bolts and set them aside. They will be reused in step 11.

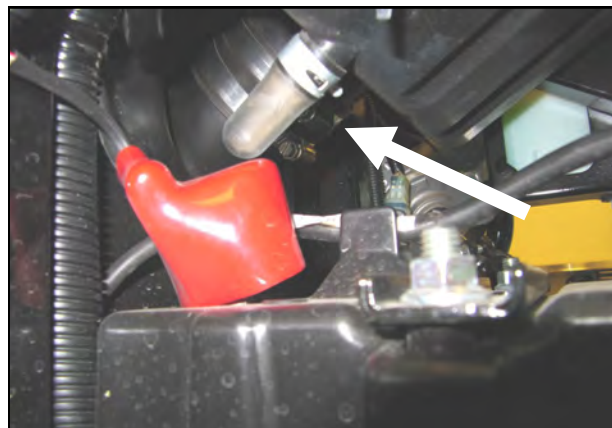

2. Loosen the clamps on the factory airbox couplers.



3. Remove the factory airbox and couplers from the vehicle.

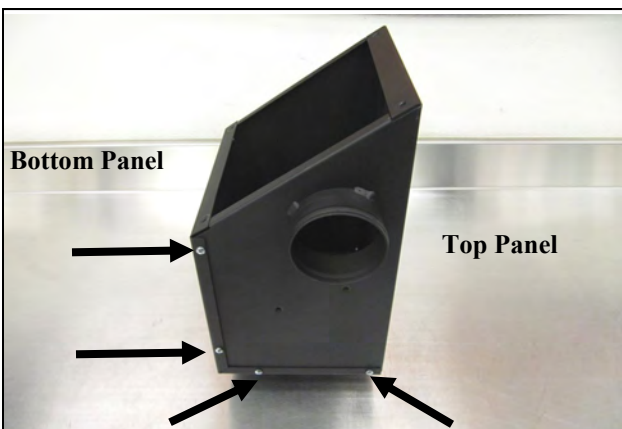

4. Create the Airbox Assembly by sliding the Top Panel (#2) into the Bottom Panel (#3). Use four of the 8-32 Thread Cutting Screws (#23) on each side to secure the panels.

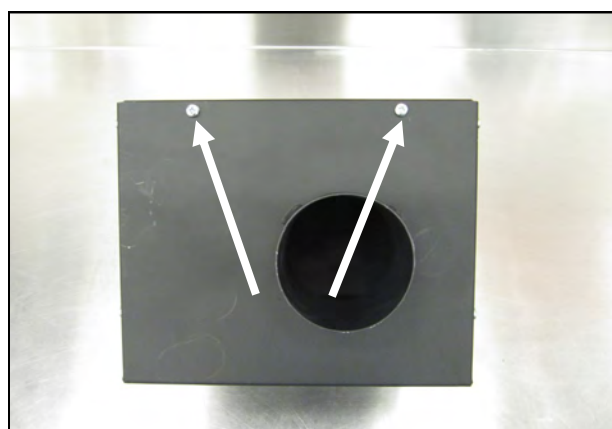

5. Use the two remaining Thread Cutting Screws on the bottom of the assembly shown.

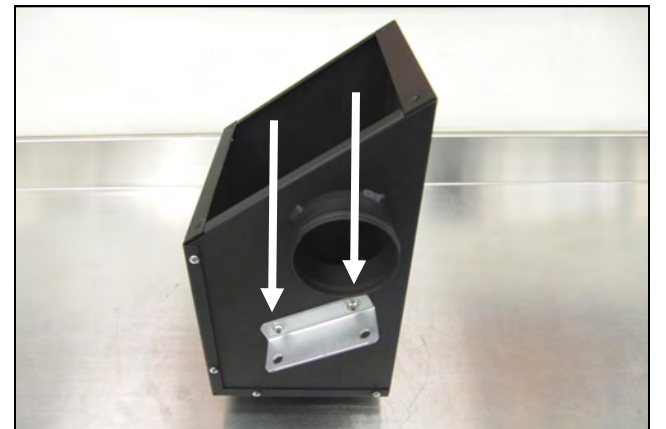

6. Install the Mounting Brackets (#7) onto both sides of the Airbox Assembly a shown using the four 1/4-20 x 1/4" Button Head Bolts (#22)

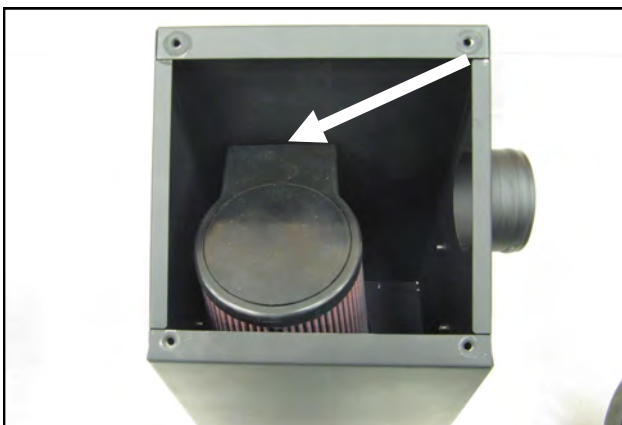

7. Slide the Airaid Premium Filter (#1) onto the mounting tube inside the Airbox Assembly. Note the location of the isolator tab on the filter inside of the box.

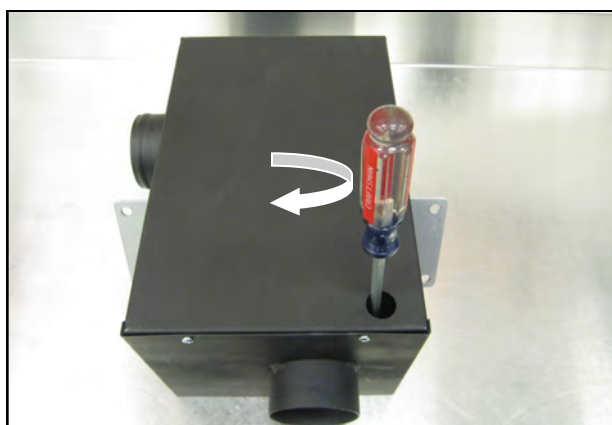

8. Tighten the Air Filter clamp through the access port on the back side of the Airbox.

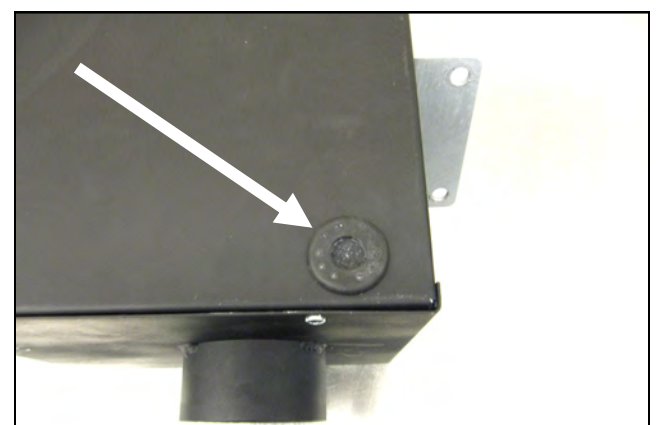

9. Install the Blind Grommet (#19) into the access port.



10. Install the Silicone Coupler (#8) and Two #48 Hose Clamps (#18) onto the factory intake tube. Leave the Clamps loose for now.

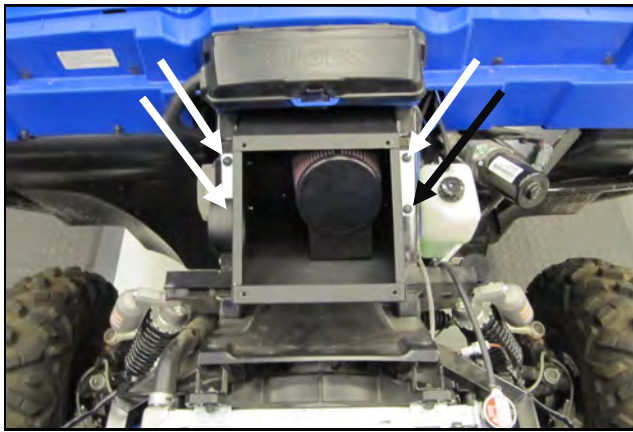

11. Insert the Airbox outlet into the Silicone coupler and tighten the Clamps. Mount the Airbox to the vehicle by reusing the factory hardware from step 1. **STOP! If you plan to install the Snorkel kit, proceed to step 22.**

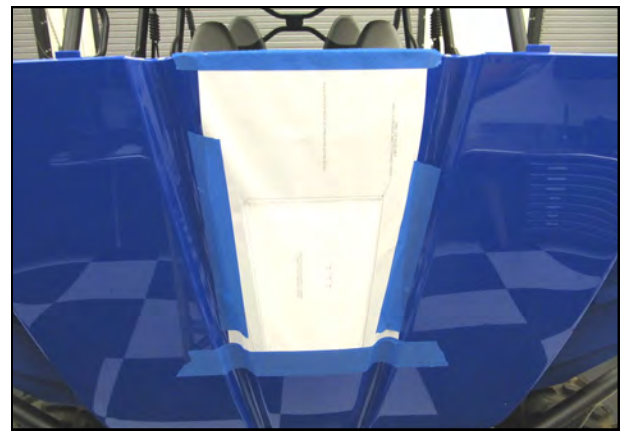

12. Cut out the Template and carefully position it onto the vehicles hood. Tape the template in place.



13. Mark the hole locations in each corner using a center punch.



14. Using a 1/8" bit , drill out the punched holes on the hood. Finish the holes using a 1/2" bit or UniBit.



15. Using a jig saw, cut out the center section of the hood.



16. Install the 36" Edge Trim (#21) onto the hood, trim to fit.

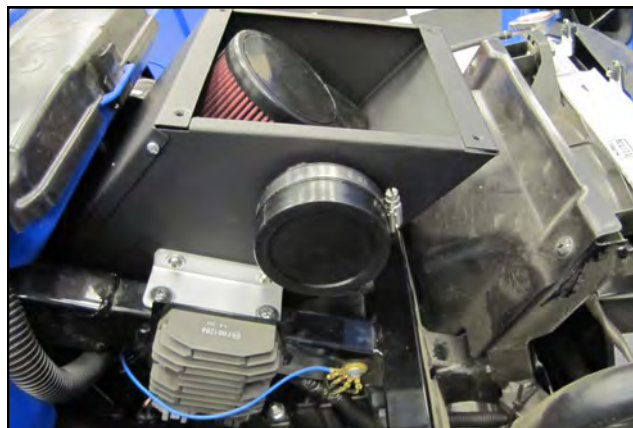

17. Install the Urethane Cap (#9) onto the Airbox Inlet tube and secure it using the third #48 Clamp.

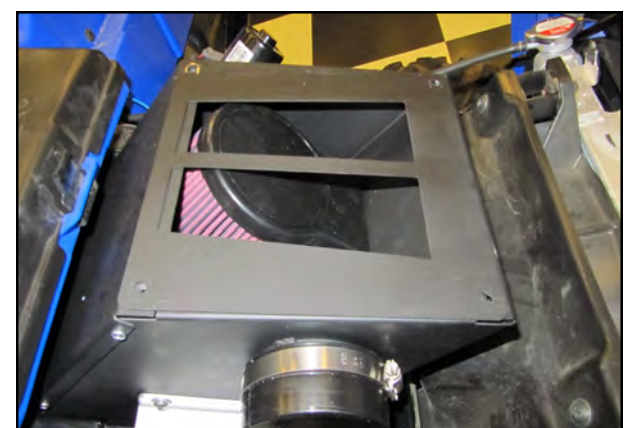

18. Place the Filter Tray (#4) onto the Air Box as shown.

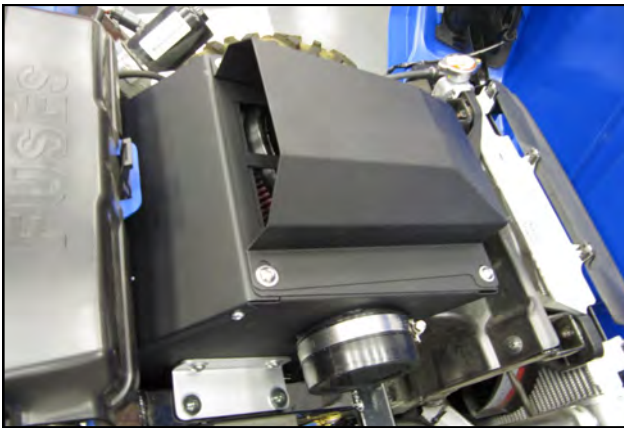

19. Install the Hood Scoop onto the Airbox Assembly using the four sets of 1/4-20 x 1/2" Button Head Bolts (#20) and 1/4" Flat Washers (#21). Leave the bolts loose for now to allow for final adjustment.



20. Insert the Foam Pre Filter (#6) into the Hood Scoop.



21. Lower the hood down onto the vehicle and secure it. Align the Hood Scoop from left to right inside of the cut out . Raise the hood, secure the Bolts and re connect the battery.



22. Install the Airbox Lid (#1) onto the Airaid performance Airbox using The four 1/4-20 x 1/2" Button Heads Bolts and 1/4" Flat Washers from the Airaid 883-306 intake.



23. Side the three small Loop Clamps (#26) onto the roll cage A pillar as shown.



24. Mount the Snorkel Inlet(#13) to the Snorkel Tube (#12), using the four Torx screws (#33), Torx Bit #18 and a 90deg. Low Profile Ratcheting Screwdriver.



25. Carefully insert the Airaid Foam Prefilter (#6) into the Snorkel Inlet.



26. Install the Snorkel Screen (#14) onto the Inlet using the four 8-32 Button Head Screws(#29).



27. Attach the Snorkel Tube to the Loop Clamps using three 1/4-20 x 1 1/4 Bolts (#27), 1/4-20 Locknuts (#28), and Flat washers (#21). Leave all hardware finger tight at this time to allow for proper alignment

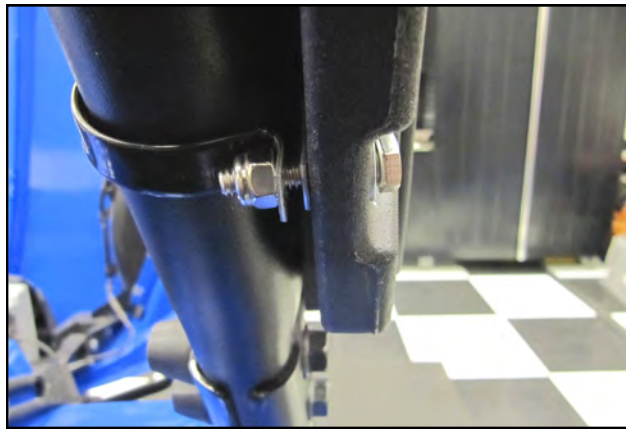

28. Close up of proper Snorkel hardware orientation.

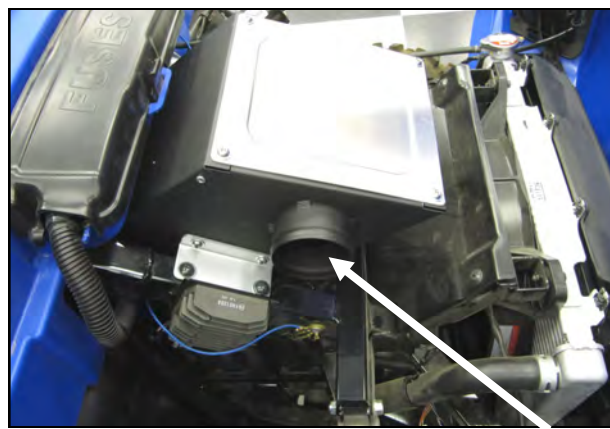

29. Remove the Urethane Cap from the Airaid performance Airbox if it has previously been installed. The Clamp will be reused in step 34.

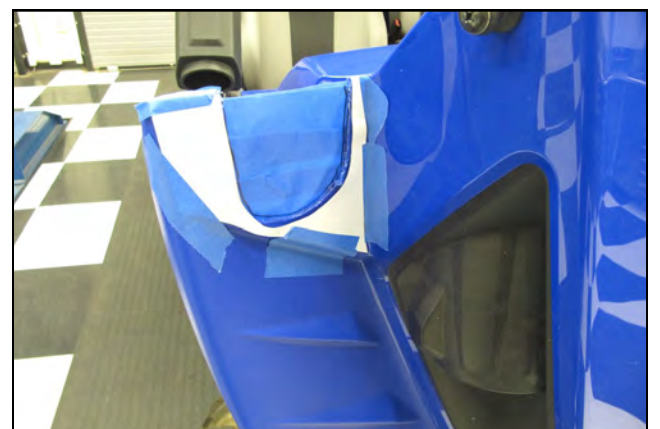

30. Install Cut out the fender Template and tape it in position on the corner of the passenger side hood as shown.



31. Using a jig saw or equivalent, follow the template and cut out the Duct relief.

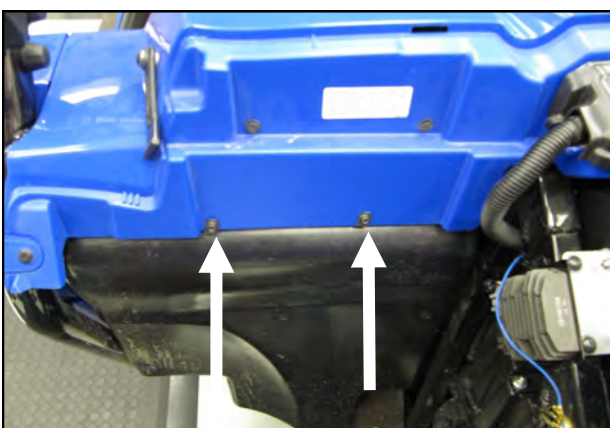

32. Install Slide the Speed Nuts (#25) onto the Cowl plastic with the threaded side out.

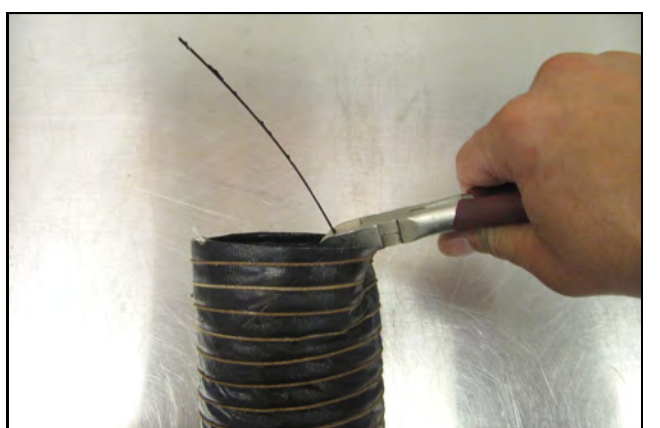

33. Using a pair of dykes, pull out approximately three windings of the steel wire inside of the Ducting (#16) and cut it off.

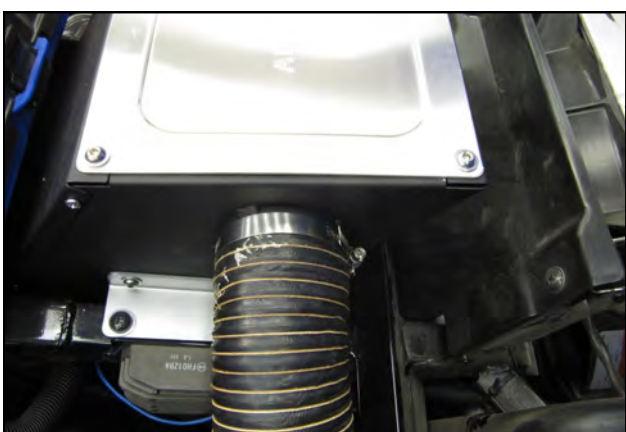

34. Install the Flexible Duct onto the Airaid performance airbox as shown using a # 48 Clamp.



35. Install the other end of the Ducting onto the Snorkel tube using the last #48 Hose Clamp (#18).



36. Full view of Duct routing.

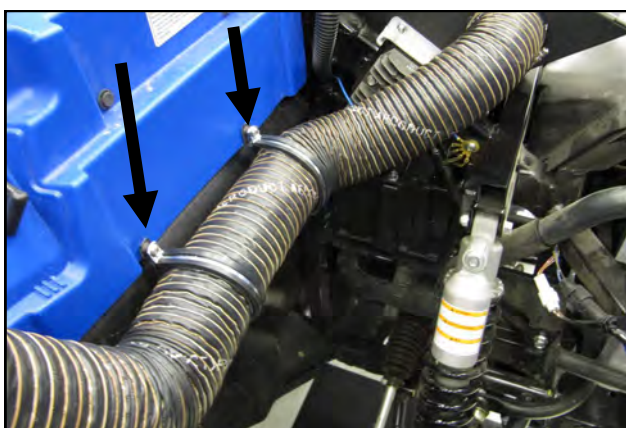

37. Mount the duct to the Speed Nuts on the bulkhead using the two 3" Loop Clamps (#26) and 1/4-20 x 1/2" button Head Bolts (#20).



38. Slide the 10" Edge Trim (#25) over the cut out on the Hood.



39. Align the Snorkel and Ducting and verify the opening and closing action of the hood is not adversely effected. Tighten all of the Clamp bolts when done.



40. Double check all of your work and re connect the battery.



Thank you for purchasing the Airaid Intake System. Contact Airaid @ (800) 498-6951 8:00 AM - 5:00 PM MST weekdays for questions regarding fit or instructions that are not clear to you. Your Airaid Intake System was carefully inspected and packaged. Check that no parts are missing, or were damaged during shipping. If any parts are missing, contact Airaid. The air filter element is protected from direct exposure to water and debris; care should be taken not to drive through deep water. WATER INGESTION IS THE DRIVERS RESPONSIBILITY! The air filter is reusable and should be cleaned periodically.

For your Oiled media filter we suggest using the AIRAID Filter Tune-Up Kit!



P/N 790-551 Aerosol Spray
P/N 790-550 Squeeze Spray

The Premium Cleaning Kit for your Premium Airaid Filter...

- Clean your Airaid filter
- Restore full airflow efficiency
- Maintain optimum engine performance



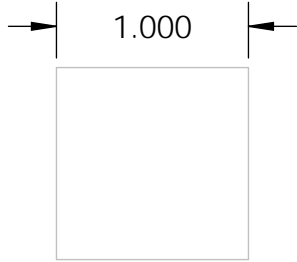
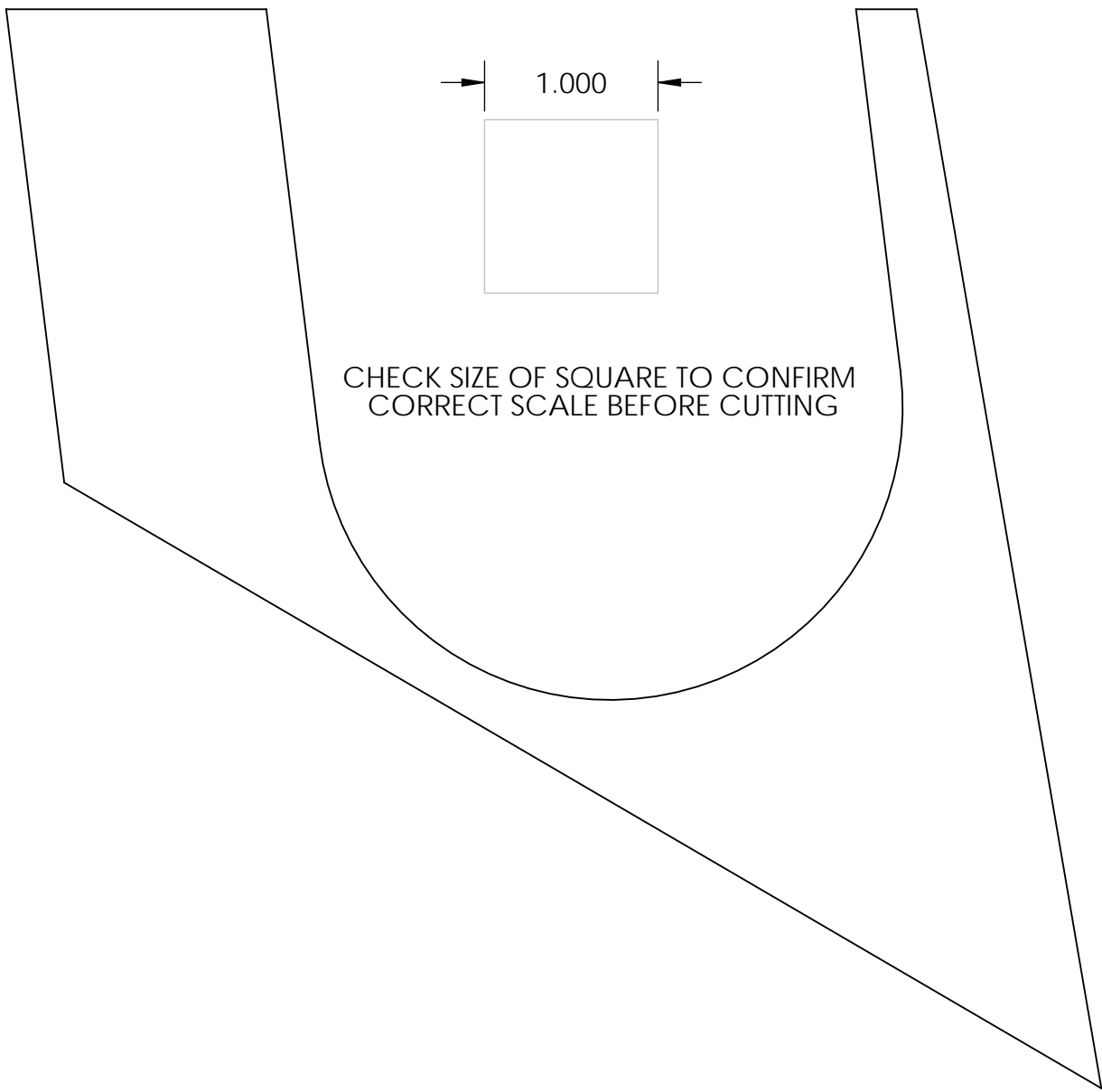

CHECK SIZE OF SQUARE TO CONFIRM
CORRECT SCALE BEFORE CUTTING

ALIGN EDGE OF PAPER WITH TOP EDGE OF HOOD



ALIGN EDGE WITH BODY LINE

DRILL 1/2" HOLES FIRST
THEN CUT STRAIGHT LINES TO CONNECT HOLES

CHECK SIZE OF SQUARE TO CONFIRM
CORRECT SCALE BEFORE CUTTING

