

INSTALLATION INSTRUCTIONS

2010-12 GMC TERRAIN / 2010-12 CHEVY EQUINOX

PART NUMBER # 4551

PARTS LIST:

Qty	Description	Qty	Description
1	Sport Bar	10	12mm x 32mm OD x 3mm Flat Washers
1	Driver side/Left Frame Bracket	6	12mm Lock Washers
1	Passenger side/Right Frame Bracket	6	12mm Hex Nuts
1	Driver side/Left Support Bracket	4	10-1.5mm x 35mm Hex Bolts
1	Passenger side/Right Support Bracket	8	10mm x 27mm x 3mm Flat Washers
2	12mm x 40mm Special Bolt Plates	4	10mm Lock Washers
2	12-1.75mm x 35mm Hex Bolts	4	10mm Hex Nuts
2	12-1.75mm x 40mm Hex Bolts		

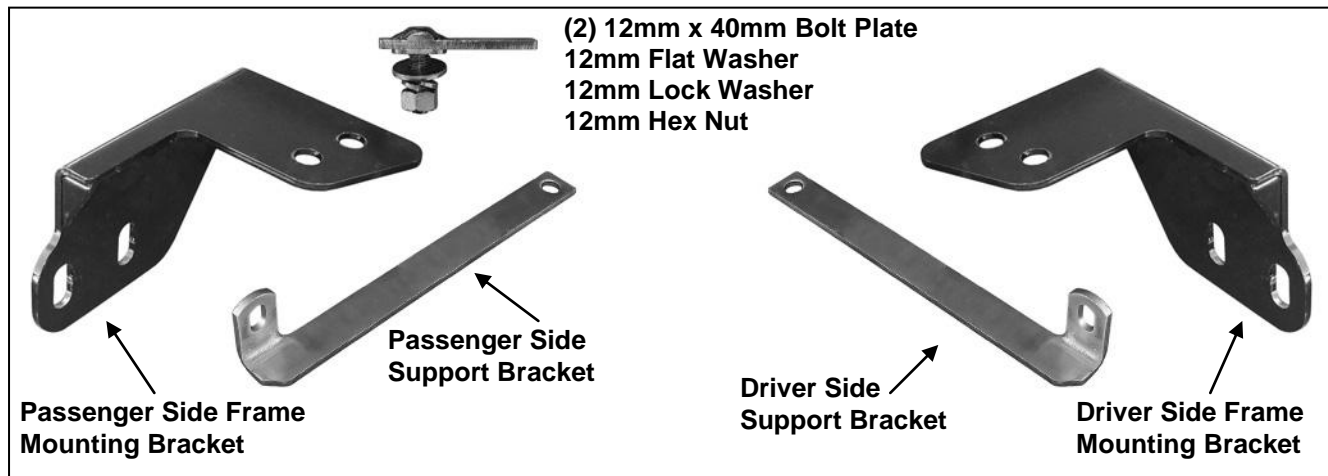

PROCEDURE:

1. REMOVE CONTENTS FROM BOX. VERIFY ALL PARTS ARE PRESENT. READ INSTRUCTIONS CAREFULLY BEFORE STARTING INSTALLATION. ASSISTANCE IS RECOMMENDED. CUTTING IS REQUIRED
2. Remove the plastic front air dam/lower bumper cover. **NOTE:** From behind the bumper, locate and remove the screws holding the air dam to the ends of the bumper cover, (**Fig 1**). Remove the factory plastic clips securing the air dam at the fender well. Once all screws and clips have been removed, hold the bumper cover in place and firmly pull the lower cover/air dam to release clips and separate the air dam from the bumper cover.
3. Select the driver side Mounting Bracket. Insert the Bracket above the factory radiator bracket and line up the (2) holes, (**Fig 2**), with the holes in the factory bracket. Secure the Mounting Bracket to the radiator bracket with (2) 10mm x 35mm Hex Bolts, (4) 10mm Flat Washers, (2) 10mm Lock Washers and (2) 10mm Hex Nuts. Snug but do not tighten hardware at this time. Repeat this Step for passenger side Mounting Bracket installation.
4. Insert (1) 12mm Bolt Plate into the slot in the bottom of the frame, (**Fig 3**). Center the Bolt Plate in the oval hole. Attach the flat end of the driver side Support Bracket to the Bolt Plate with (1) 12mm Flat Washer, (1) 12mm Lock Washer and (1) 12mm Hex Nut, (**Fig 4**). Repeat this Step for passenger side Support Bracket installation. Do not tighten hardware at this time.

5. With assistance, hold the Sport Bar up to the inside of the (2) Mounting Brackets. Line up the mounting holes and insert the longer (2) 12mm x 40mm Hex Bolts with (2) 12mm Flat Washers through the (2) rear mounting holes on the Mounting Brackets, the Sport Bar and through the Support Brackets, **(Fig's 4 & 5)**. Secure the hex bolt with (2) 12mm Flat Washers, (2) 12mm Lock Washers and (2) 12mm Hex Nuts. Use the (2) shorter 12mm x 35mm Hex Bolts, (4) 12mm Flat Washers, (2) 12mm Lock Washers and (2) 12mm Hex Nuts on the (2) forward mounting holes, **(Fig 4)**.
6. Center and align the Sport Bar. Once absolutely satisfied with the fit and alignment, tighten the 10mm hardware securing the Frame Mounting Brackets to the radiator brackets. Remove the Sport Bar.
7. Temporarily reinstall the air dam. Find the center of the spoiler by locating the molding ID mark on the back-center of the spoiler, **(Fig 6)**. Measure outward from the center mark to the inside of the driver side and passenger side mounting brackets to verify that the Sport Bar is centered on the vehicle, **(Fig's 7 & 8)**. This measurement will be the centerline of the slots to cut through the spoiler.
8. Use a felt marker or paint pen to mark a vertical line representing both mounting bracket locations onto the back of the plastic spoiler, **(Fig 7)**, with top and bottom of Bracket indicated. Remove the spoiler and place it on a clean, stable work surface. Measure from the center of the spoiler, (ID mark), outward the distance measured in **Step 7, (Fig 8)**. Use the previously marked line for a vertical reference and draw a parallel line at the measured distance, **(Step 9)**. **NOTE:** Check all measurements before continuing.
9. Drill a 1/2" hole at the top and the bottom of the measured line, **(Fig 10)**. Use a sharp utility knife or hacksaw to cut a 1/2" wide slot for the Mounting Brackets, **(Fig 11)**. **NOTE:** Additional trimming for Sport Bar clearance may be required on Equinox model vehicles. **IMPORTANT:** To maintain the integrity of the spoiler, do not cut completely through the top or bottom edge of the spoiler. Only remove material required to clear the Sport Bar.
10. Reinstall the spoiler using the factory hardware and clips. Hold the Sport Bar up in position to check for clearance. Trim plastic as necessary.
11. Insert the Sport Bar through the air dam and bolt it to the Mounting Brackets with the hardware listed in **Step 5, (Fig 12)**.
12. Level and adjust Sport Bar properly and tighten all hardware.
13. Do periodic inspections to the installation to make sure that all hardware is secure and tight.

To protect your investment, wax this product after installing. Regular waxing is recommended to add a protective layer over the finish. Do not use any type of polish or wax that may contain abrasives that could damage the finish.

For stainless steel: Aluminum polish may be used to polish small scratches and scuffs on the finish. Mild soap may be used also to clean the Sport Bar.

For gloss black finishes: Mild soap may be used to clean the Sport Bar.

Driver Side Mounting Bracket Installation Pictured

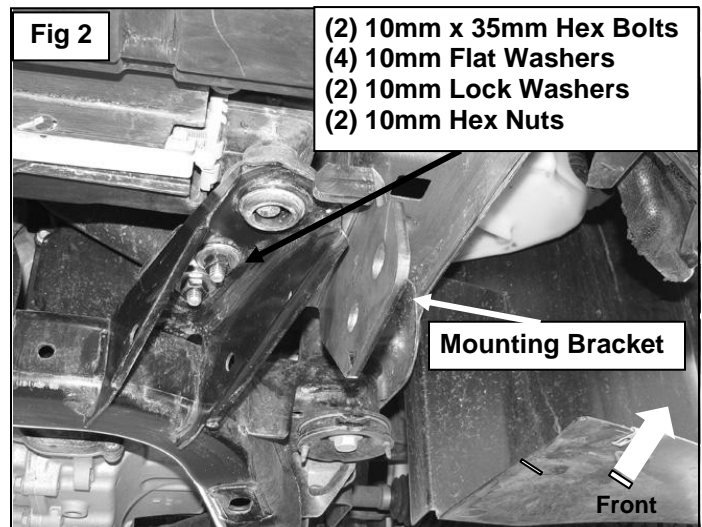
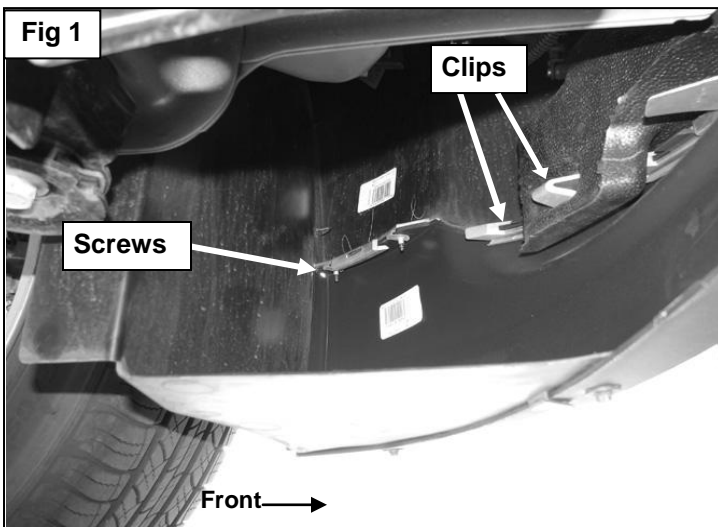

Driver Side Installation Pictured

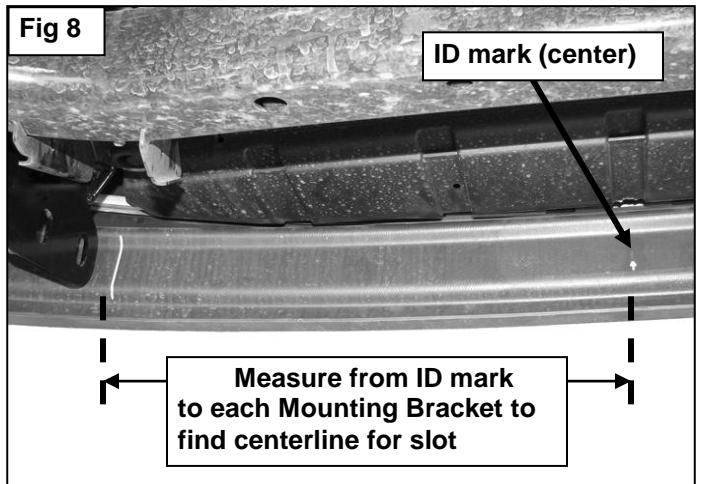
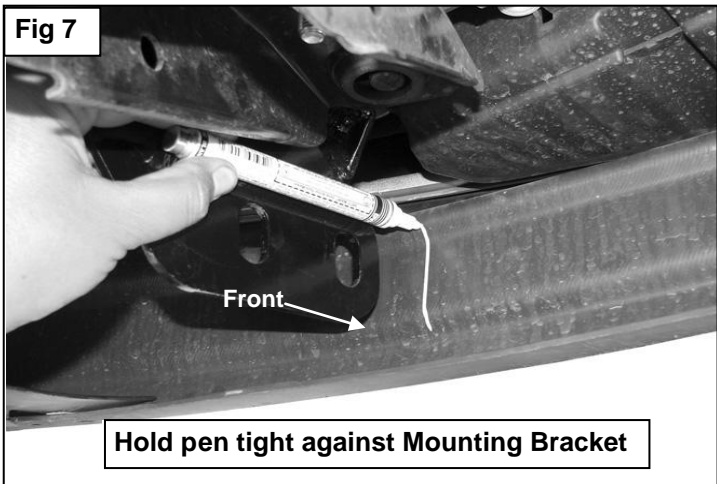
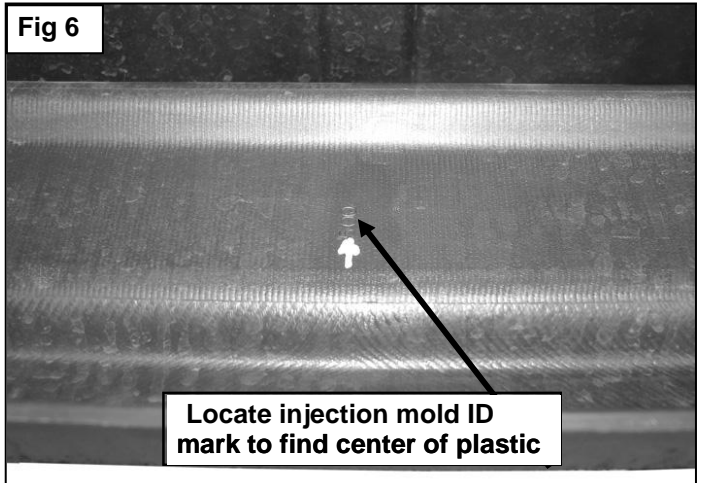
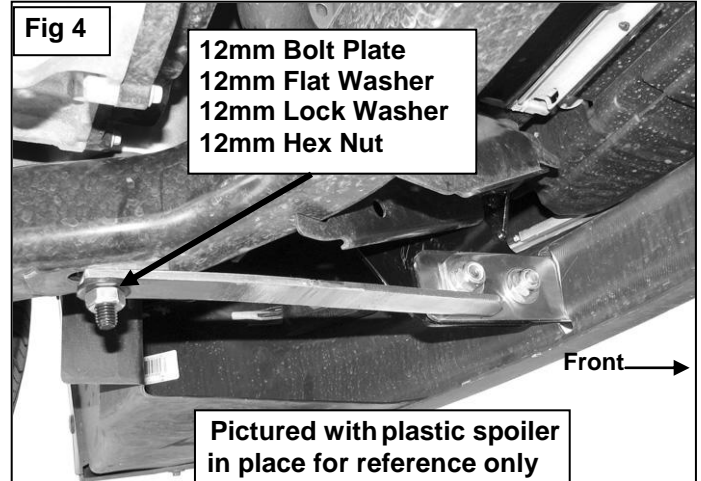
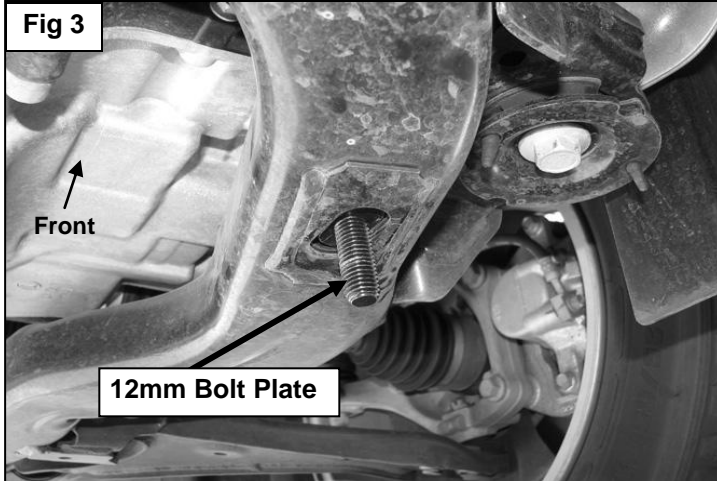

Driver Side Installation Pictured

