

***Discharging & Recharging of the A/C System is required for this install.***



**INTERCOOLER INSTALLATION**  
**FOR 2010+ DODGE 6.7L CUMMINS**

Application List		
2010+	6.7L Cummins	1042530

**PLEASE READ ALL INSTRUCTIONS BEFORE INSTALLATION**

**UNLESS AN EO# IS LISTED, THIS PRODUCT IS LEGAL IN CALIFORNIA FOR RACING VEHICLES ONLY, WHICH MAY NEVER BE USED UPON A HIGHWAY.**

# KIT CONTENTS:

Please check to make sure that you have all the parts listed in this kit **before** you start the disassembly of your truck.

1402530	1453320	1401569	1300131
<i>Charge Air Cooler (CAC)</i>	<i>(DS) Intercooler Boot</i>	<i>(PS) Intercooler Boot</i>	<i>Cable Ties</i>
<b>Qty: 1</b>	<b>Qty: 1</b>	<b>Qty: 1</b>	<b>Qty: 4</b>

1900037	1900056	1405209	1405211	1405212	1407030
<i>Flange Bolt (12mm)</i>	<i>Flange Bolt (25mm)</i>	<i>(300) CLAMP</i>	<i>(325) CLAMP</i>	<i>(378) CLAMP</i>	<i>(350) CLAMP</i>
<b>Qty: 4</b>	<b>Qty: 2</b>	<b>Qty: 1</b>	<b>Qty: 1</b>	<b>Qty: 1</b>	<b>Qty: 1</b>

## ***Tools Required***

- A/C Machine
- Metric Socket Set
- Push Pin Removal Tool
- Metric Wrench Set

## ***Options***

### **Description**

6.7L Super B Special Turbo  
Line Pressure Booster  
68RFE Transmission

### **Part #**

1045140  
1030368  
Call for Details

BD Engine Brake Inc.

Plant Address: 33541 MacLure Rd. Abbotsford, BC, Canada V2S 7W2

U.S. Shipping Address: 88-446 Harrison St, Sumas, WA 98295 U.S. Mailing Address: P.O. Box 231, Sumas, WA 98295

Phone: 604-853-6096 | Fax: 604-853-8749 | Internet: www.bd-power.com

## Removal

1. Block wheels, Record radio settings, disconnect negative battery terminals (8mm) and recover A/C refrigerant using an A/C machine.

2. Use a push pin removal tool to remove the radiator support to grill cover.

3. Remove the grill, 4 (10mm) bolts on top, then release clips from lower section and remove from vehicle.

4. Under vehicle remove 4 push pins from bottom of radiator shroud to loosen lower cover and disconnect fog light harness at left side of bumper.



5. Remove 4 (18mm) nuts on each bumper mount and lift bumper off of vehicle.

6. Mark bumper bracket position on frame using a paint pen and remove 2 (18mm) nuts on either bracket.

7. Remove 1 (13mm) nut for A/C lines at condenser and move lines out of the way.

8. Remove the (10mm) bolt that holds the transmission lines to Charge Air Cooler (CAC) on driver's side, then remove E clips from fittings and pull lines out of the way. ( Cap lines to reduce oil leaking )

9. Remove 4 (10mm) bolts securing A/C –Transmission Cooler to CAC and lift from vehicle.

10. Disconnect MAF and IAT sensors on air box lid and place out of way. Disconnect air inlet tube at air box. Remove 1 (10mm) nut securing air box to radiator support and lift box from vehicle.

11. Loosen CAC clamps (11mm) at CAC , turbo and intake horn. Remove CAC pipes from vehicle.

12. Remove 2 (13mm) bolts securing the CAC to the radiator support.

13. Lift CAC up and slightly forward resting lower mounts on top of the cross member, remove the bumper bracket bolts and brackets. Lift Charge Air Cooler (CAC) from

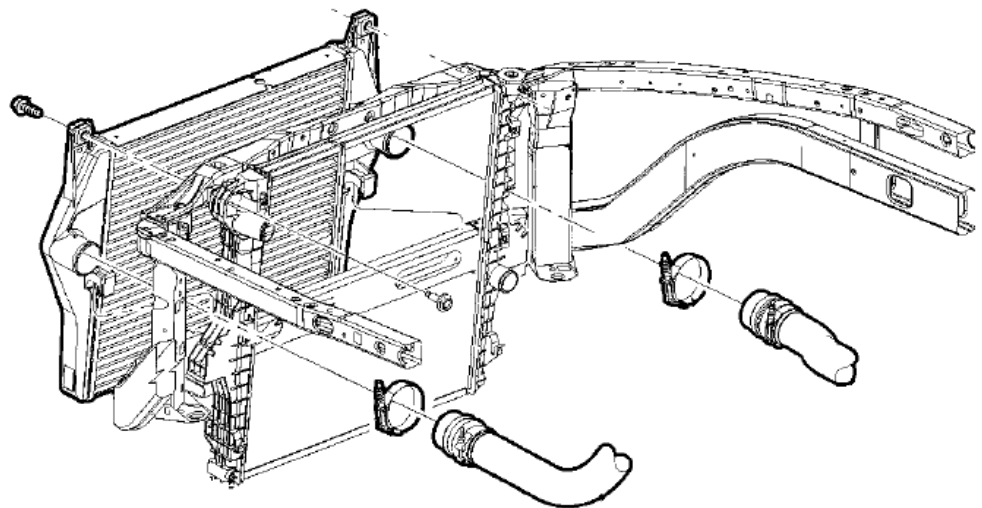

BD Engine Brake Inc.

Plant Address: 33541 MacLure Rd. Abbotsford, BC, Canada V2S 7W2

U.S. Shipping Address: 88-446 Harrison St, Sumas, WA 98295 U.S. Mailing Address: P.O. Box 231, Sumas, WA 98295

Phone: 604-853-6096 | Fax: 604-853-8749 | Internet: www.bd-power.com



vehicle.

**Installation**

14. Swap upper and lower rubber mounts from Original Equipment (OE) Charge Air Cooler to BD Charge Air Cooler.

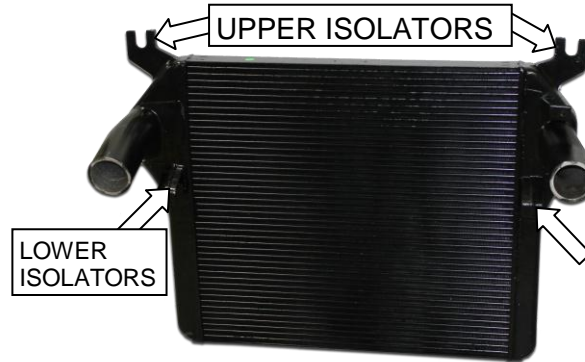

15. Remove foam pieces from lower section of radiator on both sides. Trim 7/8" in a straight line off both lower tabs on the radiator tanks and deburr.

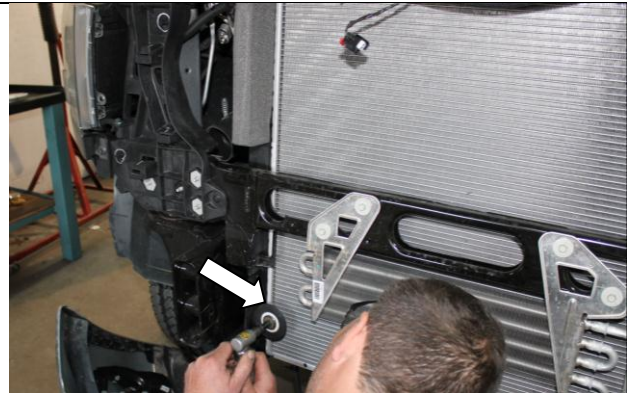

16. Lift BD CAC onto top of cross member and reinstall bumper brackets loosely with bolts and nuts.

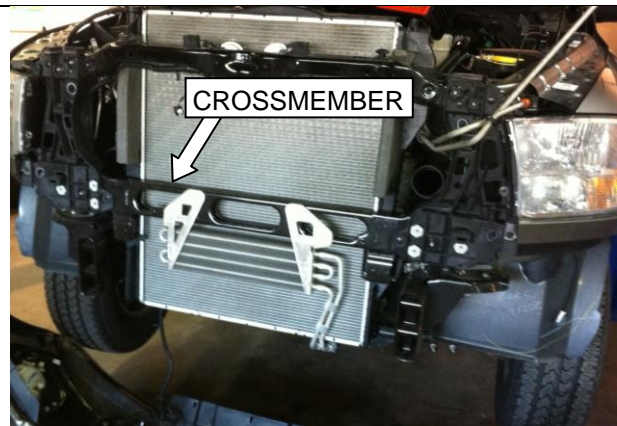

17. Lower BD CAC onto cross member in original mounting location and tilt top to radiator support. Reinstall 2 (10mm) bolts from OE.



BD Engine Brake Inc.

Plant Address: 33541 MacLure Rd. Abbotsford, BC, Canada V2S 7W2

U.S. Shipping Address: 88-446 Harrison St, Sumas, WA 98295 U.S. Mailing Address: P.O. Box 231, Sumas, WA 98295

Phone: 604-853-6096 | Fax: 604-853-8749 | Internet: www.bd-power.com

18. Carefully cut crimped clamps off of OE CAC pipes at **CAC end only** and remove boots.

**2010 6.7L Installation Note**

On 2010 6.7L vehicles you will notice that the factory silicone intercooler boots are permanently connected to the CAC inlet and outlet tubes. You will need to cut off the swaged pinch ring with a cut off wheel. Be sure not to damage the inlet and outlet pipe in the process.

Once the pinch ring has been cut you can slide off the OE boot and insert the supplied silicone boot and clamp. Torque to 50 in/lbs on plastic pipe. On the steel pipe tighten until spring is bound. **DO NOT OVER TIGHTEN NEW CLAMP ON THE PLASTIC PIPE AS IT MAY DEFORM THE PIPE CAUSING A LEAK.**

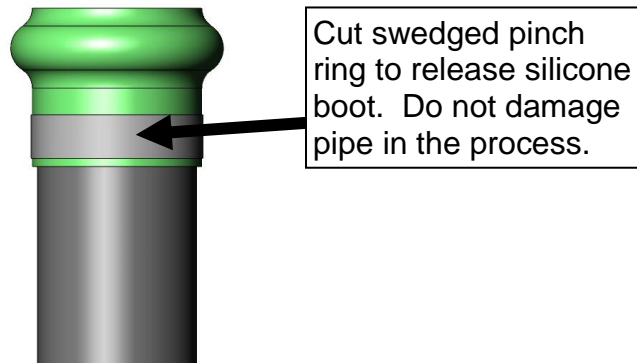

19. Install provided boots and clamps (13mm) on to BD CAC and tighten until spring bound.

20. Reinstall driver side CAC pipe using provided clamp at CAC end only and tighten clamps until spring bound (11mm & 13mm). OE clamp is required for connection to intake.

21. Reinstall passenger side CAC pipe using provided clamp at CAC end and tighten until spring bound (11mm & 13mm). OE clamp is required for connection to turbo.

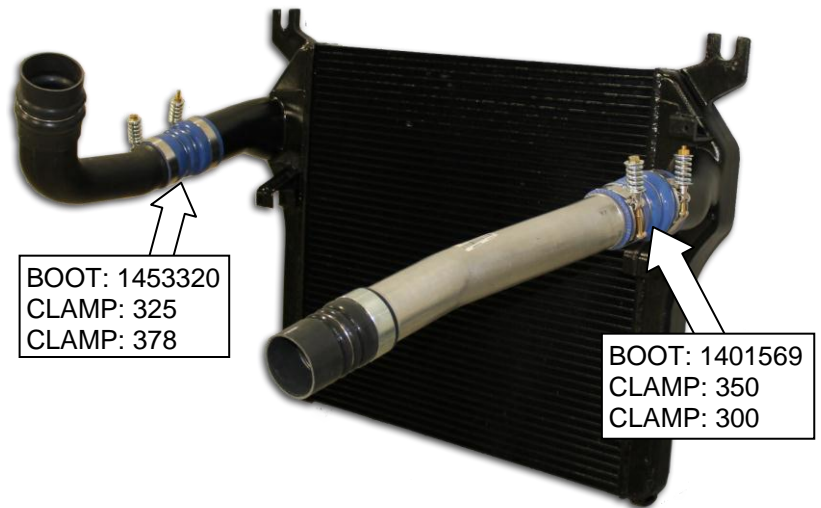

22. Reinstall air box. Mount to radiator support with OE nut (10mm), connect air intake tube (8mm) and connect MAF and IAT sensors.
23. Mount A/C- Transmission Cooler assembly to BD CAC using provided bolts (10mm) and reuse OE large washers on driver side.
24. Connect A/C lines using OE nut (13mm).
25. Reinstall bumper using OE nuts (18mm). Connect fog lights at driver side. Lower cover will have to be arranged under BD CAC which sits lower than the OE CAC. Push pin holes will not line up with radiator shroud, zip ties may be used to secure cover if necessary.
26. Remove bolt (10mm) and bracket from transmission cooler lines. Upper transmission cooler line will have to be realigned to clear the grill and bracket will have to be trimmed. Change bends on upper transmission cooler line to move away from grill and connect to cooler. Trim bracket to allow clearance and reinstall with OE bolt (10mm).



27. Reinstall grill using OE bolts (10mm). Check clearance to transmission cooler lines again.



28. Reinstall top cover with OE push pins.
29. Recharge A/C with refrigerant.
30. Reconnect negative battery terminals (8mm).

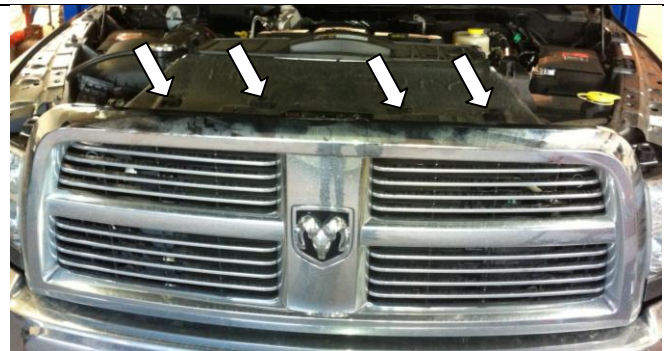

31. Idle vehicle and check transmission fluid level.
32. Road test and check over.

BD Engine Brake Inc.

Plant Address: 33541 MacLure Rd. Abbotsford, BC, Canada V2S 7W2

U.S. Shipping Address: 88-446 Harrison St, Sumas, WA 98295 U.S. Mailing Address: P.O. Box 231, Sumas, WA 98295

Phone: 604-853-6096 | Fax: 604-853-8749 | Internet: www.bd-power.com