



# 11170 INSTALLATION INSTRUCTIONS



Safety glasses should be worn at all times while installing this product.

YEARS: 2008-CURRENT

MAKE: MINI COOPER

MODEL: CLUBMAN & CLUBMAN S, INCLUDING JOHN COOPER WORKS

STYLE: COMPACT

**WARNING: NEVER EXCEED YOUR VEHICLE MANUFACTURER'S RECOMMENDED TOWING CAPACITY**

**WEIGHT CARRYING:**  
TRAILER WEIGHT: 2,000 LBS.  
TONGUE WEIGHT: 200 LBS.

**WARNING:**  
WE STRONGLY RECOMMEND THE USE OF AUXILIARY STABILIZING STRAPS FOR ALL NON-TRAILER (WHEEL-LESS) LOADS. PLEASE SEE THE CURT CATALOG OR VISIT US ONLINE AT [WWW.CURTMFG.COM](http://WWW.CURTMFG.COM) FOR FURTHER INFORMATION.

**INSTALLATION TIME: 60 MIN.**

THE INSTALL TIME LISTED IS FOR PROFESSIONAL INSTALLERS. IF YOU ARE HESITANT TO UNDERTAKE THIS TASK ON YOUR OWN, CONTACT AN AUTHORIZED CURT INSTALLER FOR ADDITIONAL ASSISTANCE.



### INSTALLATION REQUIRES:

 RATCHET	 TORQUE WRENCH	 9" SOCKET EXTENSION
 13mm SOCKET	 SCREW DRIVER	 POWER DRILL
 HOLE SAW 2-1/2"	 OFFSET SCREWDRIVER	

### INSTALLATION TIPS:

- BEFORE YOU BEGIN INSTALLATION, READ ALL INSTRUCTIONS THOROUGHLY.
- TO EASE INSTALLATION, 2 PEOPLE MAY BE REQUIRED.
- USING PROPER TOOLS WILL GREATLY IMPROVE THE QUALITY OF THE INSTALL AND REDUCE THE TIME REQUIRED.
- NEED HELP OR HAVE SOME QUESTIONS? CALL TECHNICAL SUPPORT AT 800.798.0813

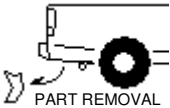
### LEVEL OF DIFFICULTY: HARD

EASY	MODERATE	HARD
 PART REMOVAL	MUST REMOVE BUMPER COVER AND BUMPER BEAM	
 TRIM	DRILL BUMPER COVER	

### VEHICLE PHOTO:



REPRESENTATIVE PHOTO

### HITCH ILLUSTRATION:

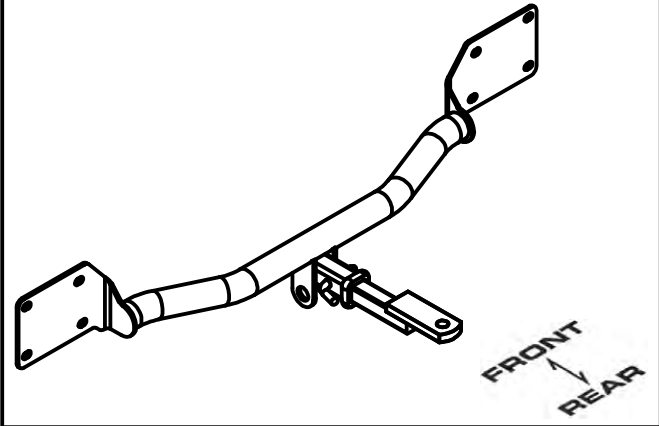

MAKE SURE YOUR HITCH MATCHES

**PERIODICALLY CHECK THIS RECEIVER HITCH TO ENSURE ALL FASTENERS ARE TIGHT AND ALL STRUCTURAL COMPONENTS ARE SOUND**

CURT Manufacturing Inc. warrants this product to be free of defects in material and/or workmanship at the time of retail purchase by the original purchaser. If the product is found to be defective, Curt Manufacturing Inc. may repair or replace the product at their option, when the product is returned, prepaid, with proof of purchase. Alteration to, misuse of, or improper installation of this product voids the warranty. Curt Manufacturing Inc.'s liability is limited to repair or replacement of products found to be defective, and specifically excludes liability for incidental or consequential loss or damage.

For more information log onto [www.curtmfg.com](http://www.curtmfg.com), & for helpful towing tips log onto [www.hitchinfo.com](http://www.hitchinfo.com)

## INSTALLATION WALKTHROUGH:

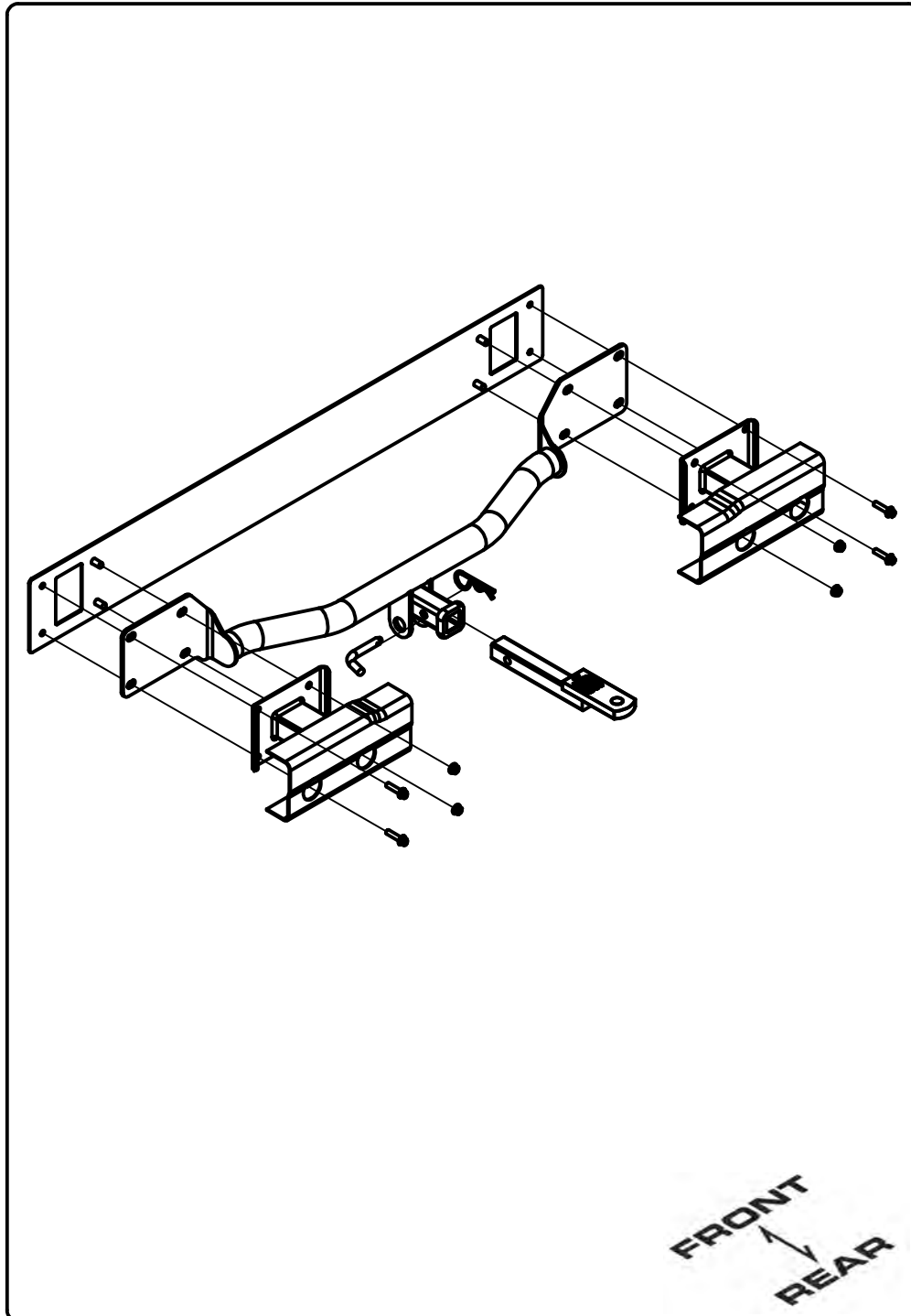

1. Remove (8) fasteners that secure the bumper cover.

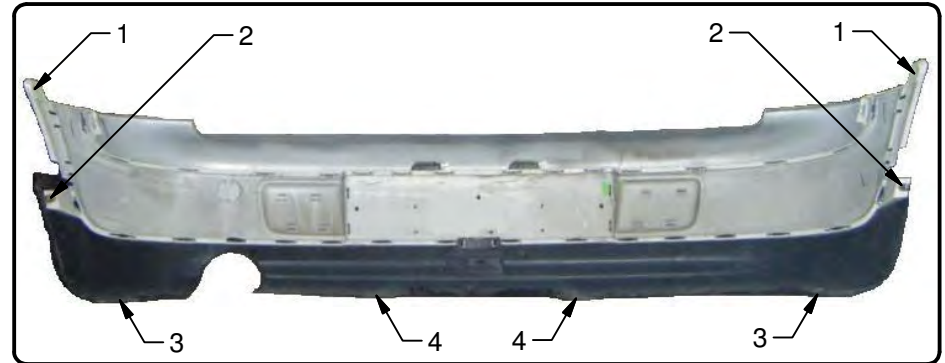

2. Using a phillips screwdriver remove fastener 2 from inside the rear wheel well. **Note:** If needed you may remove the rear wheels to access screws.

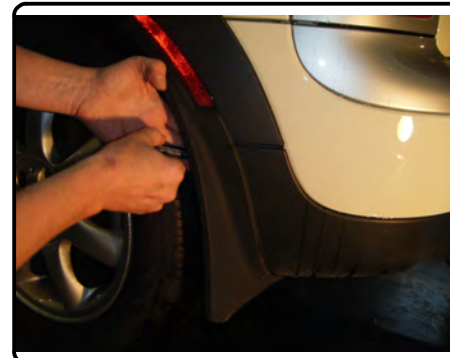

## INSTALLATION WALKTHROUGH:

3. Using phillips screwdriver, remove fastener 3 from the bottom of the bumper near the rear wheel well. The second photo shows the optional mud flap removed.

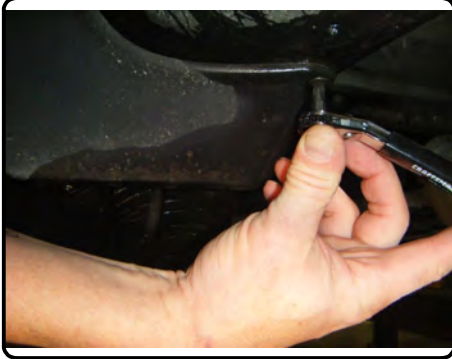

4. Slide one hand past the wheel well liner and fender flair, then push up on the (2) lower tabs that connect the fender flair to the bumper cover (Note: See the first photo in Step (5) for tab clarity). Using your other hand pry the rear fender flair away from the car until it pops free. Release side marker bulb from fender flair.

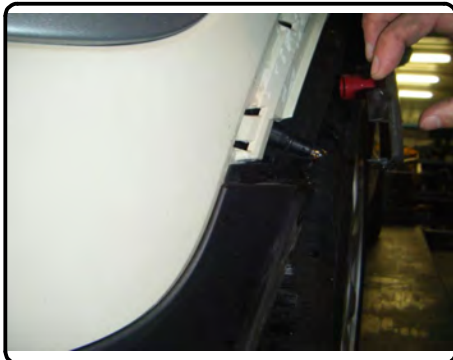
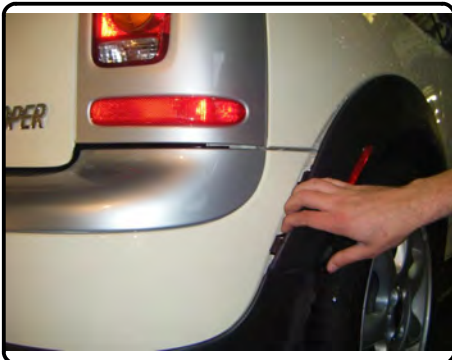

5. The first photo shows the lower fender flair tabs released. Using an offset phillips screw driver or wrench with a phillips driver bit remove hidden fastener 1 behind the fender flair.



6. Using a phillips screwdriver, remove fastener 4 from the bottom of bumper cover.

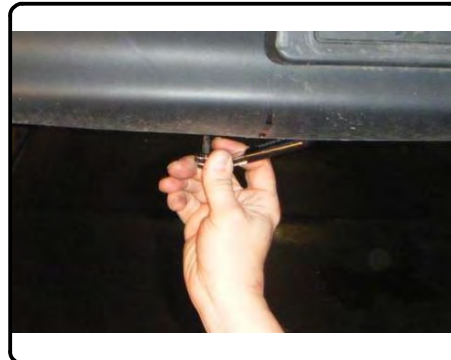

## INSTALLATION WALKTHROUGH:

7. Your bumper cover is now connecting only by locking tabs. Pull back on each side of the bumper cover until it pops free. Disconnect the (2) license plate light harnesses and the rear sensor harness. Place bumper cover in a safe area to prevent damage.



8. The first photo shows the bumper cover removed, exposing the aluminum bumper beam. Using a flat blade screwdriver remove the (7) wiring harness clips from the bumper beam.

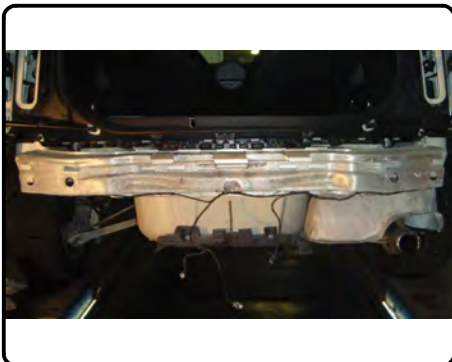

9. Using ratchet, socket extension, and 13mm socket remove (4) 8mm bolts and (4) 8mm nuts from bumper beam. Remove bumper beam from car. **NOTE:** Support bumper beam before removing bolts to prevent from falling

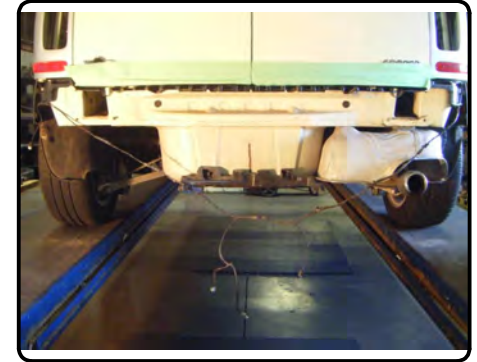
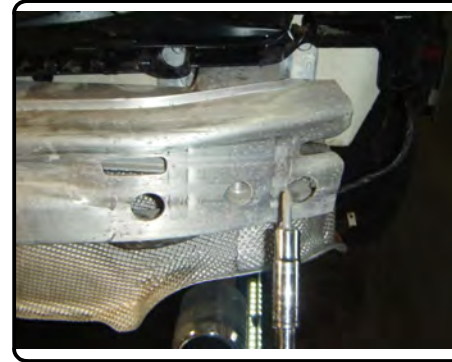

10. Raise hitch into position by aligning the holes and weld studs on the car with the holes in hitch. Sandwich the hitch between the bumper beam and the rear of the car.



## INSTALLATION WALKTHROUGH:

11. Secure hitch using (4) 8mm bolts and (4) 8mm nuts removed in Step (9). Torque all 8mm hardware to 18 ft-lbs.



12. An access hole will need to be drilled through your bumper cover to allow access to the receiver tube. Mark your drill location by measuring down from the bumper cover lip 3-3/4" and center by using the dimple in the license plate cover. Using a 2-1/2" hole saw drill through the license plate holder and bumper cover. When drilling make sure not to drill through the sensor bracket or loose wiring.  
**NOTE:** Verify drill location prior to drilling!

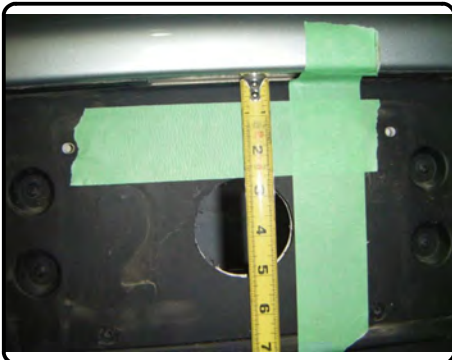

13. Your hitch is now fully installed and car is ready for re-assembly. Reinstall (7) wiring harness clips removed from bumper beam. Raise bumper cover to car and Reconnect the (2) license plate harnesses and rear sensor harness.

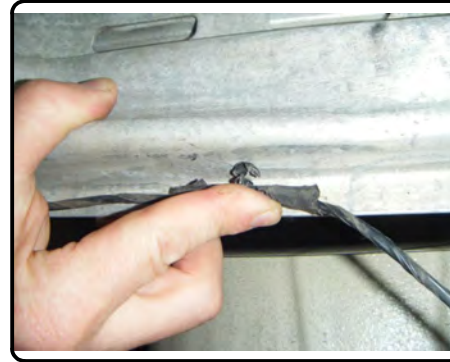

14. Align bumper cover and pull back on the fender flairs. Push bumper lock tabs in place until they snap. Re-attach side marker bulbs to fender flairs. Reinstall all (8) fasteners removed previously and snap fender flairs back into place.

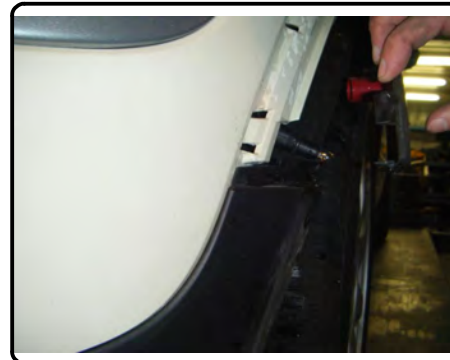

## INSTALLATION WALKTHROUGH:

15. The first photo shows hitch fully installed when not in use. The second photo shows hitch ready for use with safety chains attached. **Note:** Trailer not shown.

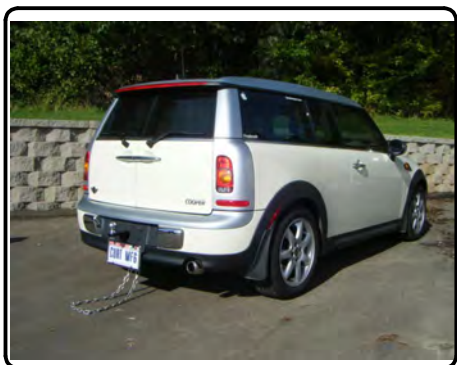

INSTALLATION IS NOW COMPLETE

## TOWING SAFETY INFORMATION

### Gross Trailer Weight / GTW

The Gross Trailer Weight is the weight of the trailer & cargo. Measure this by putting the fully loaded trailer on a vehicle scale.

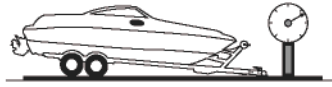

### Tongue Weight / TW

The downward force that is exerted on the hitch ball by the coupler. The tongue weight will vary depending on where the load is positioned in relationship to the trailer axle(s). To measure the tongue weight, use either a commercial scale or a bathroom scale with the coupler at towing height. When using a bathroom scale with heavier tongue weights, use the method shown and multiply the scale reading by 3.

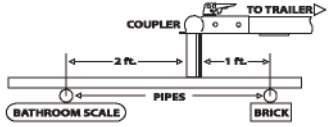

### Weight Carrying / WC

The total weight of both the trailer and the cargo inside. Never exceed the weight capacity of your trailer hitch.

### Weight Distribution / WD

Used to balance the weight of the cargo between the front and rear wheels throughout the trailer, allowing for better steering, braking, and level riding.



### Sway Control

A device used to reduce the lateral movements of the trailer that are caused by the wind. This works in conjunction with a weight distribution hitch. Do not use this on a class 1 or 2 hitch, or with surge brakes.

### How Much Can You Safely Tow?

TONGUE WEIGHT lbs	1000	2000	3000	4000	5000	6000	7000	8000	10,000	12,000
Tongue weight should be about 10 to 15 percent of the gross trailer weight.										
CLASS 1										
CLASS 2										
CLASS 3										
CLASS 4										
CLASS 5										
TRAILER TYPE										
Camper	11'	12'	13'	14'	15'	16'				
lbs	1100	1200	1300	1400	1500	1600				
Vacation	14'	16'	18'	20'	22'	24'	26'	28'	30'	32'
lbs	2100	2400	2700	3000	3300	3600	3900	4200	4500	4800
Vacation	14'	16'	18'	20'	22'	24'	26'	28'	30'	32'
lbs	2800	3200	3600	4000	4400	4800	5200	5600	6000	6400
5th Wheel										

Refer to owner's manual for towing capabilities and limitations.

### Ball Mount

The ball mount is placed inside the opening of the receiver hitch which is mounted to the vehicle. Make sure a hitch pin and clip is properly securing the ball mount to the receiver hitch before you begin towing.

- A: Rise. B: Drop. C: Hole Size. D: Length.

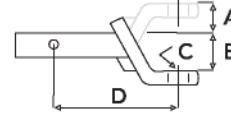

### Trailer Ball

The connection from the hitch to the trailer. There are many factors that determine the correct hitch ball:

- Number one is the hitch ball's gross trailer weight rating.
- The mounting platform must be at least 3/8" thick.
- The hole diameter must not be more than 1/16" larger than the threaded shank.
- Every time you tow, check the nut and lock washer to make sure they are fastened securely.
- A: Ball Dia. B: Shank Dia. C: Shank Length. D: Shank Rise.

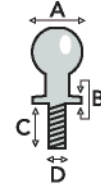

### Coupler

The component that is placed over the trailer ball to connect the vehicle to the trailer. Be sure that the coupler size matches the size of the hitch ball and that the coupler handle is securely fastened. To determine what size hitch ball you need for your application you will need to know the size of coupler that is on the trailer. Be sure your coupler is properly adjusted to the ball you are using.

NOTE: For added security the use of safety devices such as Coupler Safety Pins and Locks is strongly recommended.

### Safety Chains

Safety chains are a requirement and should be crossed under the tongue of the trailer so that the tongue will not drop to the road if it becomes separated from the hitch. Always leave enough slack so you can turn. Never allow the safety chains to drag on the ground and never attach the chains to the bumper.

Trailer Classification: Safety Chain Breaking Force - Minimum

Class 1: 2,000 lbs. (8.9 kN)

Class 2: 3,500 lbs. (15.6 kN)

Class 3: 5,000 lbs. (22.2 kN)

The strength rating of each length of safety chain or its equivalent and its attachments shall be equal to or exceed in minimum breaking force the GVWR (Gross Vehicle Weight Rating) of the trailer.

### Electrical

Trailer lights, Electric Brakes, Break-away systems - Every time you tow, be sure to check that all components are working properly.

Wiring identification by color:

