

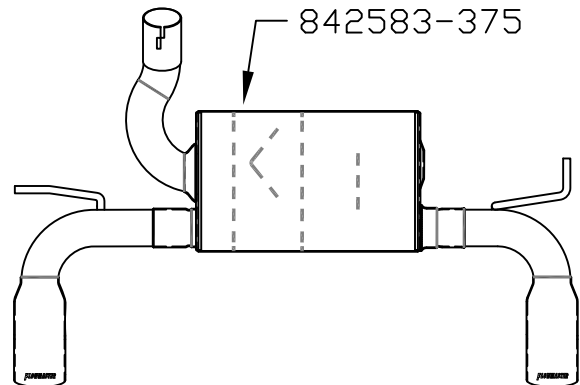

# FORCE II™

## 409S Stainless Steel

Installation diagram for:  
**SYSTEM #817729**  
2012-2015 JEEP WRANGLER JK  
2 & 4 DOOR · 3.6L V6 ENGINE



### PACKING LIST

<u>Qty</u>	<u>Description</u>	<u>Part #</u>
1	Muffler	842583-375
1	Parts Kit	PK791
1	Clamps	MC250BS
1	Hanger Keeper	HW503

09/08/14

### Removal:

- 1) Raise the vehicle up on a hoist or rack to working height. If you do not have access to a hoist or rack raise the vehicle and support securely with jack stands.
- 2) Loosen the band clamp on the inlet side of the muffler (left side).
- 3) Support the muffler with a stand, and separate the two hanger rods from the rubber mounts. Remove the muffler assembly.

### Installation:

- 1) Before installing anything, prep the clamp supplied in the hardware kit by removing the nut, and applying a thick lubricant such as white grease or anti-seize to the threads.
- 2) Place a clamp on the muffler inlet and tighten enough to hold in place, but still allow for adjustment.
- 3) Slip the muffler inlet onto the factory pipe and support with a stand, connect the two hangers on the assembly to the rubber mounts on the vehicle.
- 4) Install the push-on hanger keeper onto the left side hanger rod to prevent it from slipping out of the rubber mount.
- 5) Adjust the position of the muffler provide a satisfactory fit. Tighten down the clamped connection securely.