



# AIRCHARGER®

## HIGH-FLOW INTAKE KITS

NOT LEGAL FOR SALE OR USE ON ANY POLLUTION CONTROLLED MOTOR VEHICLE IN CALIFORNIA OR STATES ADOPTING CALIFORNIA EMISSION PROCEDURES.  
See knfilters.com for CARB status on each part for a specific vehicle

### INSTALLATION INSTRUCTIONS

**63-6015**  
**NISSAN**  
**2004-08 Maxima**  
**2004-06 Altima**  
**V6-3.5L**

**TOOLS NEEDED:**

- Ratchet
- Extension
- 10mm Socket
- 3/4" Wrench
- 17mm Wrench
- 10mm Wrench
- Flat Blade Screwdriver
- T20 Torx Wrench
- 5mm Allen Wrench
- 4mm Allen Wrench
- 3mm Allen Wrench
- Pliers

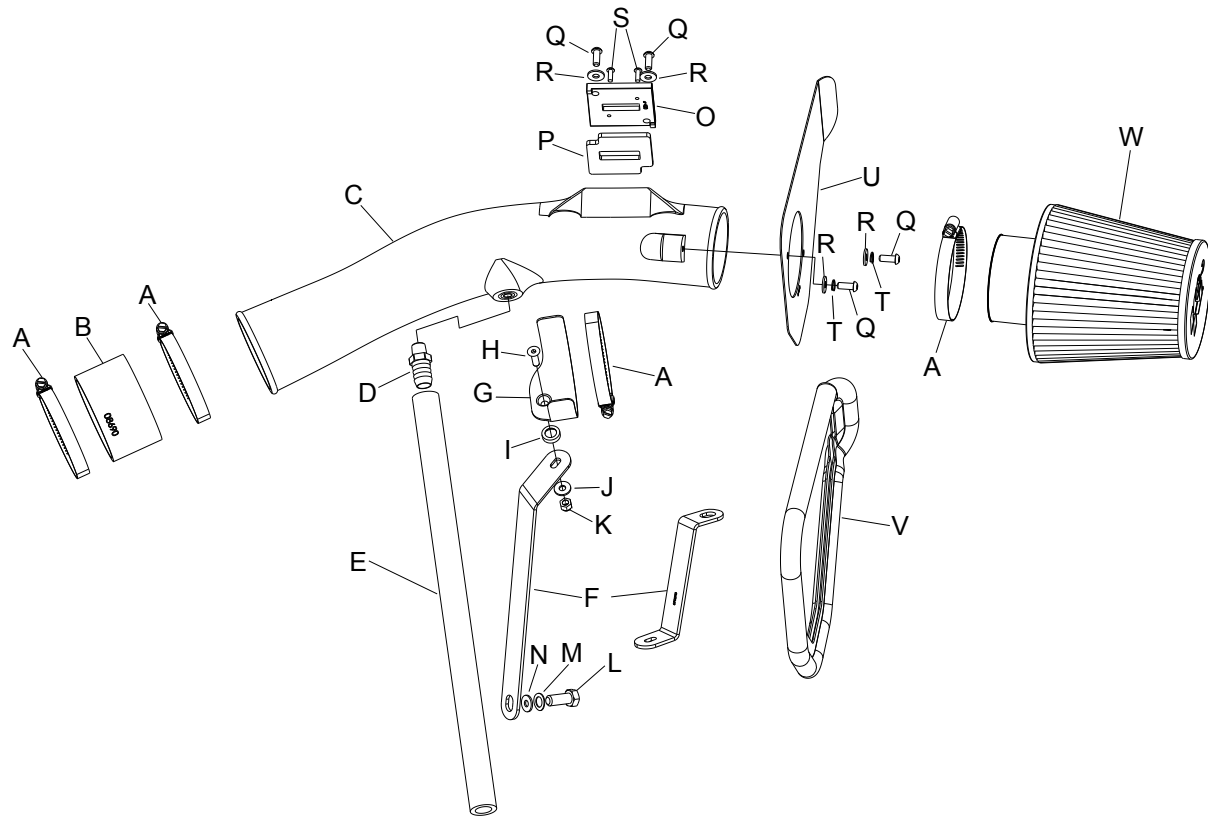

**PARTS LIST:**

Description	Qty.	Part #	Description	Qty.	Part #	Description	Qty.	Part #
A Hose Clamp #48	4	08601	I Washer; Conical, Nylon, Black	1	08180	Q Bolt; M6 X 1.00 X 16MM , Button	4	07730
B Hose; 3.25"ID X 2"L, Black	1	08690	J Washer; 1/4"ID X 5/8"OD - SAE	1	08275	R Washer; 6MM Flat, SS	4	08269
C Intake Tube	1	087213	K Nut; 6MM Nylock, Hex Head, SS	1	07512	S Screw; M4- .7 X 12, Button Head	2	07726
D Vent; STRT, 5/8 Barbed 1/4 NPT	1	08911	L Bolt; M10-1.5 X 25MM Hex HD.	1	07702	T Washer; 1/4" Lock, ZN	2	08198
E Hose; 5/8"ID X 17"L, Silicone	1	08681	M Washer; 10MM Wave	1	08175	U Heat Shield	1	07652
F Bracket; Mild STL, FB/PC	1	06489 / 070090	N Washer; 3/8" Flat Washer, SS	1	08134	V Edge Trim	1	102489
G Bracket; Saddle, S/S	1	078855	O Adaptor; Nylon 6/6 GF, Black	1	21515	W Air Filter	1	RC-4180
H Bolt; 6MM-1.00 X 20MM F/H/A	1	08376	P Gasket; 3/16 Poron	1	09069			

**NOTE: FAILURE TO FOLLOW INSTALLATION INSTRUCTIONS AND NOT USING THE PROVIDED HARDWARE MAY DAMAGE THE INTAKE TUBE, THROTTLE BODY AND ENGINE.**

**TO START:**

1. Turn off the ignition and disconnect the negative battery cable.  
**NOTE: Disconnecting the negative battery cable erases pre-programmed electronic memories. Write down all memory settings before disconnecting the negative battery cable. Some radios will require an anti-theft code to be entered after the battery is reconnected. The anti-theft code is typically supplied with your owner's manual. In the event your vehicles' anti-theft code cannot be recovered, contact an authorized dealership to obtain your vehicles anti-theft code.**

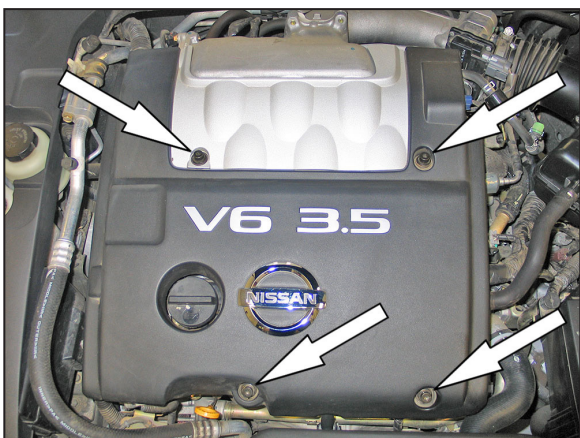

2. Remove the four bolts that retain the engine cover, then remove the engine cover from the engine.

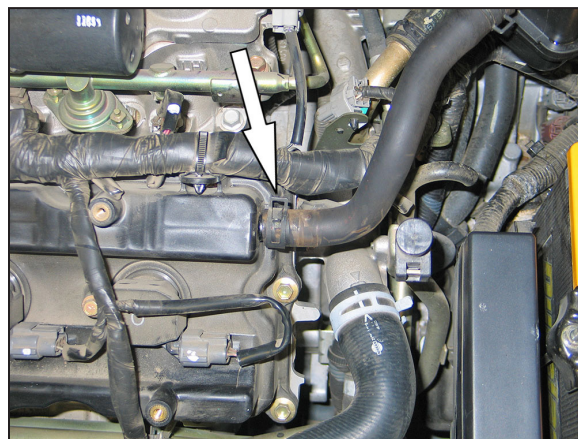

3. Release the spring clamp and disconnect the crankcase vent hose.

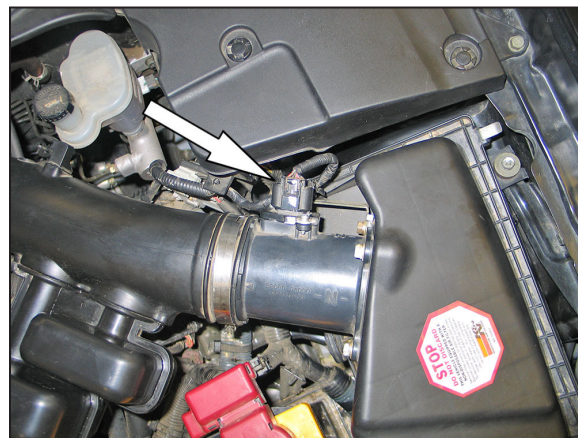

4. Disconnect the mass air sensor electrical connection.



5. Loosen the two hose clamps that secure the stock intake tube to the throttle body and stock mass air sensor.



6. Remove the stock intake tube from the vehicle.

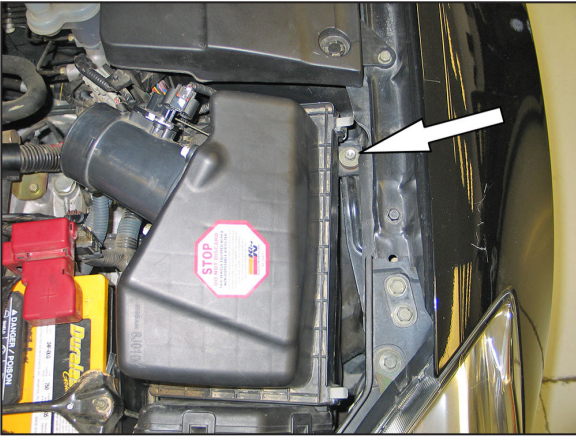

7. Remove the bolt that secures the airbox to the inner fender.



8. Lift the airbox up from the mounting grommets. Detach the airbox from the fresh air duct, then remove the airbox from the vehicle.  
**NOTE: K&N Engineering, Inc., recommends that customers do not discard factory air intake.**



9. Install silicone hose (#08690) onto the throttle body and secure with the provided hose clamp.

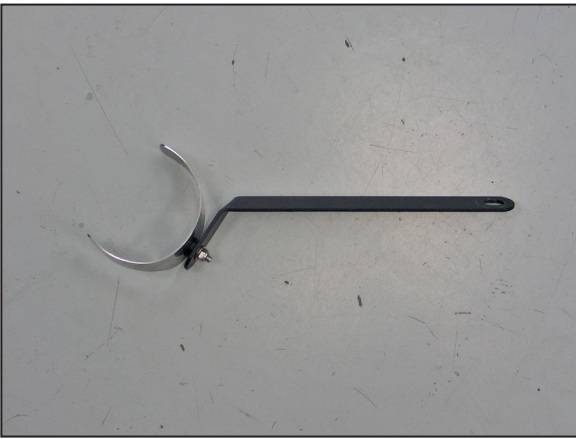

10. On 2004-2006 model vehicles, secure the saddle clamp to the tube mounting bracket (06489) with the provided hardware as shown.

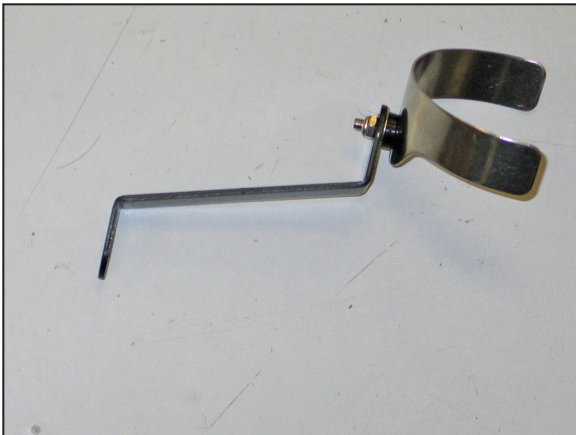

10a. On 2007 and later model vehicles, Secure the saddle clamp to the tube mounting bracket (070090) with the provided hardware as shown.

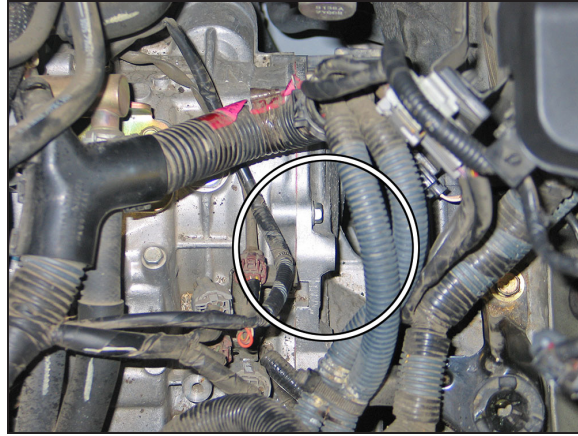
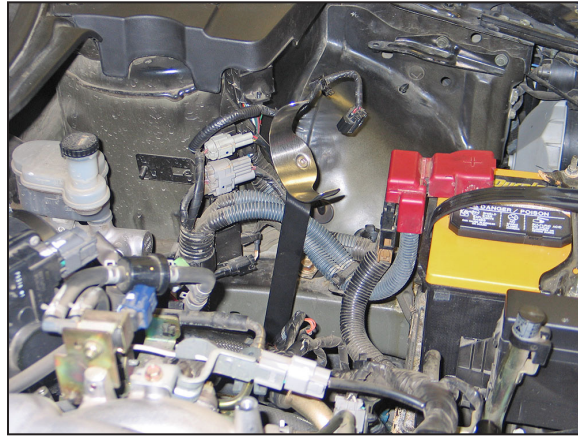

11. On 2004-2006 model vehicles, secure the tube mounting bracket assembly (06489) to the threaded boss on the transmission with the provided hardware.

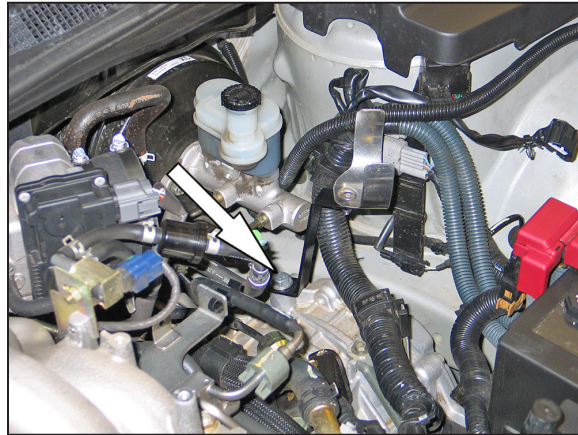

11a. On 2007 and later model vehicles, secure the tube mounting bracket assembly (070090).



12. Install the 1/4" NPT fitting into the K&N® intake tube as shown.  
**NOTE: Plastic NPT fittings are easy to cross thread. Install the vent fitting "hand" tight, then turn it two complete turns with a wrench.**

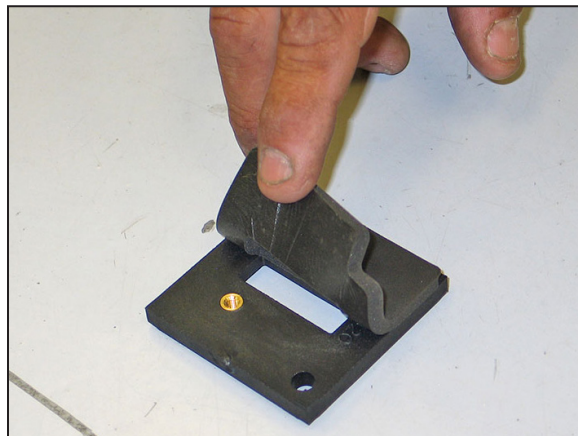

13. Install the provided gasket onto the K&N® mass air sensor adapter.

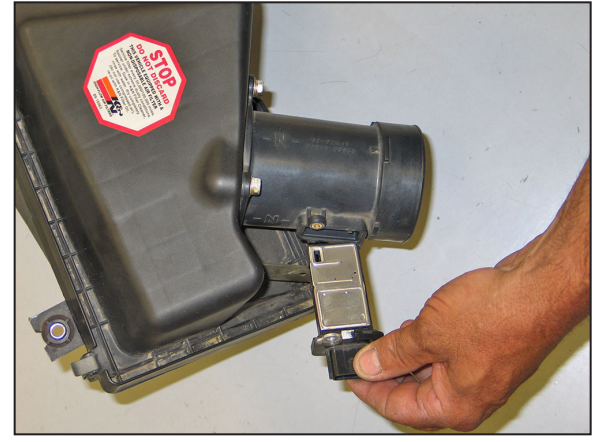

14. Remove the mass air sensor mounting screws. Then, remove the mass air sensor from the stock mass air sensor housing.

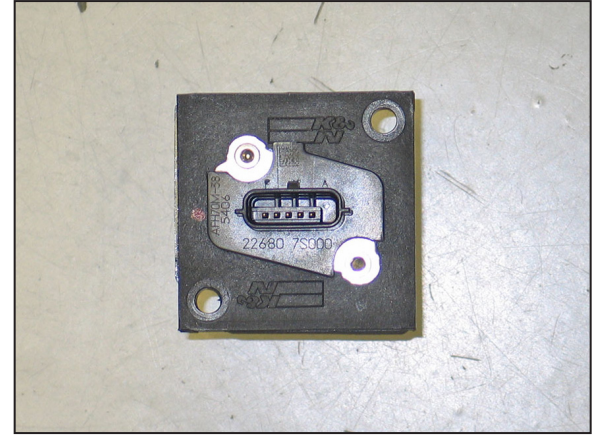

15. Install the mass air sensor into the K&N® mass air sensor adapter. Secure with the provided hardware.

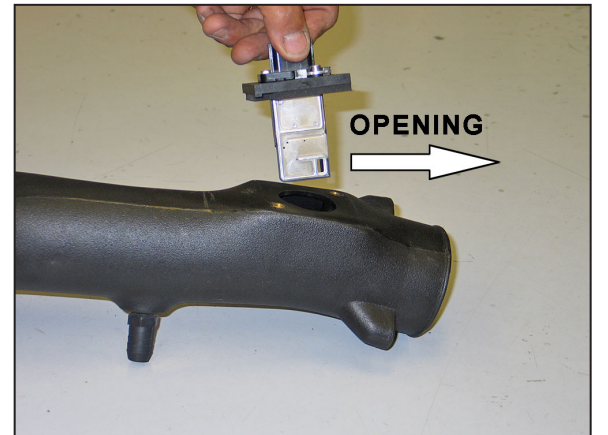

16. Install the mass air sensor assembly into the K&N® intake tube and secure with the provided hardware.  
**NOTE: The opening in the mass air sensor must be installed facing towards the inlet end of the tube as shown.**



17. Install the provided edge trim onto the heat shield as shown.  
**NOTE: Some trimming of the edge trim may be necessary.**



18. Secure the heat shield assembly to the K&N® intake tube with the provided hardware.



19. Install the K&N® intake tube assembly into the silicone hose at the throttle body and align with the saddle bracket installed in step #11. Secure the K&N® intake tube assembly with the provided hose clamps.



20. Install the provided crankcase vent hose onto the vent port on the valve cover. Connect the open end to the 1/4" NPT fitting installed into the K&N® intake tube.



21. Re-install the engine cover and secure with the stock bolts.



22. Install the K&N® air filter and secure with the provided hose clamp.

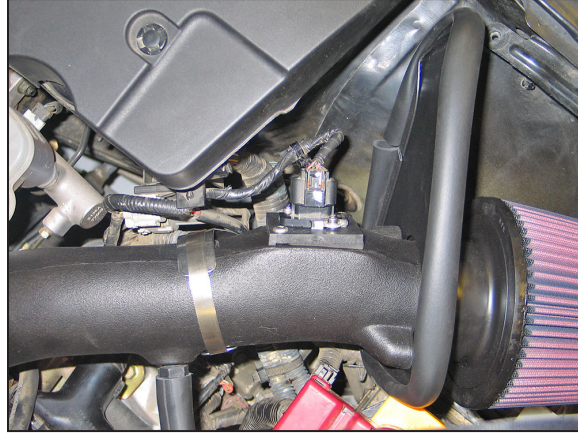

23. Re-connect the mass air sensor electrical connection.



24. Reconnect the vehicle's negative battery cable. Double check to make sure everything is tight and properly positioned before starting the vehicle.

25. It will be necessary for all K&N® high flow intake systems to be checked periodically for realignment, clearance and tightening of all connections. Failure to follow the above instructions or proper maintenance may void warranty.

#### ROAD TESTING:

1. Start the engine with the transmission in neutral or park, and the parking brake engaged. Listen for air leaks or odd noises. For air leaks secure hoses and connections. For odd noises, find cause and repair before proceeding. This kit will function identically to the factory system except for being louder and much more responsive.

2. Test drive the vehicle. Listen for odd noises or rattles and fix as necessary.

3. If road test is fine, you can now enjoy the added power and performance from your kit.

4. K&N Engineering, Inc., requires cleaning the intake system's air filter element every 100,000 miles. When used in dusty or off-road environments, our filters will require cleaning more often. We recommend that you visually inspect your filter once every 25,000 miles to determine if the screen is still visible. When the screen is no longer visible some place on the filter element, it is time to clean it. To clean and re-oil, purchase our filter Recharger® service kit, part number 99-5050 or 99-5000 and follow the easy instructions.

**NOT LEGAL FOR SALE OR USE ON ANY POLLUTION CONTROLLED MOTOR VEHICLE IN CALIFORNIA OR STATES ADOPTING CALIFORNIA EMISSION PROCEDURES.**

See [knfilters.com](http://knfilters.com) for CARB status on each part for a specific vehicle