



INSTALLATION INSTRUCTIONS FOR PART 99-8213

APPLICATIONS Toyota Prius 2004-2009

99-8213



KIT FEATURES

- ISO DIN Head Unit Provision with Pocket

KIT COMPONENTS

- A) Radio Housing with Pocket • B) ISO Pocket • C) (2) Phillips Screws • D) Resistor

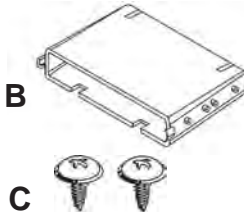
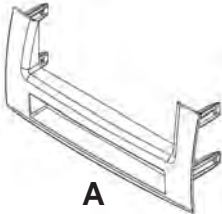

WIRING AND ANTENNA CONNECTIONS (Sold Separately)

Harness:

- 70-1761 - Toyota harness 1987-up
- TYT0-01 - Toyota amp interface harness 2003-up

Antenna Adapter:

- Not required

TOOLS REQUIRED:

Small Flat Blade Screwdriver/ Panel Removal Tool

- Phillips Screwdriver • Socket Set • Tape or Heat Shrink



1-800-221-0932



www.metraonline.com

© COPYRIGHT 2004-2009 METRA ELECTRONICS CORPORATION



TABLE OF CONTENTS

Dash Disassembly

- Toyota Prius 2004-2009 1,2

Kit Assembly

- ISO DIN Head Unit Provision with Pocket 3

- Climate Control Wiring 4

Final Assembly 5

***Note:**

Refer also to the instructions included with the aftermarket radio.



KNOWLEDGE IS POWER

Enhance your installation and fabrication skills by enrolling in the most recognized and respected mobile electronics school in our industry. Log onto www.installerinstitute.com or call 800-354-6782 for more information and take steps toward a better tomorrow.

Toyota Prius 2004-2009

1 Disconnect the negative battery terminal to prevent an accidental short circuit.

2 Unsnap panel with vent on driver's side and remove. (Figure A)

3 Remove (2) Phillips screws on panel below steering column with hood release on it and remove panel. (Figure A)

4 Unclip and remove panel surrounding under side of steering column. (Figure B)

5 Unclip and remove panel above steering column. (Figure C)

6 Unclip and remove vent panel surrounding the shifter. (Figure D)

7 Open glove box and remove vent panel next to the radio. (Figure D)

A

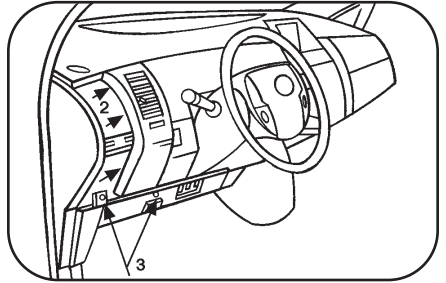

B

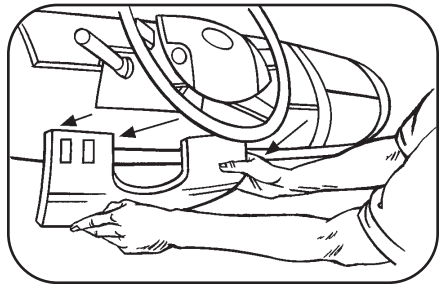

C

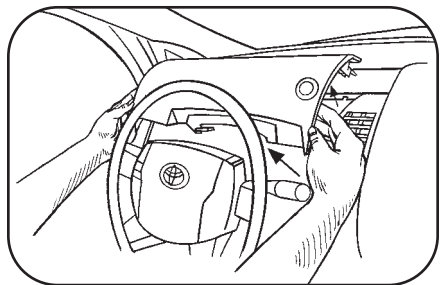

D

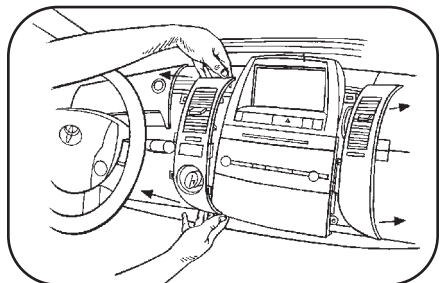

Toyota Prius 2004-2009

- 8** Remove (2) Phillips screws from flip open panel below radio, unclip and remove. (Figure E)
- 9** Remove (2) 10mm bolts from info center display above radio, unclip and remove. (Figure F)
- 10** Remove (2) 10mm bolts from top of radio assembly. (Figure G)
- 11** Remove (2) 10mm bolts from bottom of radio assembly, unclip radio and remove. (Figure G)
- 12** Remove (4) Phillips screws to remove factory radio from bracket assembly. Note position of factory radio in bracket assembly for reference in step 1 of Kit Assembly. (Figure H)

Continue to final assembly.

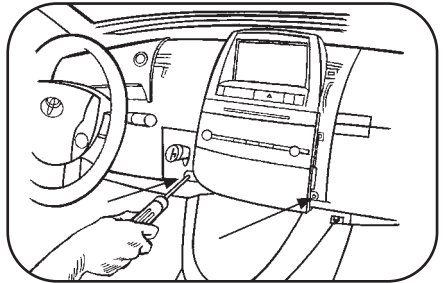
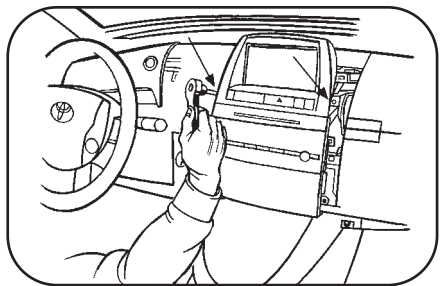
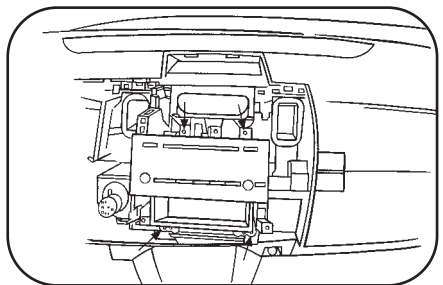
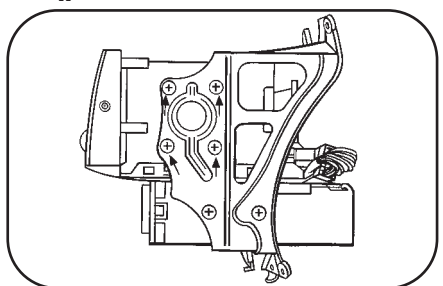
E

F

G

H

ISO DIN HEAD UNIT PROVISION WITH POCKET

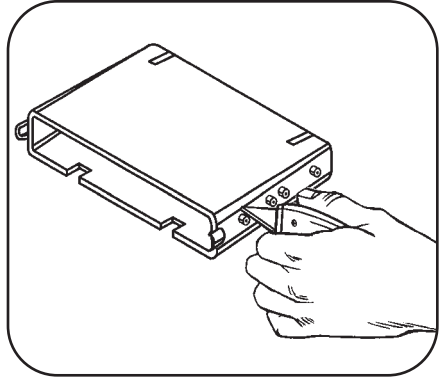
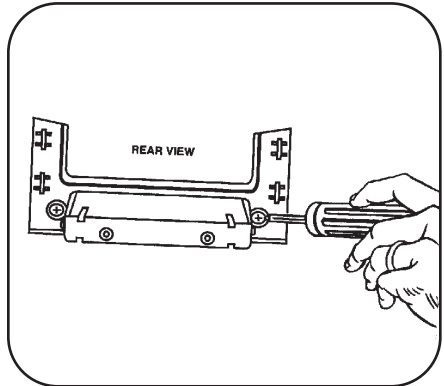
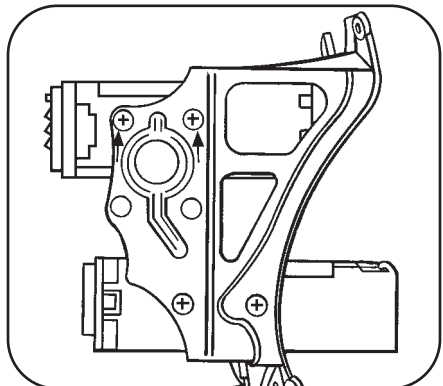
**Note: Refer also to the instructions included with the aftermarket radio.*

- 1** For the pocket to fit properly inside the dash the sides of the pocket need to be trimmed. (Figure A)
- 2** Using a utility knife carefully cut off the 4 round pieces on each side of the pocket. (Figure A)
- 3** Attach the pocket to the back of the trim plate using the Phillips Screws supplied with the kit. (Figure B)
- 4** Position aftermarket head unit into factory audio bracket assembly and secure using the top (2) screw positions and the hardware supplied with the new head unit. (Figure C)

Continue to climate control wiring.

A

B

C

CLIMATE CONTROL WIRING

**Note: Refer also to the instructions included with the aftermarket radio.*

For the climate controls to operate properly, the following steps need to be followed:

- 1 Locate the 20 way white connector that has 5 wires in it that was plugged into the factory radio.
- 2 You will need the small gauge white wire in pin 10 and the small gauge pink wire in pin 9. The 3 remaining larger gauge wires are not needed at this time. (see diagram)
- 3 Strip back the white and pink wires, connect one side of the 68 OHM resistor to the white wire and connect the other side of the resistor to the pink wire (see diagram).
- 4 When completed be sure to tape up the wires including the resistor to protect them from coming into contact with any metal, and push the 20 way connector back into the dash. (see diagram)

Continue to final assembly.

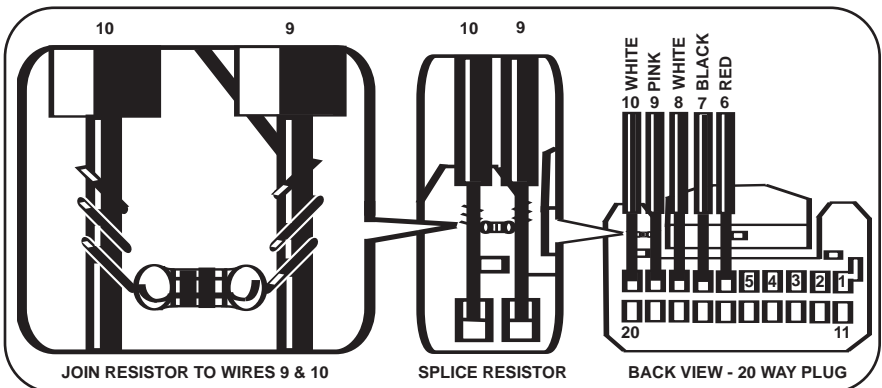

FINAL ASSEMBLY

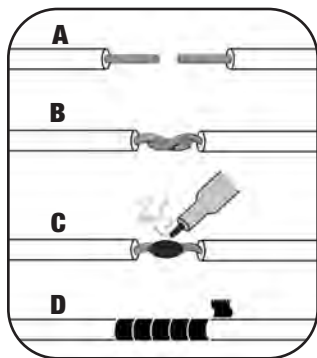

(A) Strip wire ends back 1/2"

B) Twist ends together

C) Solder

D) Tape

- 1 Locate the factory wiring harness in the dash. Metra recommends using the proper mating adapter and making connections as shown. (Isolate and individually tape off the ends of any unused wires to prevent electrical short circuit.)
- 2 Re-connect the negative battery terminal and test the unit for proper operation.
- 3 Reassemble radio and dash assemblies in reverse order of disassembly using the 99-8213 in place of the factory panel.

FINAL WIRING CONNECTIONS

Make wiring connections using the EIA color code chart shown below and the instructions included with the head unit. Metra recommends making connections as shown below; Strip, Splice, Solder, Tape. Isolate and individually tape off ends of any unused wires to prevent electrical short circuit.

METRA / EIA WIRING CODE

12V Ignition / Acc.	Red	Right Front (+)	Gray
12V Batt / Memory.	Yellow	Right Front (-).	Gray/ Black
Ground.	Black*	Left Front (+)	White
Power Antenna.	Blue	Left Front (-).	White / Black
Amp Turn-On	Blue / White	Right Rear (+)	Violet
Amp Ground.	Black / White	Right Rear (-).	Violet / Black
Illumination	Orange	Left Rear (+)	Green
Dimmer	Orange / White	Left Rear (-)	Green / Black

*NOTE: When a Black wire is not present, ground radio to vehicle chassis.

All colors may not be present on all leads due to manufacturer's specifications.

99-8213 INSTRUCTIONS



1-800-221-0932



www.metraonline.com

REV. 07/01/09 © COPYRIGHT 2004-2007 METRA ELECTRONICS CORPORATION INST99-8213