



## INSTALLATION INSTRUCTIONS FOR PART 99-8710

### APPLICATIONS

**Mercedes C-Class 2001-2004**  
**Mercedes CLK 2004**

# 99-8710

#### KIT FEATURES

- DIN Radio Provision with Pocket



#### KIT COMPONENTS

- A) Radio Housing

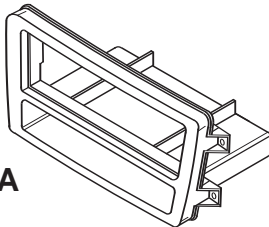

#### TOOLS REQUIRED:

- Small Flat Blade Screwdriver/ Panel Removal Tool  
• Phillips Screwdriver • Torx Screwdriver



1-800-221-0932



[www.metraonline.com](http://www.metraonline.com)

© COPYRIGHT 2004-2008 METRA ELECTRONICS CORPORATION

## **TABLE OF CONTENTS**

### **Dash Disassembly**

- Mercedes C-Class 2001-2004 ..... 1**
- Mercedes CLK 2004 ..... 2**

### **Kit Assembly**

- DIN Mount Radio Provision ..... 3**

- Final Assembly ..... 4**

**\*Note:**

**Refer also to the instructions included with the aftermarket radio.**



### **KNOWLEDGE IS POWER**

Enhance your installation and fabrication skills by enrolling in the most recognized and respected mobile electronics school in our industry. Log onto [www.installerinstitute.com](http://www.installerinstitute.com) or call 800-354-6782 for more information and take steps toward a better tomorrow.

**MERCEDES C-CLASS 2001-2004**

- 1** Disconnect the negative battery terminal to prevent an accidental short circuit.
- 2** Unclip shifter trim (with gear indicators).
- 3** Unclip and remove center console trim panel. (Figure A)
- 4** Remove the ashtray insert by releasing (2) plastic clips on the bottom lip of the ashtray assembly. (Figure B)
- 5** Using a small flat screwdriver push the lower clip ("A") inward and rotate the vent upward to expose (1) Torx head screw. Loosen the Torx screw. (It is not necessary to remove the screw.) (Figure C)
- 6** Using a small flat screwdriver push the upper clip ("B") inward and rotate the vent downward to expose (1) spring clip in the top corner ("C"). Push down on the spring clip. (Figure C)
- 7** Repeat steps 5 and 6 for the other vent and remove vent assembly.
- 8** Unclip the (2) metal clips at the bottom edge of the climate control/radio trim panel and remove trim panel.
- 9** Remove (4) Phillips screws securing factory radio then unplug and remove the radio.

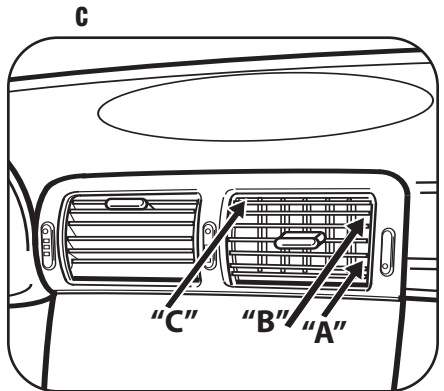
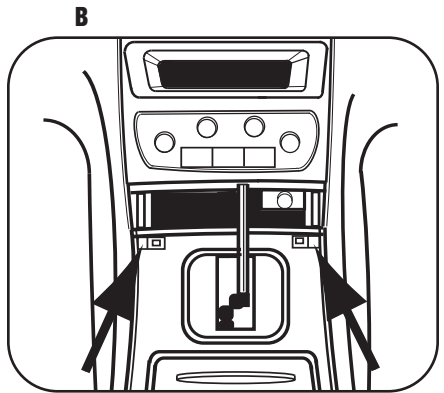
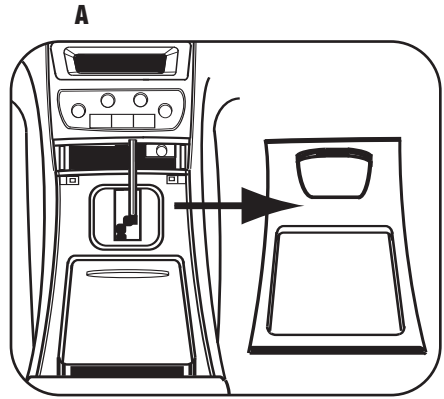

*Continue to kit assembly.*

## MERCEDES CLK 2004

*\*Note: Refer also to the instructions included with the aftermarket radio.*

- 1 Disconnect the negative battery terminal to prevent an accidental short circuit.
- 2 Loosen shifter boot and pull up over shifter handle. (Figure A)
- 3 Turn the retainer on the shifter 1/2 turn to remove shifter handle and boot. (Figure B)
- 4 Unclip and remove the shifter trim panel. (Figure C)
- 5 Remove the ashtray insert by releasing (2) plastic clips on the bottom lip of the ashtray assembly. (Figure D)
- 6 Remove (2) screws from bottom of climate control/radio trim panel.
- 7 Unclip climate control/radio trim panel. Unplug and remove trim panel.
- 8 Remove the (4) screws securing the radio then unplug and remove the radio.

*Continue to final assembly.*

**A**

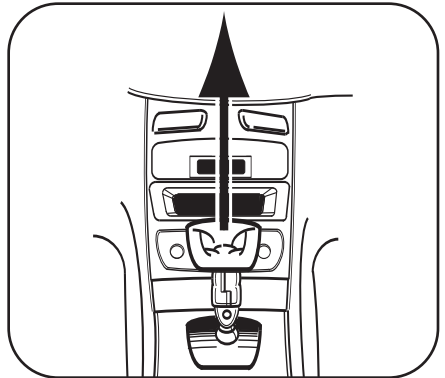

**B**

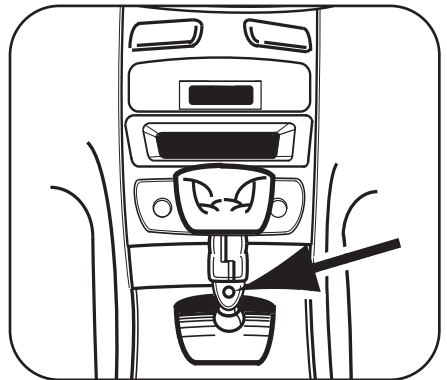

**D**

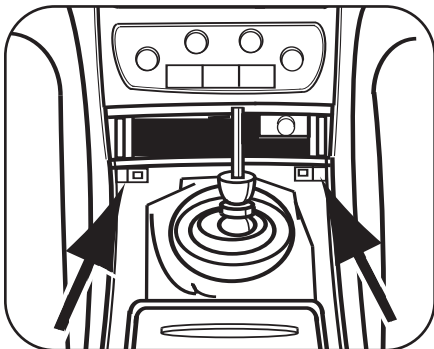

**C**

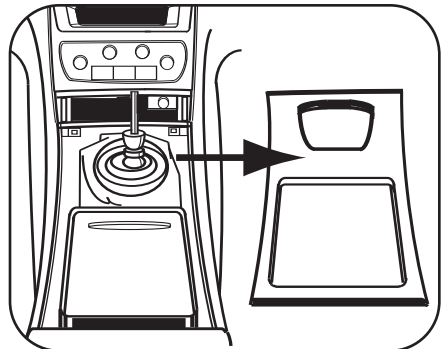

## DIN MOUNT RADIO PROVISION

*\*Note: Refer also to the instructions included with the aftermarket radio.*

**1** Slide the appropriate bracket into the trim plate aligning the holes in the trim plate to the clips on the bracket. (Figure A)

**2** Slide the DDIN radio unit into the trim plate bracket assembly and secure the unit to the kit using the screws supplied with the head unit. (Figure B)

*Continue to final assembly.*

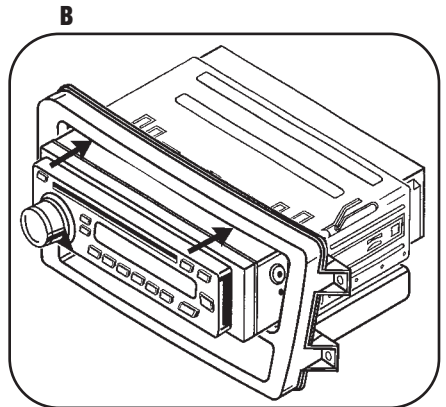
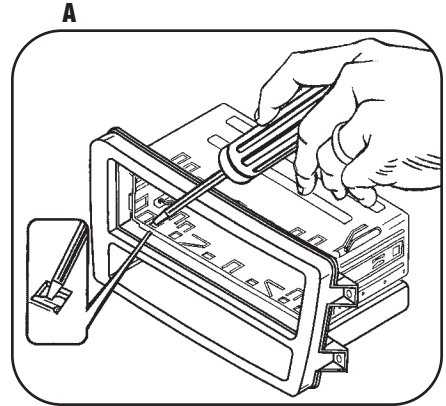

## FINAL ASSEMBLY

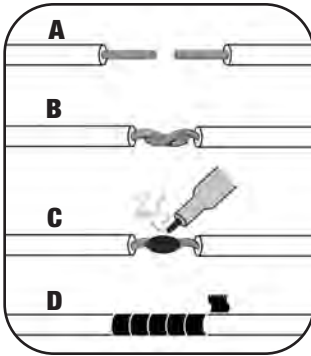

**(A) Strip wire ends back 1/2"**

**B) Twist ends together**

**C) Solder**

**D) Tape**

- 1 Locate the factory wiring harness in the dash. Metra recommends using the proper mating adapter and making connections as shown. (Isolate and individually tape off the ends of any unused wires to prevent electrical short circuit.)
- 2 Re-connect the negative battery terminal and test the unit for proper operation.
- 3 Reassemble radio and dash assemblies in reverse order of disassembly.

### FINAL WIRING CONNECTIONS

Make wiring connections using the EIA color code chart shown below and the instructions included with the head unit. Metra recommends making connections as shown below; Strip, Splice, Solder, Tape. Isolate and individually tape off ends of any unused wires to prevent electrical short circuit.

#### METRA / EIA WIRING CODE

12V Ignition / Acc. . . . .	Red	Right Front (+) . . . . .	Gray
12V Batt / Memory. . . . .	Yellow	Right Front (-). . . . .	Gray/ Black
Ground. . . . .	Black*	Left Front (+) . . . . .	White
Power Antenna. . . . .	Blue	Left Front (-). . . . .	White / Black
Amp Turn-On . . . . .	Blue / White	Right Rear (+) . . . . .	Violet
Amp Ground. . . . .	Black / White	Right Rear (-). . . . .	Violet / Black
Illumination . . . . .	Orange	Left Rear (+) . . . . .	Green
Dimmer . . . . .	Orange / White	Left Rear (-). . . . .	Green / Black

**\*NOTE:** When a Black wire is not present, ground radio to vehicle chassis.

All colors may not be present on all leads due to manufacturer's specifications.



**99-8710**

## **NOTES**

---

---

---

---

---

---

---

---

---

---

---

---

---

---

---

---

---

---

---

---

---

---

---

---

---

---

---

---

---

---

# 99-8710 INSTRUCTIONS



1-800-221-0932



[www.metraonline.com](http://www.metraonline.com)

REV. 08/07/08 © COPYRIGHT 2004-2008 METRA ELECTRONICS CORPORATION INST99-8710