

MSD **IGNITION** **INSTALLATION INSTRUCTIONS**

MSD Pro-Billet LT-1 Distributor **'94-'96 B and D-Bodies, '95-'97 F-Body,** **'95-'96 Corvette, PN 83811**

Parts Included:

1 - Distributor	1 - Isolator	3 - 1/4-20 x 2" Socket Head Cap Screws
1 - Cap	2 - Rotor Screws	5 - 8-32 x 0.5" Phillips Screws
1 - Rotor	1 - O-ring	1 - Removal Tool

IMPORTANT: Due to the number of applications and years that the LT-1 Distributor is used on, it is highly recommended to have the Service Manual for your vehicle during this installation.

IMPORTANT NOTES BEFORE INSTALLATION

Throughout its course, the GM LT-1 engine used two different drive mechanisms to connect the cam to the distributor. Figure 1 shows the drive for the MSD PN 83811 Distributor. This design is used in the later model distributors.



Figure 1 The Drive Mechanism of the PN 83811 Distributor.

Before removing the distributor it is recommended to mark the location of the rotor. This is to ensure that the distributor and cam are indexed correctly prior to reassembly.

Be sure that the O-ring between the distributor cap and the housing is in place before installing the cap. The O-ring must be stretched out, then installed onto the housing. It will shrink back to size.

TIMING INFORMATION

Since the timing of the MSD Pro-Billet Distributor can be adjusted, it is recommended that a timing indicator and mark be fabricated prior to installing the distributor. This way, the timing can be recorded so the MSD Distributor can be set to the same amount. From the factory, the MSD Distributor is set to the OEM specs (one and a half turns).

The MSD Distributor can alter the timing $\pm 6^\circ$, with a quarter turn equalling 1° of timing. The adjusting screw has a soft Loctite compound applied to it for a seal (Figure 2). Repeated adjustments may loosen the screw. If this occurs, remove the screw and apply Blue Loctite to the threads. The screw can safely be removed from the distributor.

Too much advance may cause detonation resulting in the ECU retarding the timing through the engine's knock sensor.

When adjusting the timing, take note that the ECU varies the timing at an idle. It is recommended to bring the engine rpm up to 1,500 - 2,000 when setting the timing.



Figure 2 Adjusting the Timing.

DISASSEMBLY

1. Disconnect the negative battery cable.
2. Locate the radiator petcock and drain the coolant from the system.
3. Disconnect the TPS and IAC sensors (Figure 3).
4. Disconnect the MAF and ICT sensors (Figure 4). Then, remove the air inlet boot.
5. Once the coolant is drained, remove the upper radiator hose from the thermostat housing.
6. Loosen the three bolts that secure the crankshaft pulley/hub assembly. Do not remove them entirely at this time.
7. Remove the accessory drive belt by moving the spring loaded idler pulley. Use caution as this pulley is spring loaded! The belt will slide off the pulley system and the idler pulley will settle beyond its installed position.
8. Once the belt is removed, proceed with removing the pulley from the crankshaft hub by pulling the three retaining bolts. A puller will be required (Figure 5).
9. It may be necessary to remove the cooling fan. This is done by removing the four bolts and disconnecting the wiring connection.
10. Disconnect the air pump power wires and remove the air pump from its mounting brackets.
11. Disconnect the coolant temperature wiring sensor located on the water pump.
12. Loosen the lower radiator hose clamp and the two heater hose clamps at the water pump. Coolant will generally still pour out of the hoses and water pump.
13. To remove the water pump, the power steering pump may need to be removed. With a shorter extension, the water pump bolt should be able to be accessed. There are six water pump bolts. Once again, more coolant may spill out.
14. At this point, you should be able to access the distributor cap! Mark the location of each spark plug wire before removing them.
15. Remove the vacuum lines (if equipped) and the distributor connector at the distributor and on the passenger side of the intake manifold (Figure 6).
16. Using the supplied special tool and a 1/4" wrench, remove the four screws that hold the distributor cap to the engine

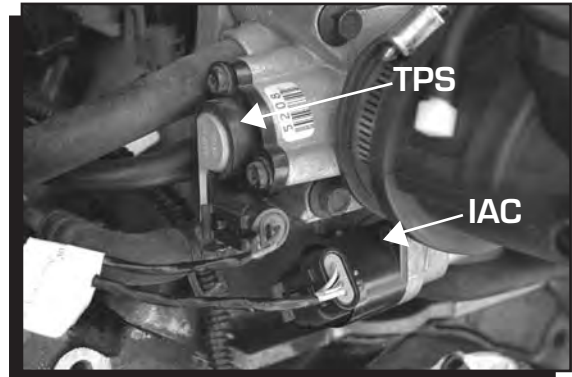
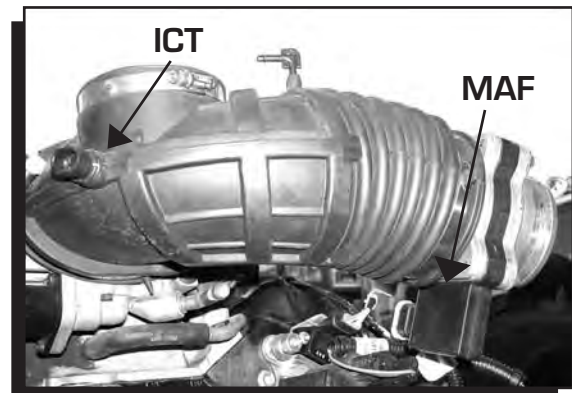
**Figure 3 Disconnect TPS and IAC.****Figure 4 Disconnect the MAF and ICT.****Figure 5 Removing the Hub.****Figure 6 Disconnect the Distributor Connector.****Figure 7 Removing the Original Cap.**

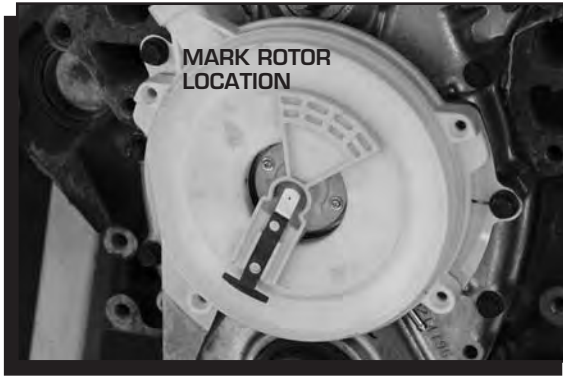

Figure 8 Rotor Location.



Figure 9 Removing the Distributor.

and pull the cap off (Figure 7). Mark the location of the rotor. This will help ensure the proper location of the new distributor (Figure 8).

17. Remove the three bolts that secure the distributor to the front cover (Figure 9).
18. Notice the indexing pin on the camshaft (Figure 10). Be sure to align the new distributor with the pin on the cam. The rotor should come to rest in the same location as it did in Figure 8.
19. Install the new Distributor (Figure 11). Use the supplied socket head hex screws.
20. Install the square O-ring seal on the billet housing. Use care not to twist or kink the seal (Figure 12).
21. Install the cap and tighten the five screws evenly.
22. Route the new wiring harness to the top of the intake and plug in the connector (Figure 13).
23. Connect the fresh air lines to the top and bottom inlets on the distributor. The MSD Distributor has the fresh air inlet on the top of the housing. (See Figure 14).
24. Reinstall the components in the reverse order. It is recommended to follow along with your vehicle's Service Manual.
25. Install the spark plug wires ensuring they are routed to the correct terminal (Figure 15).

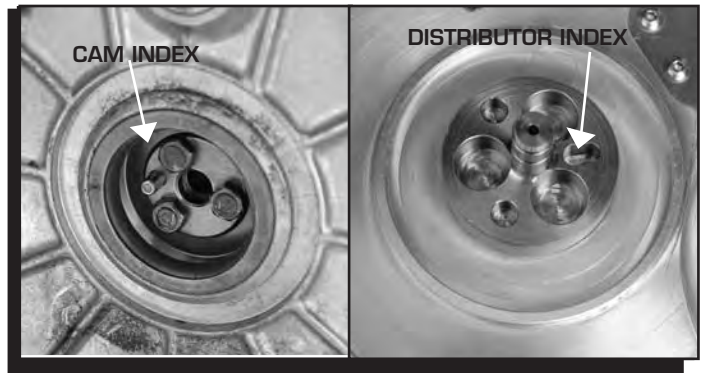

Figure 10 Indexing the Cam and Distributor.



Figure 11 Installing the New Distributor.

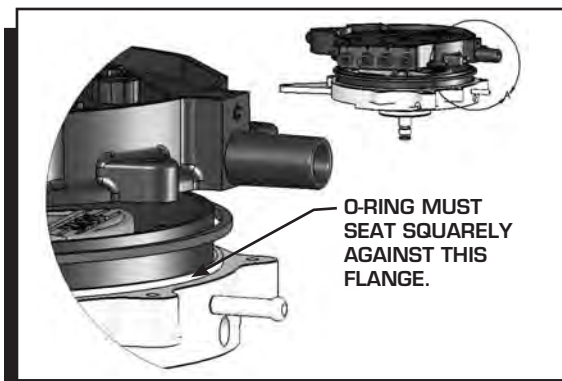

Figure 12 Installing the O-Ring and Cap.



Figure 13 Distributor Connector.

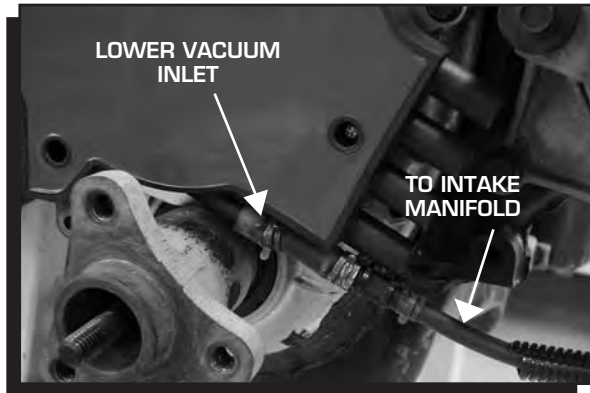

Figure 14 Install the Lower Vacuum Line.

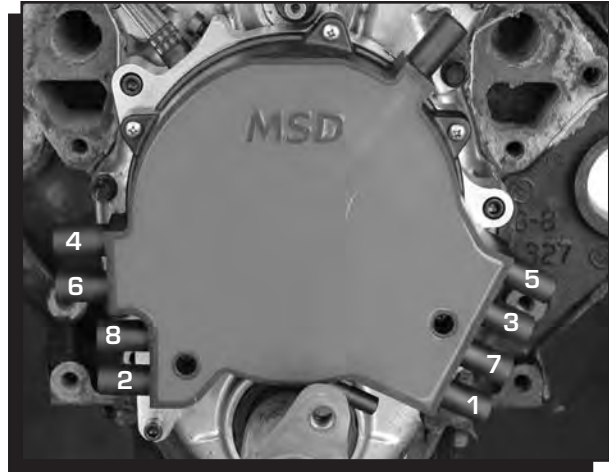

Figure 15 Plug Wire Routing.

TECH NOTES

Service

In case of malfunction, this MSD component will be repaired free of charge according to the terms of the warranty. When returning MSD components for warranty service, **Proof of Purchase** must be supplied for verification. After the warranty period has expired, repair service is based on a minimum and maximum fee.

All returns must have a Return Material Authorization (RMA) number issued to them before being returned. To obtain an RMA number please contact MSD Customer Service at 1 (888) MSD-7859 or visit our website at www.msdisignition.com/rma to automatically obtain a number and shipping information.

When returning the unit for repair, leave all wires at the length in which you have them installed. Be sure to include a detailed account of any problems experienced, and what components and accessories are installed on the vehicle. The repaired unit will be returned as soon as possible using Ground shipping methods (ground shipping is covered by warranty). For more information, call MSD Ignition at (915) 855-7123. MSD technicians are available from 7:00 a.m. to 5:00 p.m. Monday - Friday (mountain time).

Limited Warranty

MSD IGNITION warrants this product to be free from defects in material and workmanship under its intended normal use*, when properly installed and purchased from an authorized MSD dealer, for a period of one year from the date of the original purchase. This warranty is void for any products purchased through auction websites. If found to be defective as mentioned above, it will be repaired or replaced at the option of MSD Ignition. Any item that is covered under this warranty will be returned free of charge using Ground shipping methods.

This shall constitute the sole remedy of the purchaser and the sole liability of MSD Ignition. To the extent permitted by law, the foregoing is exclusive and in lieu of all other warranties or representation whether expressed or implied, including any implied warranty of merchantability or fitness. In no event shall MSD Ignition or its suppliers be liable for special or consequential damages.

*Intended normal use means that this item is being used as was originally intended and for the original application as sold by MSD Ignition. Any modifications to this item or if it is used on an application other than what MSD Ignition markets the product, the warranty will be void. It is the sole responsibility of the customer to determine that this item will work for the application they are intending. MSD Ignition will accept no liability for custom applications.