

# MSD<sup>®</sup> IGNITION INSTALLATION INSTRUCTIONS

## MSD Start/Retard Control PN 8982

**IMPORTANT:** Read the instructions before attempting installation.

### Parts Included:

1 - Start/Retard Control, PN 8982  
4 - Retard Modules, 0°, 2°, 3°, 4°  
1 - Wiring Kit

4 - Mounting Screws  
4 - Mounting Pads and Sleeves

**WARNING:** During installation disconnect the battery cables. When disconnecting the battery, always remove negative cable first and install it last.

**Note:** The PN 8982 must be used with an MSD Ignition Control.

## OPERATION

The Start/Retard Control provides a start retard and a high speed retard. Figure 1 shows the timing and operation of the Control. In the example, the total timing is set at 35°. During cranking and through approximately 1,300 rpm, the Start Retard is programmed to remove 10°. At 4,000 rpm, the High Speed Retard is activated and the timing is retarded 4° (adjustable with plug-in modules).

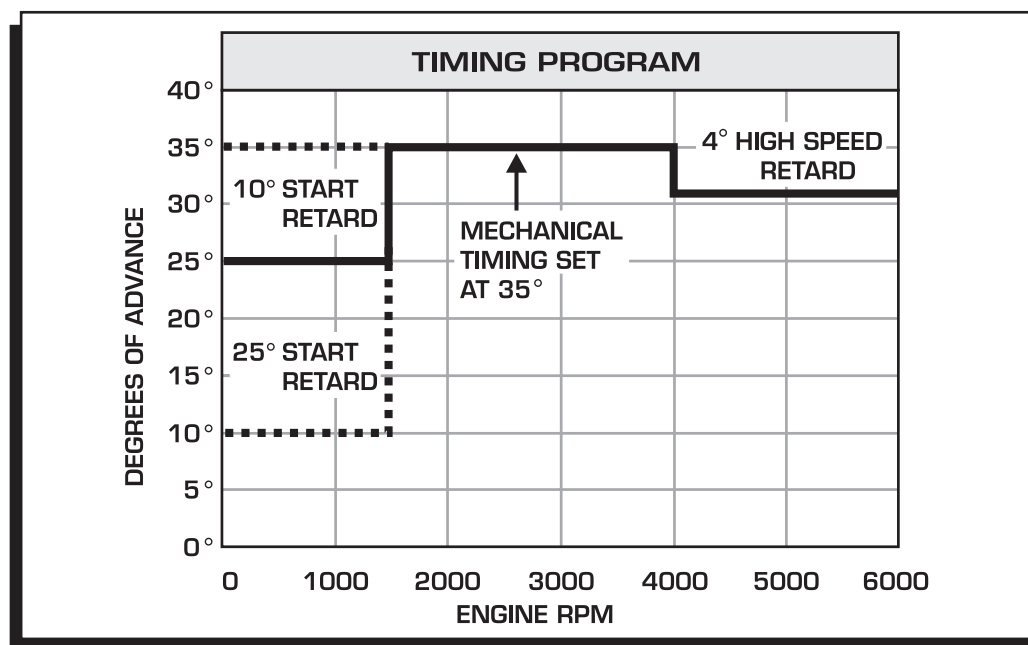

Figure 1 Operation of the Start/Retard Control.

## PROGRAMMING

### CYLINDER PROGRAMMING

The Start/Retard Control is programmed at the factory for 8-cylinder engines. It can easily be modified for use on 4 and 6-cylinder engines. Figure 2 shows the Cylinder Programming Loops and how to modify the unit.

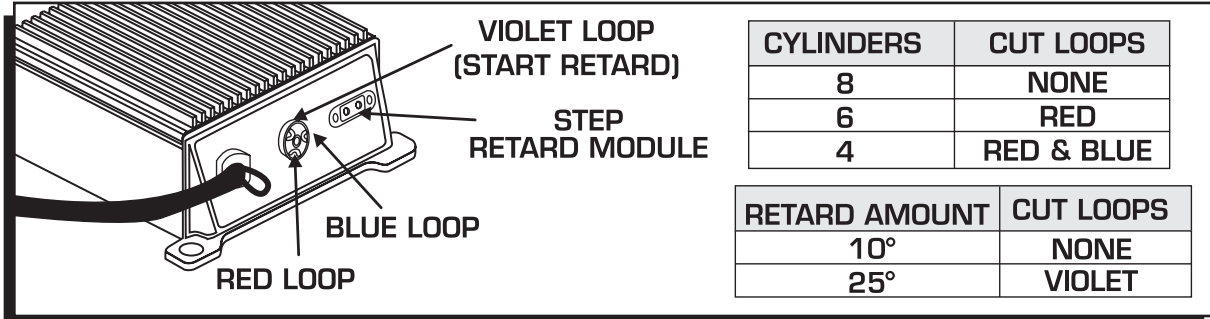

Figure 2 Programming the Start/Retard Control.

### START RETARD PROGRAMMING

The Start/Retard function is set up at the factory to retard the timing 10° when activated. It can easily be modified to retard 25° if desired. To receive the 25° retard, cut the Violet wire loop as shown in Figure 2.

### MOUNTING

The Start/Retard Control can be mounted under the hood, but should be away from direct engine heat sources. Make sure that the wiring reach their connections. Before mounting the unit, install the supplied mounting pads. Push the rubber pad in place from the top. Insert the sleeve from the bottom with the flared side down (Figure 3). Use the unit as a template to mark the mounting holes. Remove the unit and drill the holes with an 1/8" drill bit. Use the supplied screws to mount the unit.

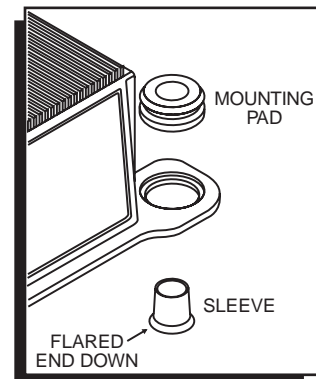

Figure 3 Installing Mounting Pads.

WIRING	
<b>RED</b>	This is the On/Off wire. Connects to switched 12 volts.
<b>BLACK</b>	Connects to Ground.
<b>YELLOW</b>	Trigger output. Connects to the MSD Ignition's White Wire.
TRIGGER INPUTS	
There are two input trigger circuits. <b>The wires will never be connected at the same time.</b>	
<b>WHITE</b>	Connects to points or the amplifier trigger wire.
<b>GREEN/VIOLET 2-Pin Connector</b>	Connects to the magnetic pickup of the distributor or crank trigger. Green is negative, Violet is positive.
STEP CONTROL WIRES	
<b>Note:</b> If the Step Retard is not going to be used, the Gray wire <b>must be grounded</b> or a Zero degree module must be installed. If not, the max retard amount (20°) will be applied.	
<b>VIOLET</b>	This wire activates the Start Retard when <b>applied to 12 volts</b> .
<b>GRAY</b>	This wire activates the Step Retard when it is <b>removed from ground</b> .

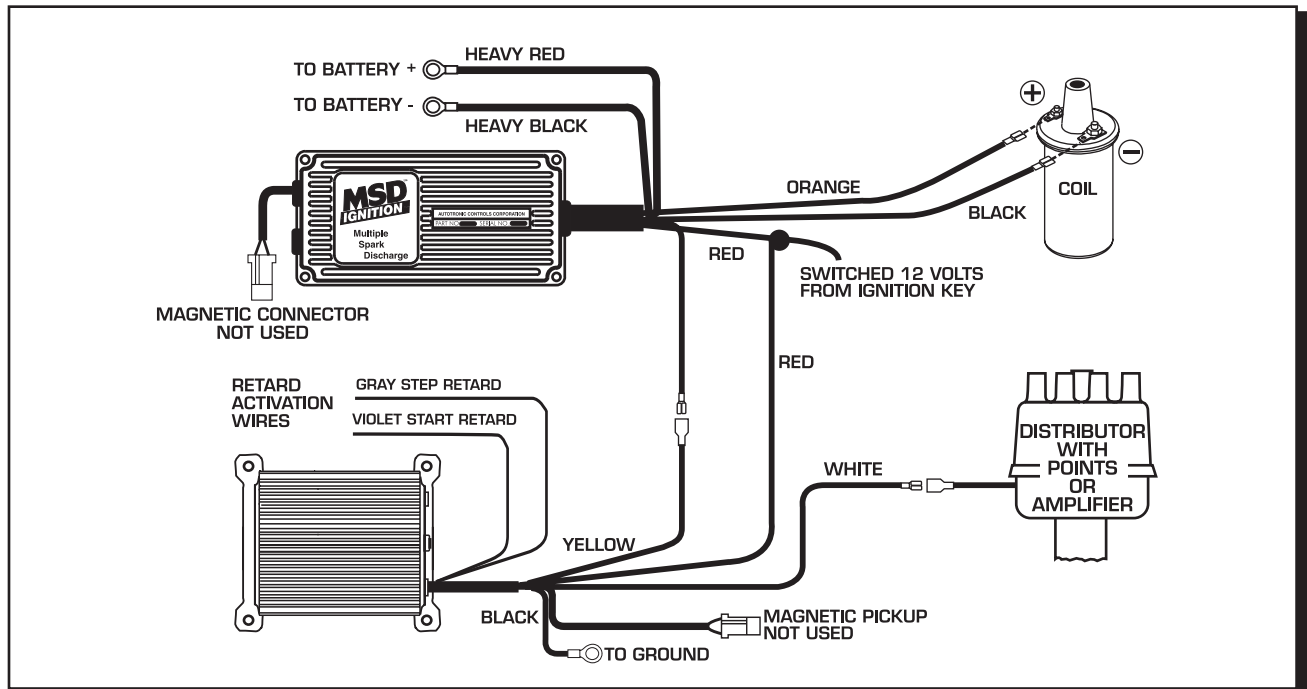

Figure 4 Wiring an MSD 6 Series Ignition with Points/Amplifier.

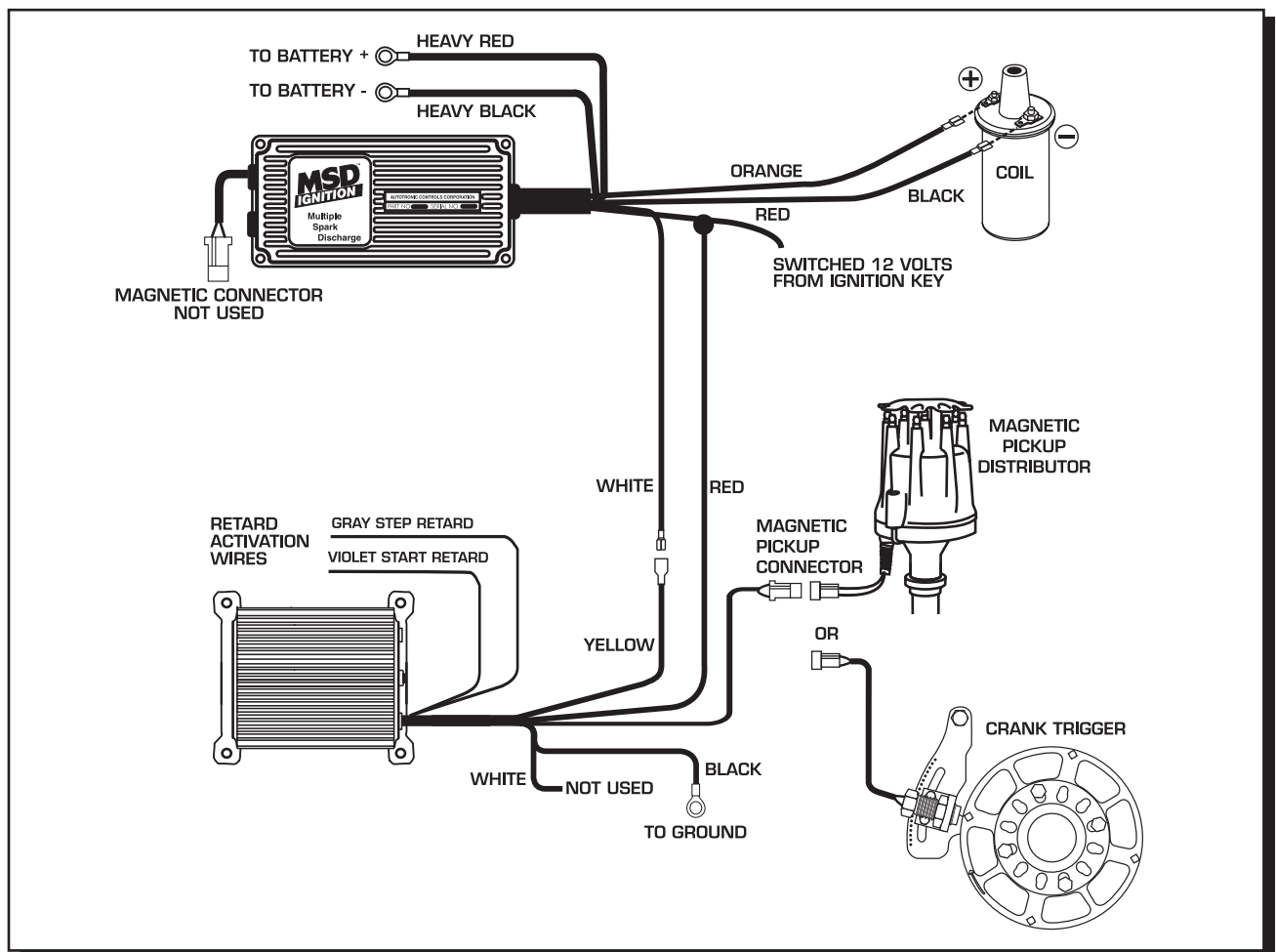

Figure 5 Wiring an MSD 6 Series Ignition with a Mag Pickup.

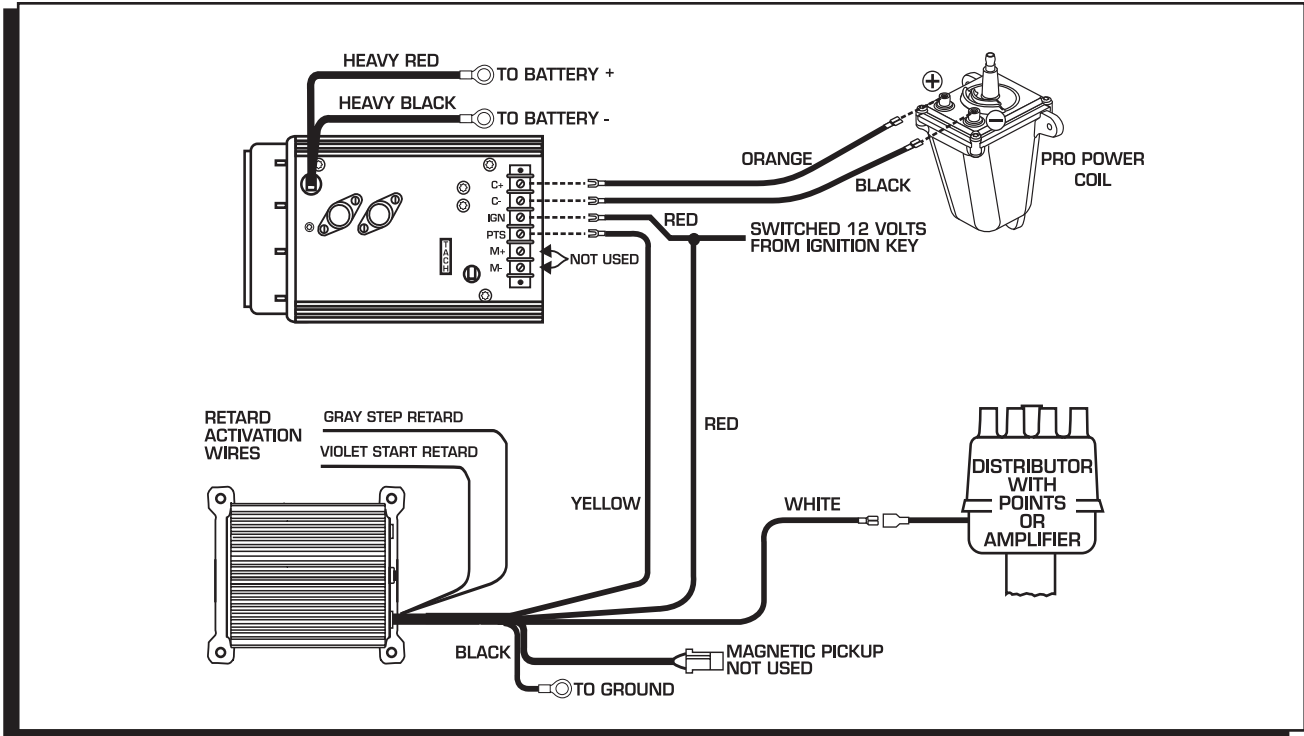

Figure 6 Wiring an MSD 7 Series Ignition with Points/Amplifier.

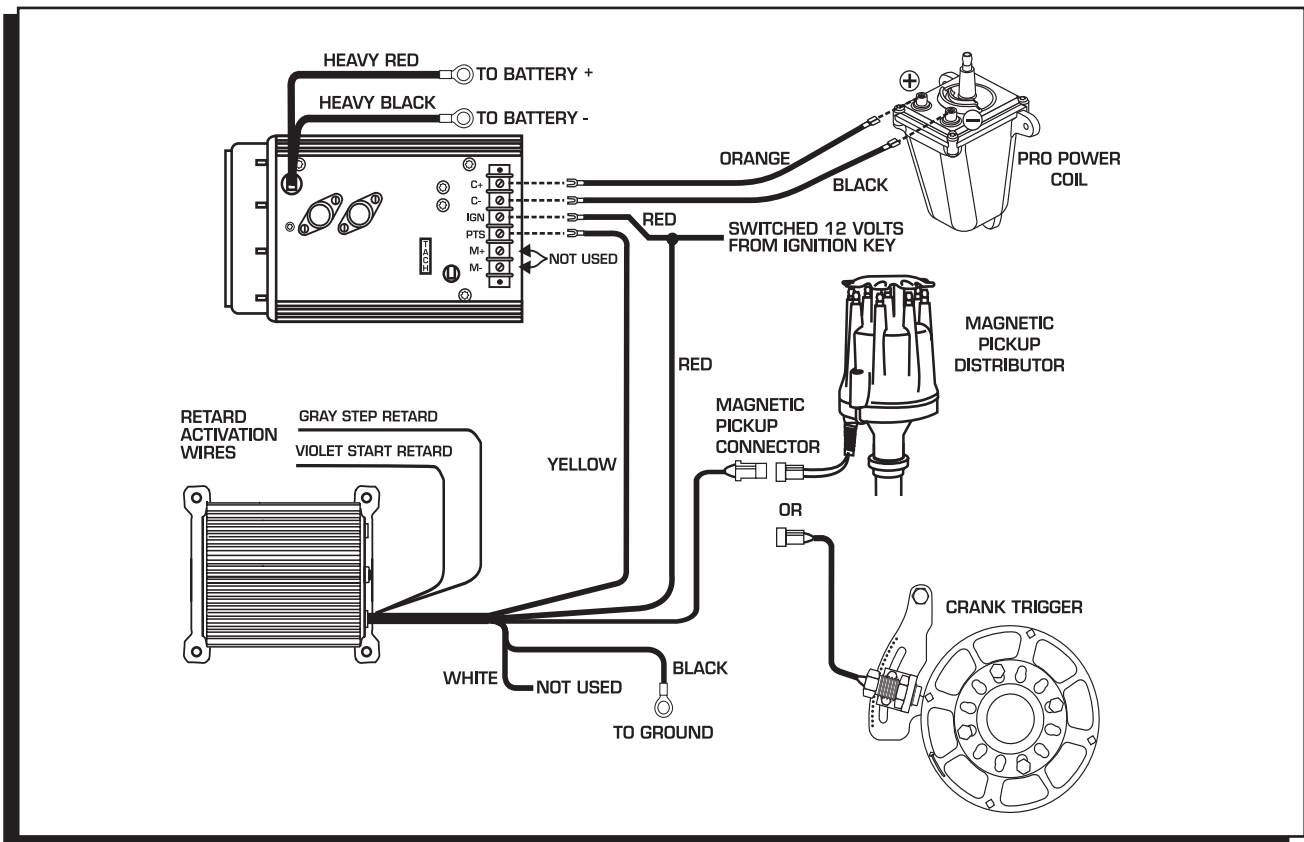

Figure 7 Wiring an MSD 7 Series Ignition with a Mag Pickup.

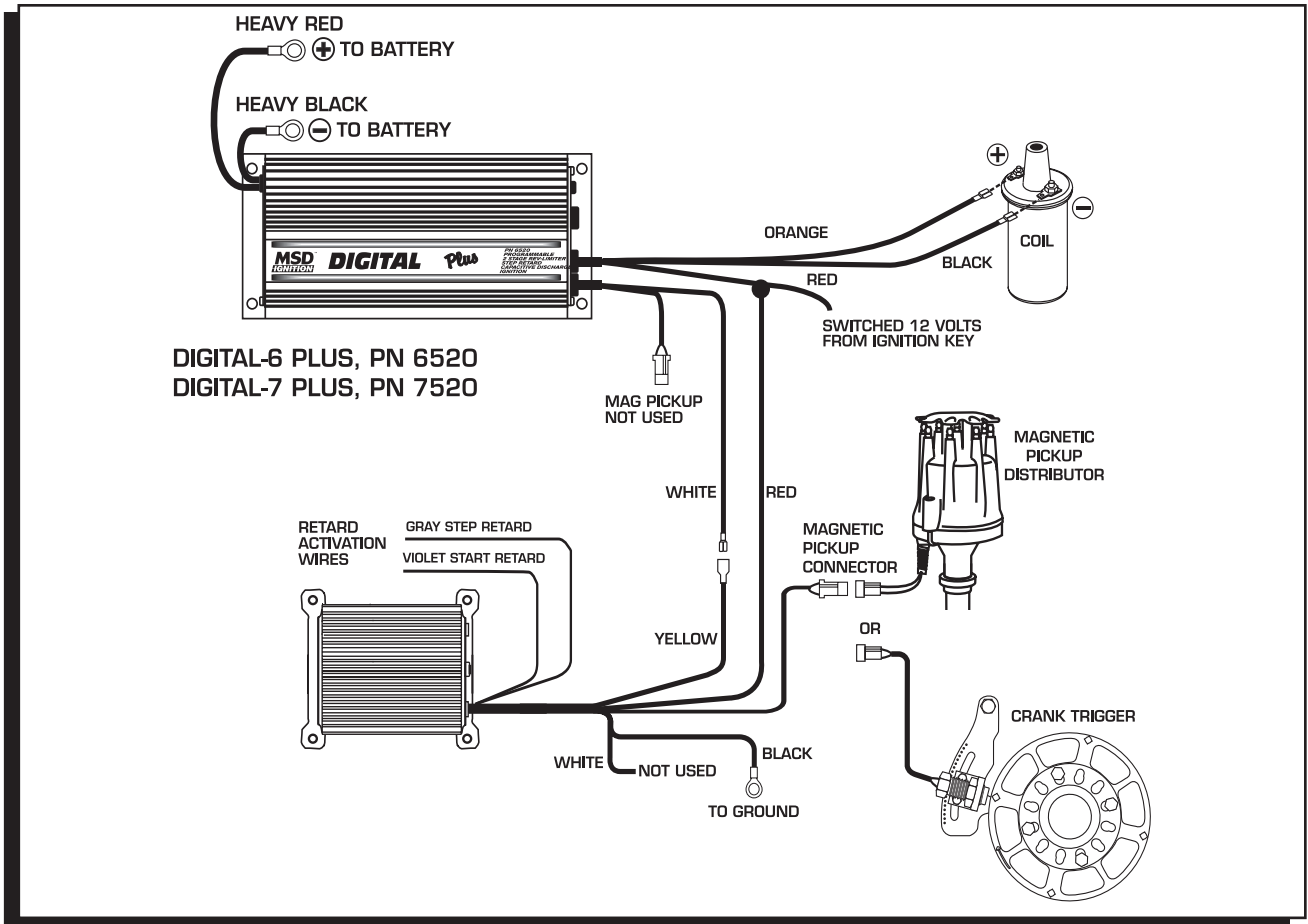

Figure 8 Wiring a Digital 6-Plus or 7-Plus Ignition with a Mag Pickup.

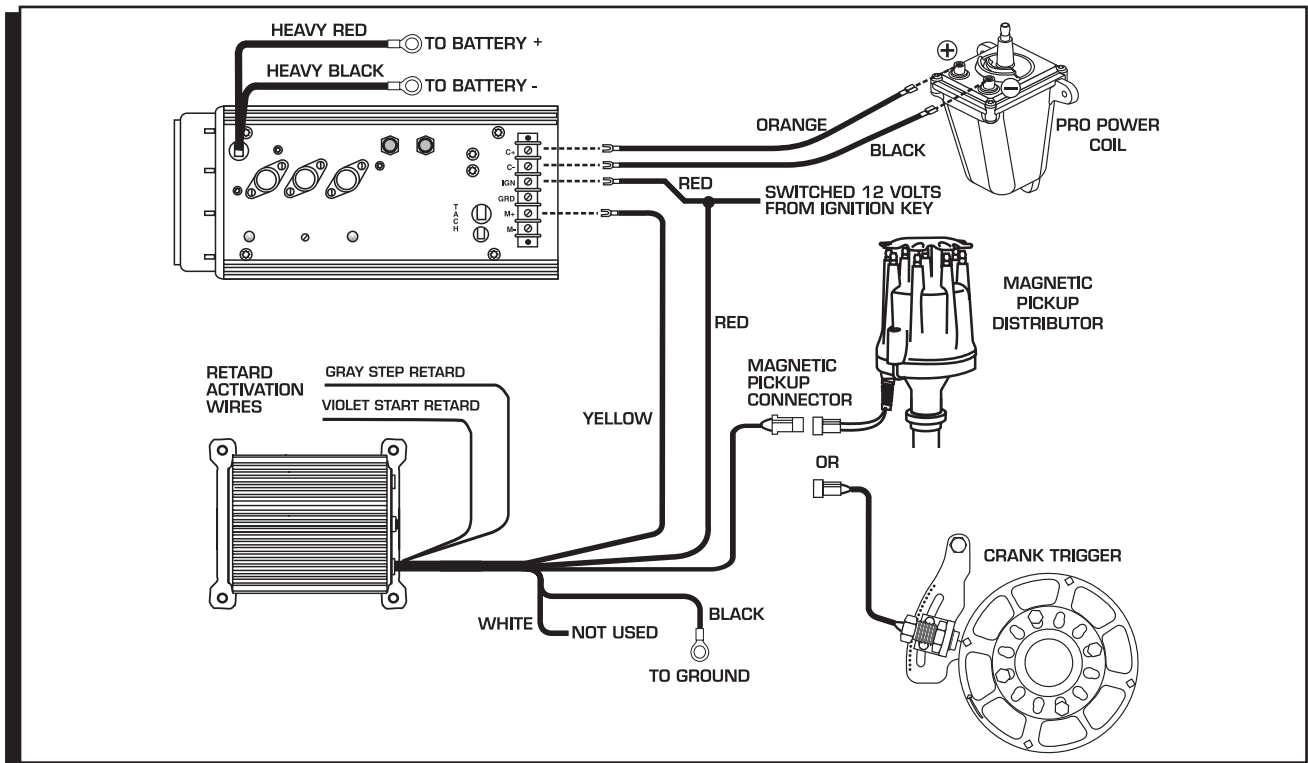

Figure 9 Wiring to an MSD 8 with a Mag Pickup.

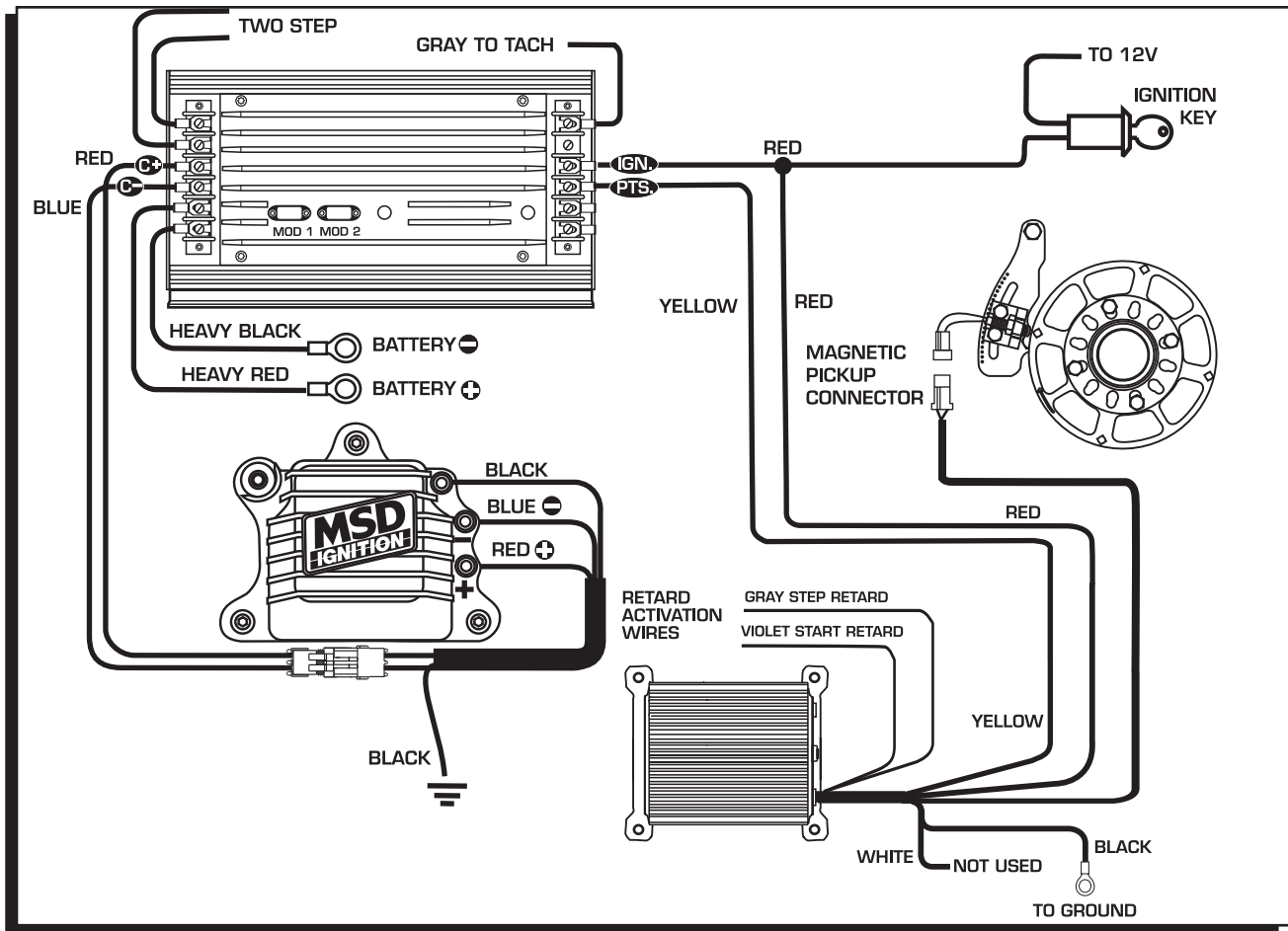

Figure 10 Wiring an MSD 10 PLUS with a Mag Pickup.

## START RETARD

The Violet wire is responsible for the Start Retard circuit. When activated, the Start Retard function will retard the timing  $10^\circ$  or  $25^\circ$  while the engine is cranking (see Programming page 2). The retard function will only operate until the engine reaches 1,300 rpm. After 1,300 rpm the Start Retard cannot be activated unless the key is turned Off. There are two different ways to connect this function (Figure 11):

### A. Constant 12 Volts

In this setup, whenever the ignition is turned On, 12 volts is applied and the retard function is activated. The retard will be deactivated when the engine reaches approximately 1,300 rpm and will not occur again until the ignition is turned **Off** (or if the engine drops below 400 rpm). Connect the Violet wire to a switched 12 volt source.

### B. Cranking Only

In this setup, the timing is retarded only when the engine is cranking. Connect the Violet wire directly to the starter solenoid. When the key is turned to the Crank position, 12 volts is applied to the Violet wire, activating the retard. When the key is released, 12 volts is removed and the timing returns to your run timing.

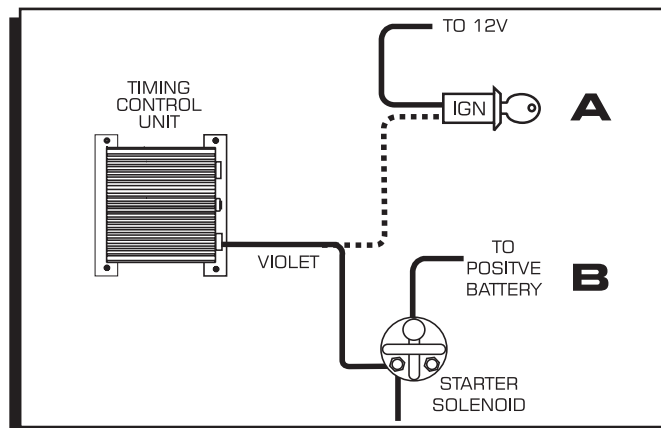

Figure 11 Wiring the Start Retard Function.

**HIGH SPEED RETARD**

The High Speed Retard function is activated by the Gray wire. When ground is **removed** from the Gray wire, the Retard is activated (Figure 12).

**Note:** If a retard is not going to be used, the Gray wire **must** be grounded or a Zero degree module **must** be installed. If there is not a module installed and the Gray wire is not grounded, max retard (20°+) will be applied.

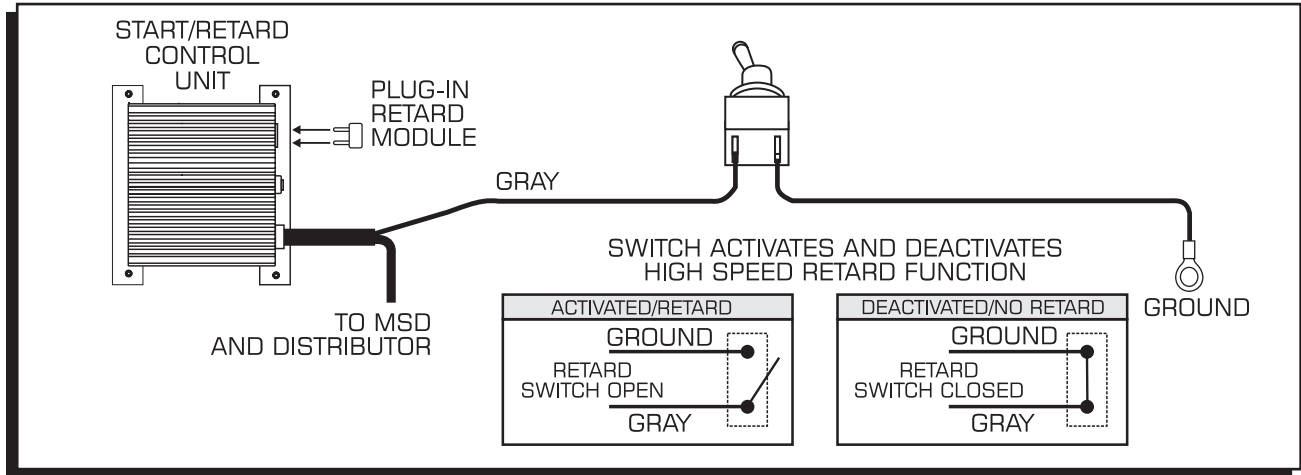

Figure 12 Connecting the High Speed Start/Retard using a Switch.

**ACTIVATING THE RETARD THROUGH A NITROUS SOLENOID**

The Retard can be activated at the same time as a nitrous solenoid. Connect the Gray wire to the 12 volt side of the nitrous solenoid (Figure 13). With no voltage present, the Gray wire is grounded through the windings of the solenoid. When 12 volts is applied, the ground is removed and the Retard is activated.

**Note:** This is not recommended with Progressive nitrous systems.

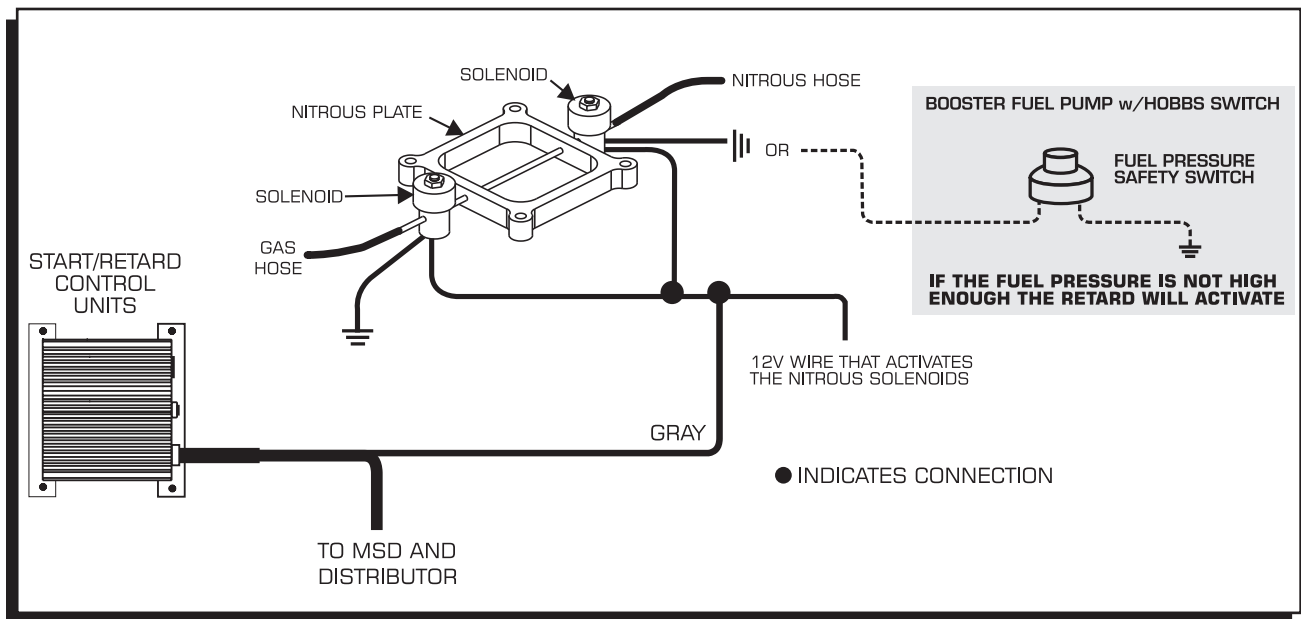
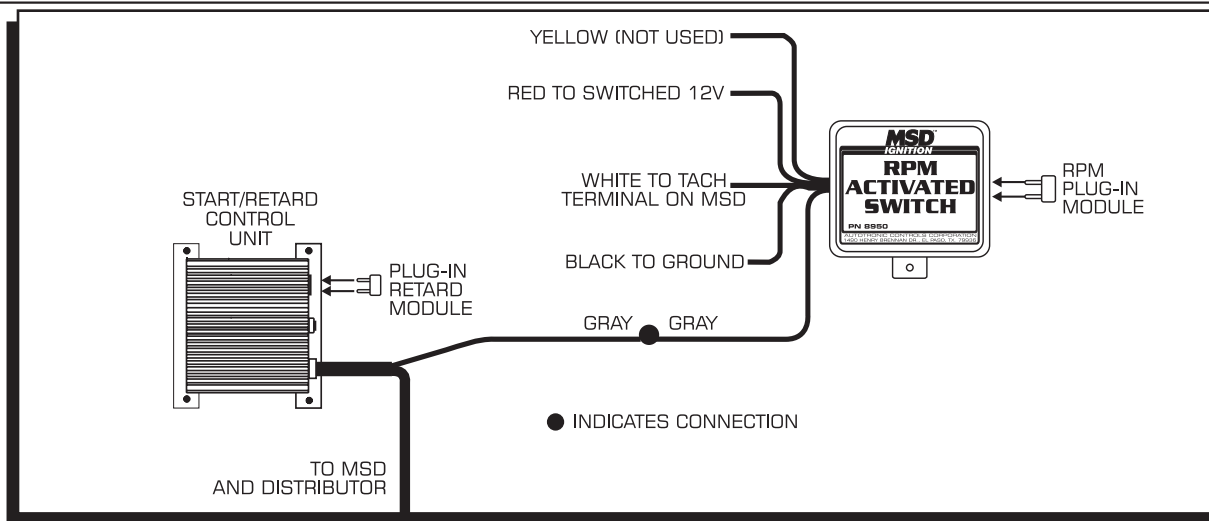

Figure 13 Connecting the High Speed Retard to a Nitrous Solenoid.



**Figure 14 Activating the High Speed Retard with an RPM Activated Switch.**

### Retard Module Kits

1° - 5°	PN 8777
6° - 10°	PN 8776
11° - 15°	PN 8774
16° - 20°	PN 8775

### Retard Selectors

0° - 11°	PN 8676
0°/10° - 20°	PN 8677

Selectors provide 11 different retard amounts with the turn of a knob.

**Additional Retard Modules are available separately.**

### Service

In case of malfunction, this MSD component will be repaired free of charge according to the terms of the warranty. When returning MSD components for warranty service, **Proof of Purchase** must be supplied for verification. After the warranty period has expired, repair service is based on a minimum and maximum fee.

**All returns must have a Return Material Authorization (RMA) number** issued to them before being returned. To obtain an RMA number please contact MSD Customer Service at 1 (888) MSD-7859 or visit our website at [www.msdisignition.com/rma](http://www.msdisignition.com/rma) to automatically obtain a number and shipping information.

When returning the unit for repair, leave all wires at the length in which you have them installed. Be sure to include a detailed account of any problems experienced, and what components and accessories are installed on the vehicle. The repaired unit will be returned as soon as possible using Ground shipping methods (ground shipping is covered by warranty). For more information, call MSD Ignition at (915) 855-7123. MSD technicians are available from 7:00 a.m. to 6:00 p.m. Monday - Friday (mountain time).

### Limited Warranty

MSD IGNITION warrants this product to be free from defects in material and workmanship under its intended normal use\*, when properly installed and purchased from an authorized MSD dealer, for a period of one year from the date of the original purchase. This warranty is void for any products purchased through auction websites. If found to be defective as mentioned above, it will be repaired or replaced at the option of MSD Ignition. Any item that is covered under this warranty will be returned free of charge using Ground shipping methods.

This shall constitute the sole remedy of the purchaser and the sole liability of MSD Ignition. To the extent permitted by law, the foregoing is exclusive and in lieu of all other warranties or representation whether expressed or implied, including any implied warranty of merchantability or fitness. In no event shall MSD Ignition or its suppliers be liable for special or consequential damages.

\*Intended normal use means that this item is being used as was originally intended and for the original application as sold by MSD Ignition. Any modifications to this item or if it is used on an application other than what MSD Ignition markets the product, the warranty will be void. It is the sole responsibility of the customer to determine that this item will work for the application they are intending. MSD Ignition will accept no liability for custom applications.