

# LoadLIFTER™ 5000

by AIR LIFT®

## Kit 57349

*Ford F-450*

*2 & 4 Wheel Drive*



## INSTALLATION GUIDE

For maximum effectiveness and safety, please read these instructions completely before proceeding with installation.

*Failure to read these instructions can result in an incorrect installation.*



# TABLE OF CONTENTS

<b>Installation Diagram</b> .....	<b>2</b>
Hardware List .....	3
Tools List .....	3
<b>Introduction</b> .....	<b>4</b>
Important Safety Notice .....	4
Notation Explanation .....	4
<b>Installing the LoadLifter 5000 System</b> .....	<b>5</b>
Getting Started .....	5
Assembling the Air Springs .....	7
Installing the Assemblies .....	11
Installing the Heat Shield .....	13
<b>Installing the Air Lines</b> .....	<b>14</b>
Tips for Installing Air Lines .....	15
<b>Finished Installation Photos</b> .....	<b>16</b>
<b>Before Operating</b> .....	<b>17</b>
Checking for Leaks .....	17
Fixing Leaks .....	17
Installation Checklist .....	18
Post-Installation Checklist .....	18
<b>Product Use, Maintenance and Servicing</b> .....	<b>19</b>
Minimum and Maximum Pressure .....	19
Maintenance Guidelines .....	19
Tuning the Air Pressure .....	20
Guidelines for Adding Air .....	20
<b>Troubleshooting Guide</b> .....	<b>21</b>
Frequently Asked Questions .....	21
<b>Limited Warranty and Returns Policy</b> .....	<b>22</b>
<b>Replacement Part Information</b> .....	<b>23</b>
<b>Contact Information</b> .....	<b>23</b>

# Installation Diagram

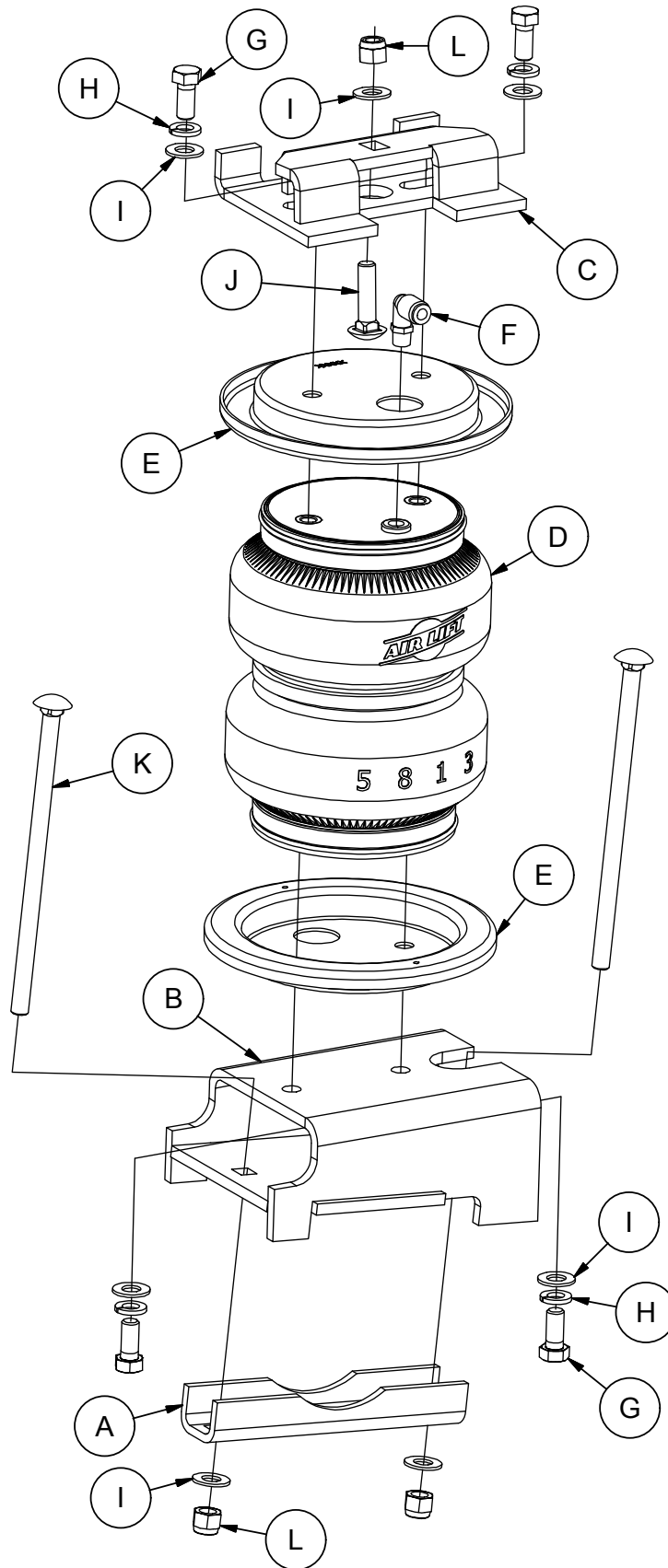


fig. 1

**HARDWARE LIST**

Item	Part #	Description.....Qty	Item	Part #	Description.....Qty
A	01531	Clamp bar .....2	AA*	20086	Air line assembly.....1
B	03108	Lower bracket .....2	BB*	10466	Tie strap .....6
C	07984	Upper bracket .....2	CC*	21230	Valve cap .....2
D	58437	Air spring.....2	DD*	18501	5/16" flat washer .....2
E	11951	Roll plate.....4	EE*	21234	Rubber washer.....2
F	21837	90° swivel fitting .....2	FF*	18411	Star washer.....2
G	17203	3/8"-24 x 7/8" hex head bolt.....8	GG*	21233	5/16" hex nut.....4
H	18427	3/8" lock washer.....8			
I	18444	3/8" flat washer .....14			
J	17156	3/8"-16 x 1.5" long carriage bolt.....2			
K	17163	3/8"-16 x 7.0" long carriage bolt.....4			
L	18435	3/8"-16 nylon lock nut.....6			

\*Not shown in fig. 1.

**TOOLS LIST**

Description..... Qty	Description..... Qty
Hoist or floor jacks ..... 1	Metric and standard sockets..... 1
Safety stands..... 2	5/16" drill bits (very sharp)..... 1
Safety glasses ..... 1	Heavy duty drill ..... 1
Torque wrench..... 1	Hose cutter, razor blade, or sharp knife ..... 1
Standard open-end combo wrenches..... 1	Air compressor or compressed air source..... 1
Ratchet ..... 1	Spray bottle with dish soap/water solution ..... 1



Missing or damaged parts? Call Air Lift customer service at (800) 248-0892 for a replacement part.

# Introduction

The purpose of this publication is to assist with the installation, maintenance and troubleshooting of the LoadLifter 5000 air spring kit. LoadLifter 5000 utilizes sturdy, reinforced, commercial grade single or double, depending on the kit, convolute bellows. The bellows are manufactured like a tire with layers of rubber and cords that control growth. LoadLifter 5000 Ultimate kits are recommended for most 3/4- and 1-ton pickups and SUVs with leaf springs and provide up to 5,000 pounds of load leveling support with air adjustability from 5-100 PSI. The kits are also used in motor home rear kits and some motor home fronts where leaf spring are used.

It is important to read and understand the entire installation guide before beginning installation or performing any maintenance, service or repair. The information here includes a hardware list, tool list, step-by-step installation information, maintenance guidelines and operating tips.

Air Lift Company reserves the right to make changes and improvements to its products and publications at any time. For the latest version of this manual, contact Air Lift Company at **(800) 248-0892** or visit [airliftcompany.com](http://airliftcompany.com).

## IMPORTANT SAFETY NOTICE

The installation of this kit does not alter the gross vehicle weight rating (GVWR) or payload of the vehicle. Check your vehicle's owner's manual and do not exceed the maximum load listed for your vehicle.

**Gross vehicle weight rating:** The maximum allowable weight of the fully loaded vehicle (including passengers and cargo). This number — along with other weight limits, as well as tire, rim size and inflation pressure data — is shown on the vehicle's Safety Compliance Certification Label.

**Payload:** The combined, maximum allowable weight of cargo and passengers that the truck is designed to carry. Payload is GVWR minus the base curb weight.

## NOTATION EXPLANATION

Hazard notations appear in various locations in this publication. Information which is highlighted by one of these notations must be observed to help minimize risk of personal injury or possible improper installation which may render the vehicle unsafe. Notes are used to help emphasize areas of procedural importance and provide helpful suggestions. The following definitions explain the use of these notations as they appear throughout this guide.



**DANGER**

INDICATES IMMEDIATE HAZARDS WHICH WILL RESULT IN SEVERE PERSONAL INJURY OR DEATH.



**WARNING**

INDICATES HAZARDS OR UNSAFE PRACTICES WHICH COULD RESULT IN SEVERE PERSONAL INJURY OR DEATH.



**CAUTION**

INDICATES HAZARDS OR UNSAFE PRACTICES WHICH COULD RESULT IN DAMAGE TO THE MACHINE OR MINOR PERSONAL INJURY.

## NOTE

*Indicates a procedure, practice or hint which is important to highlight.*

# Installing the LoadLifter 5000 System

## GETTING STARTED

### DANGER

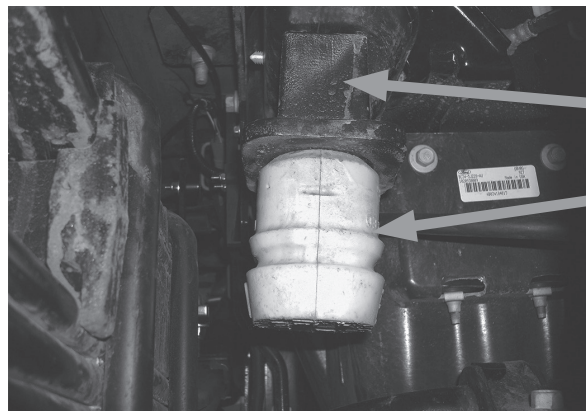
COMPRESSED AIR CAN CAUSE INJURY AND DAMAGE TO THE VEHICLE AND PARTS IF IT IS NOT HANDLED PROPERLY. FOR YOUR SAFETY, DO NOT TRY TO INFLATE THE AIR SPRINGS UNTIL THEY HAVE BEEN PROPERLY SECURED TO THE VEHICLE.

1. Raise the vehicle and support it in some way, using jack stands or equivalent, so that the axle can be dropped safely away from the frame. This will need to be done in order for the air spring assembly to be put into position between the axle and frame (fig. 2). Figure 2 shows the frame being supported with the vehicle on a drive on hoist.



*fig. 2*

2. In order to install the kit, it will be necessary to remove the stock jounce bumpers and mounting brackets from under the frame rails on both sides of the vehicle (fig. 3).

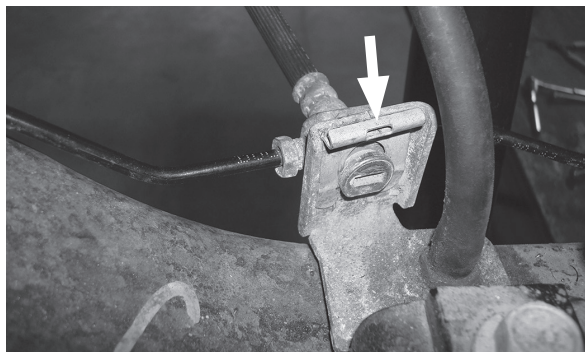


Stock jounce bumper

Mounting bracket

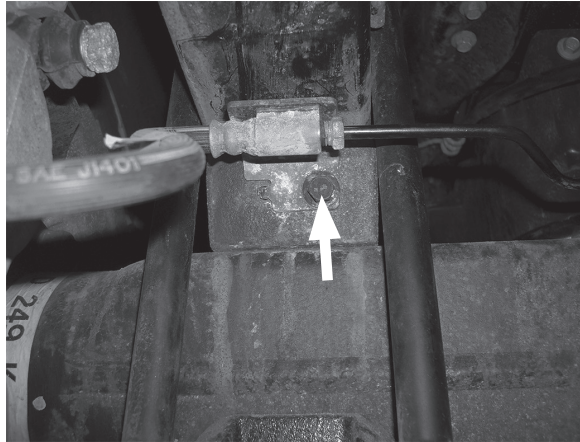
*fig. 3*

3. It will be necessary to temporarily remove the vent/brake line junction block on the driver side from the axle bracket (fig. 4). Do this by pulling the clip off the front side of the junction block and pull it back to remove it from the bracket.

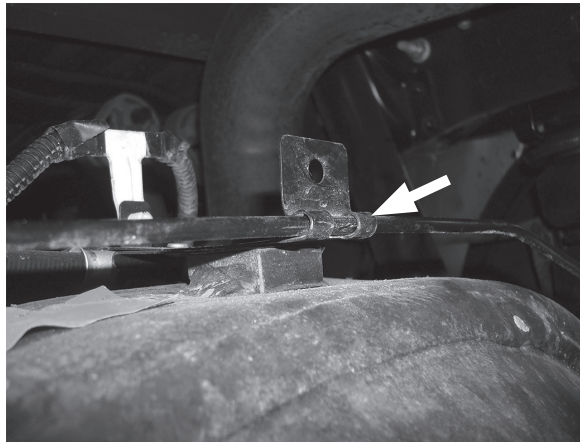


*fig. 4*

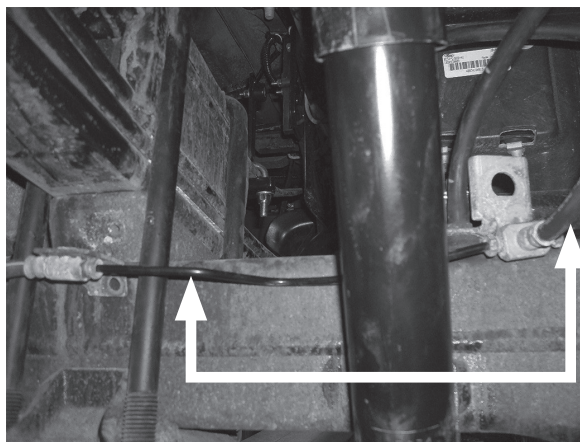
4. Remove the bolt from the brake line bracket that is attached to the spring perch (fig. 5).

*fig. 5*

5. Unclip the brake line from the bracket on top of the differential (fig. 6).

*fig. 6*

6. Pull the brake line back away from the axle to make room for placing the air spring assembly, on the driver side, into position (fig. 7).

*fig. 7*



## ASSEMBLING THE AIR SPRING ASSEMBLIES

1. Set a roll plate (E) on top of the air spring (D). The radiused or rounded edge of the roll plate will be towards the air spring so that it is seated inside the roll plate (fig. 8). Install the 90° swivel fitting (F) into the top of the air spring, finger tight plus one and a half turns.

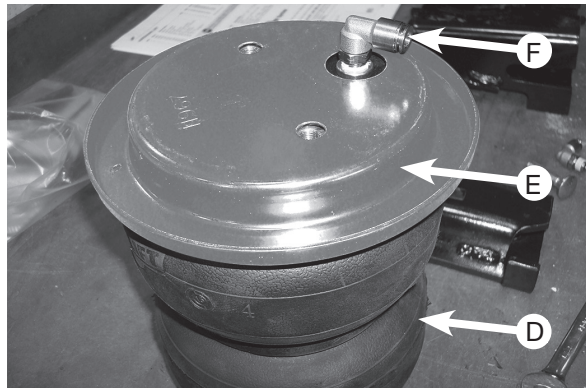


fig. 8

2. Insert the 3/8"-16 X 1.5" carriage bolts (J) through both upper brackets (C) as shown (fig. 9).

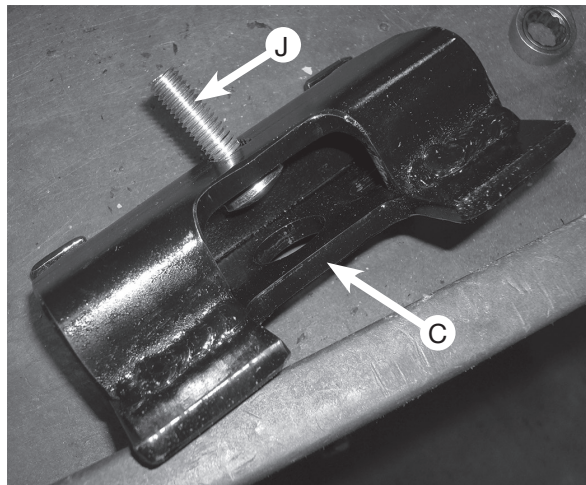


fig. 9

Set the brackets on both air spring assemblies and attach with 3/8"-16 X 7/8" hex cap screws (G), 3/8" lock washers (H) and 3/8" flat washers (I). Leave loose at this time (fig. 10). Figure 11 shows the upper air spring assembly.

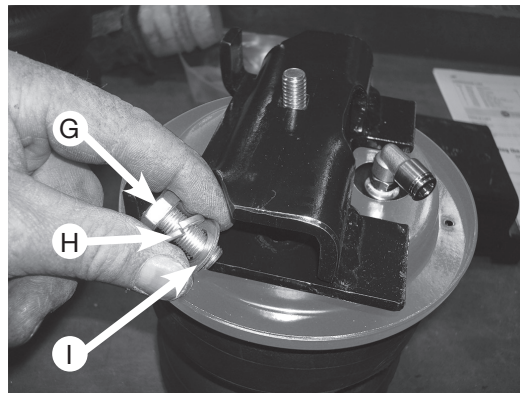


fig. 10

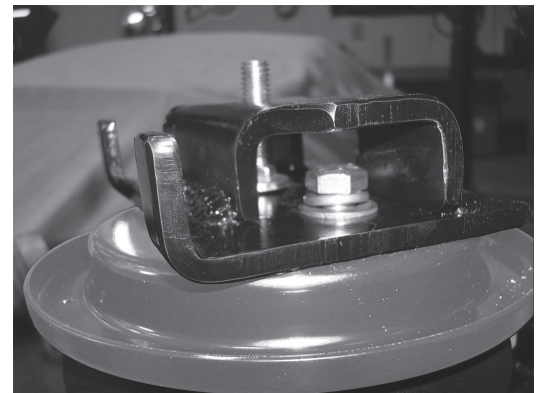
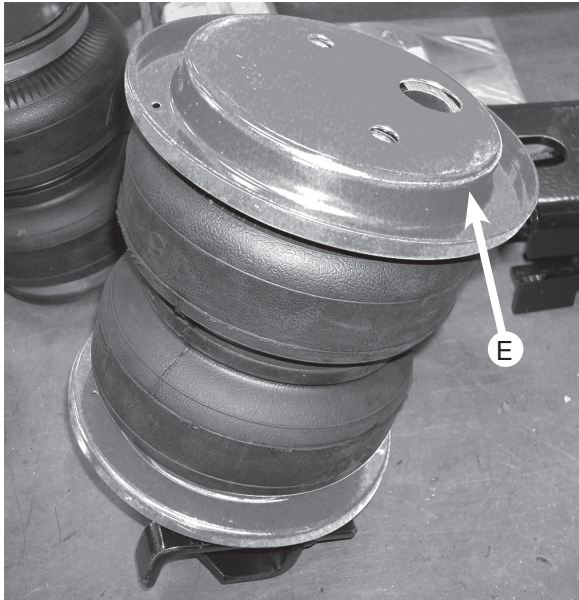
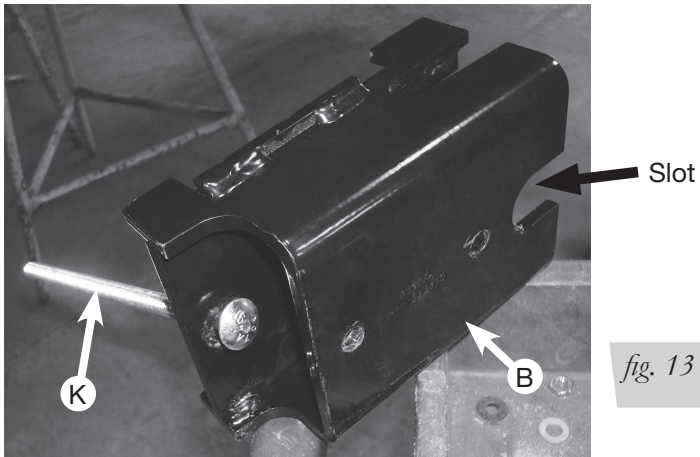


fig. 11

4. Flip the air spring assemblies upside down and set a roll plate (E) over the bottom of each air spring (fig. 12). The radiused or rounded edge of the roll plate will be towards the air spring so that the air spring is seated inside the roll plate.

*fig. 12*

5. Insert the 3/8"-16 X 7" carriage bolts (K) through the lower bracket (B) hole that is opposite of the slot shown in figure 13. Repeat for both lower brackets.

*fig. 13*

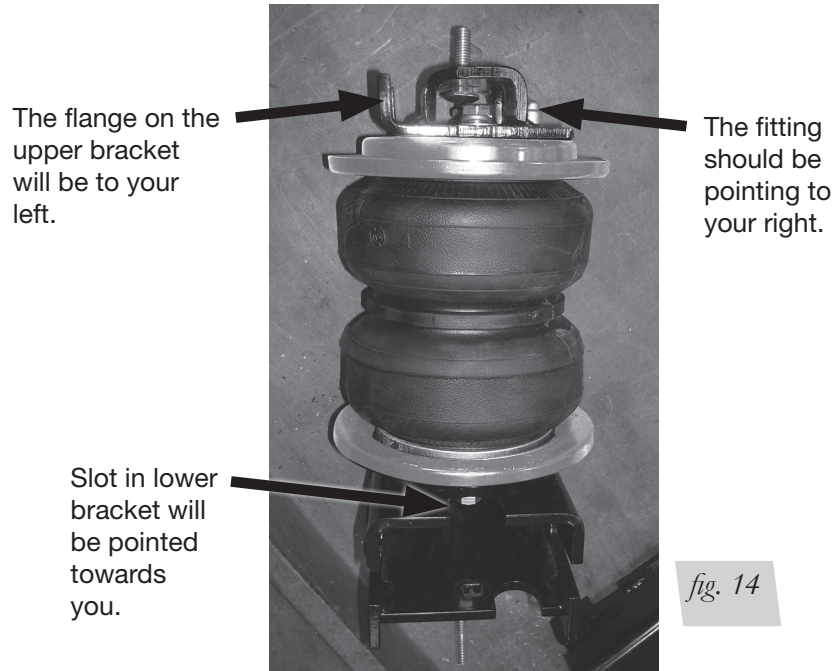
- When setting the lower bracket onto the air spring assemblies, you will be setting up both a left and a right hand assembly. Assemble the right hand (passenger) assembly as shown in figure 14. Assemble the left (driver) side air spring assembly by rotating the air spring assembly 180°.

**NOTE**

*The slot in the lower bracket will face the rear of the vehicle and the fittings will be to the outside of the frame when installed onto the vehicle.*

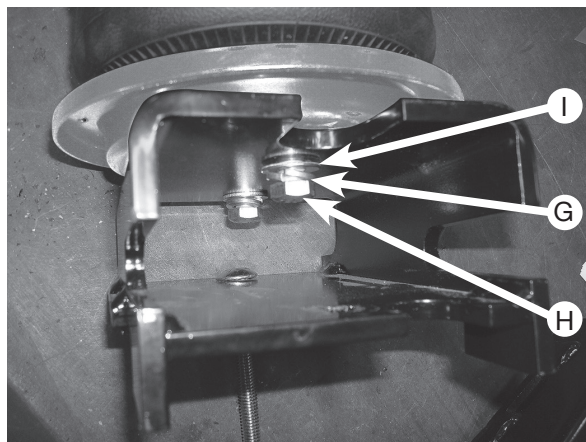
**The Right (Passenger) side is shown.**

Rotate the air spring assembly 180° to create the left (driver) side assembly.



*fig. 14*

- Attach the lower bracket (B) to the air spring assemblies with the 3/8"-16 X 7/8" hex cap screws (G), 3/8" lock washers (H) and 3/8" flat washer (I) and tighten to no more than 20 lb.-ft. (fig. 15).

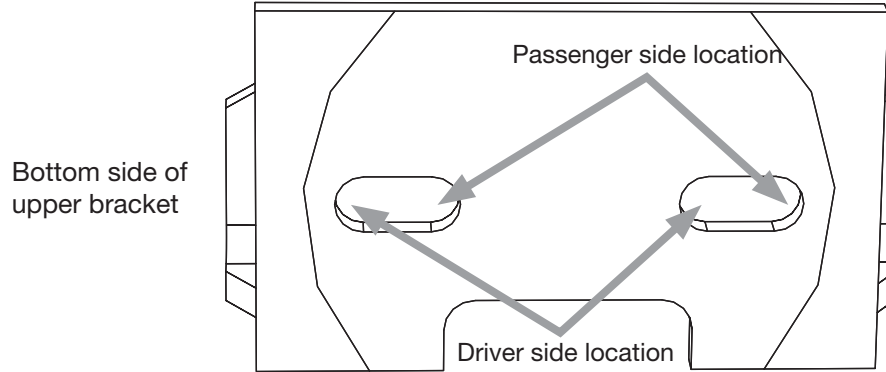


*fig. 15*

- The upper bracket (C) has two slots for mounting to the air spring and will be specific to which side the assembly is mounted. Figure 16 shows the upper bracket and the correct holes to use for the left (driver) and right (passenger) side installations. Torque the mounting hardware to no more than 20 lb.-ft.

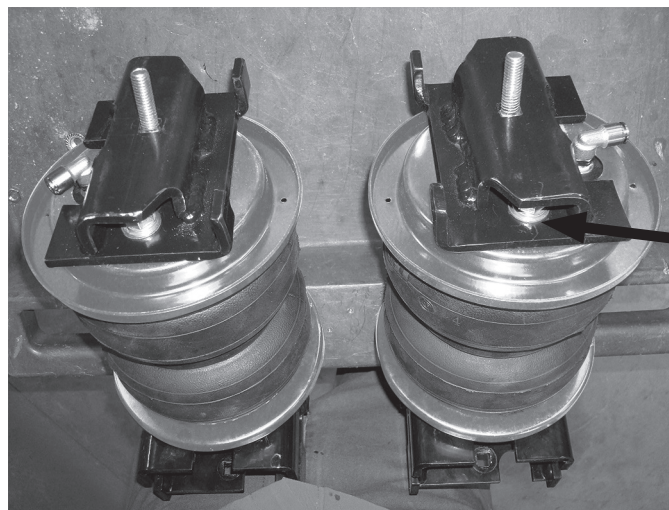
**NOTE**

*With the assembly put into position on the axle, the bracket must be forward of the air spring, fully in the slot. The mounting bolts will be to the rear of the assembly.*



*fig. 16*

- Figure 17 shows the completed left (driver) and right (passenger) side assemblies.



Note the upper mounting bolts to the rear of the slots in the upper brackets on the assemblies.

*fig. 17*

Left (Driver) side assembly

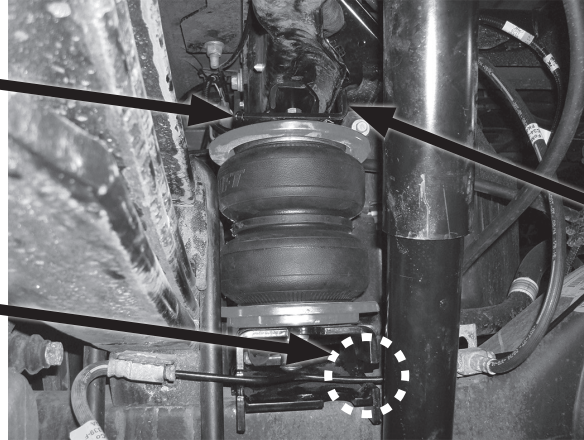
Right (Passenger) side assembly

## INSTALLING THE ASSEMBLIES

1. Set the left and right hand assemblies onto the axle. Make sure the brake line that was un-bolted on the left (driver) side is clear while positioning the assembly. Raise the axle or lower the frame so that the upper bracket carriage bolts go through the existing jounce bumper holes in the bottom of the frame. Also, make sure that the flanges on the upper bracket fit on the inside of the lower frame flange (Figs. 18 and 19).

The fitting is facing toward the outside of the vehicle frame

Make sure brake line is clear when positioning assembly into position on driver side.

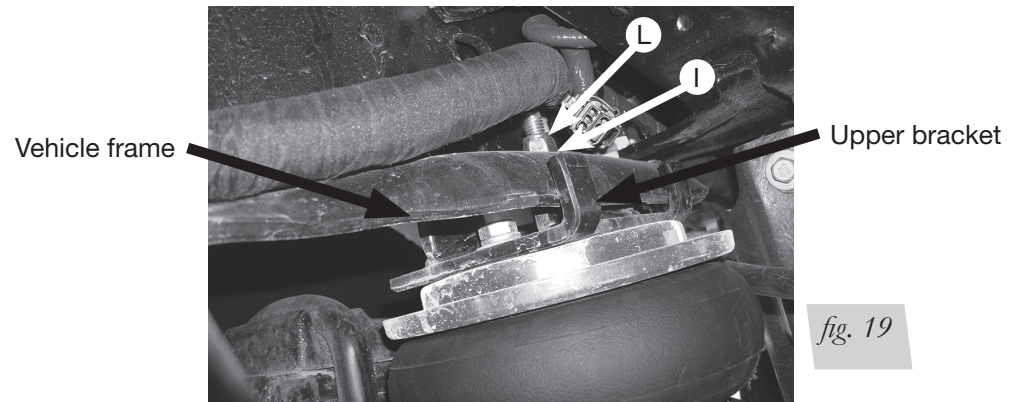


**Left (Driver) side shown**

Make sure the flange on the upper bracket is on the inside of the lower frame flange as shown.

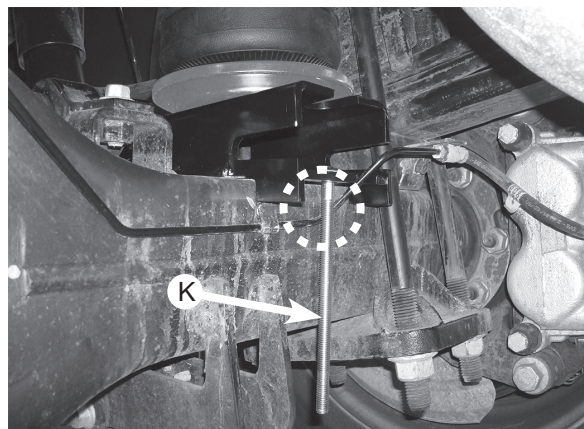
*fig. 18*

2. Cap the upper bracket's 3/8"-16 X 1.5" Carriage bolts (J) with a 3/8" Flat washer (I) and 3/8"-16 Nylon Lock Nut (L). Push the flange of the upper bracket outboard (against the frame) as far as it will go and torque the upper mounting hardware to 15 lb.-ft. (fig. 19). Repeat for the opposite side.



*fig. 19*

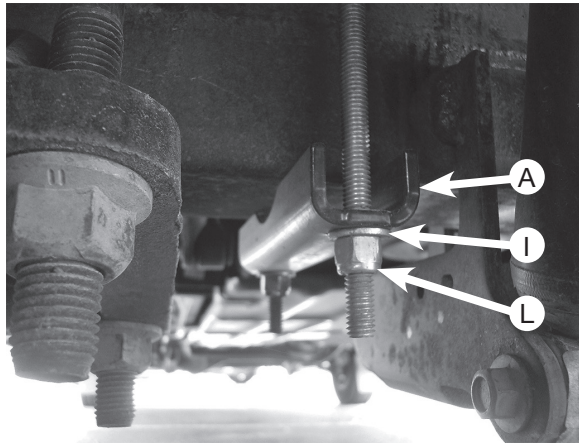
3. Insert the last two 3/8 -16 X 7" Carriage Bolts (K) into the last holes in the lower bracket behind the axle. Make sure the passenger side goes on the outside of the hard brake line as shown in figure 20.



**Right (Passenger) side shown**

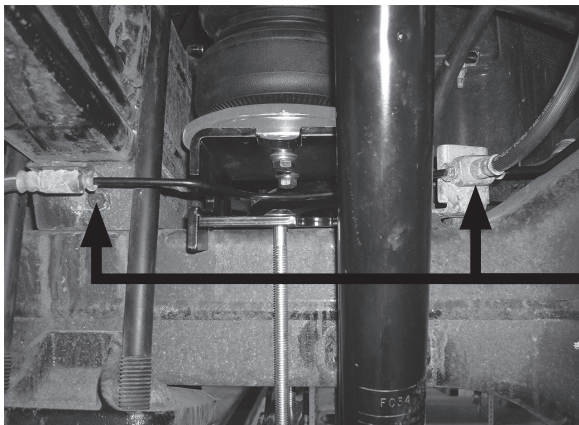
*fig. 20*

- Adjust the lower bracket/air spring assembly in and out on the axle to align the air spring as perpendicular to the upper bracket as possible. Install the Clamp Bar (A) over the long carriage bolts previously installed and cap with two 3/8" Flat Washers (I) and two 3/8"-16 Nylon Lock Nuts (L) (fig. 21). Torque both nuts evenly to 15 lb.-ft. Repeat for the other side.



*fig. 21*

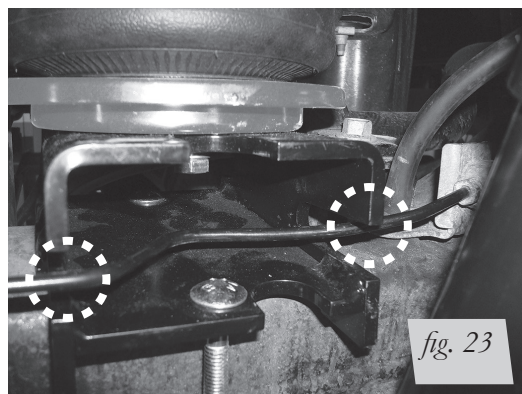
- Once the upper and lower brackets are tight, re-connect the brake line bracket to the spring perch using the stock bolt removed. Insert the brake line junction block back into the bracket on the axle and re-insert the clip that holds it in place. Clip the brake line back onto the bracket on top of the differential that was previously removed (figs. 6 and 22).



Re-attach the brake line brackets and holders back into position on the driver side that was previously removed.

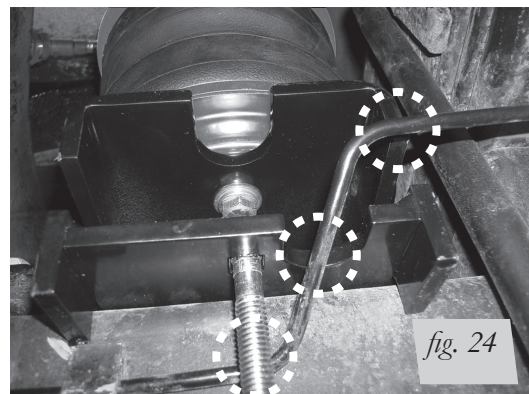
*fig. 22*

- The lower brackets have recesses in them to make clearance for the hard brake lines (figs. 23 and 24). If necessary, adjust the brake line so it is not rubbing on the lower bracket.



*fig. 23*

Hard brake line must not rub against the lower bracket as shown.



*fig. 24*

Hard brake line must not rub against the lower bracket or carriage bolt as shown.

## INSTALLING THE HEAT SHIELD

1. Bend the tabs on the heat shield to provide a 1/2" dead air space between exhaust pipe and heat shield (fig. 25).

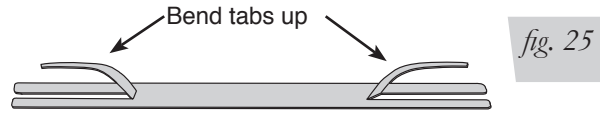


fig. 25

2. Attach the heat shield to the exhaust pipe using the clamps (fig. 26). Bend the heat shield for maximum clearance to the air spring.

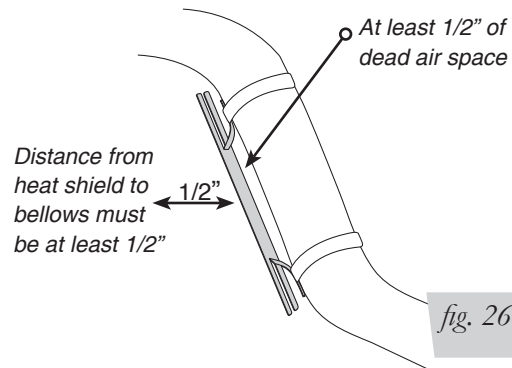


fig. 26

3. For vehicles with the large resonator on the rear exhaust, in order for the heat shield to be clamped onto the resonator, it will be necessary to double up on the clamps so they can go around it (fig. 27).

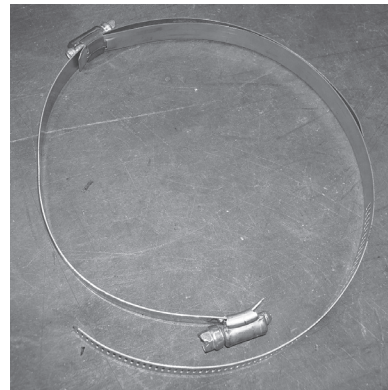


fig. 27

4. Once the tabs are bent correctly, attach the heat shield to the resonator or exhaust pipe as shown in figure 28.



fig. 28

# Installing the Air Lines

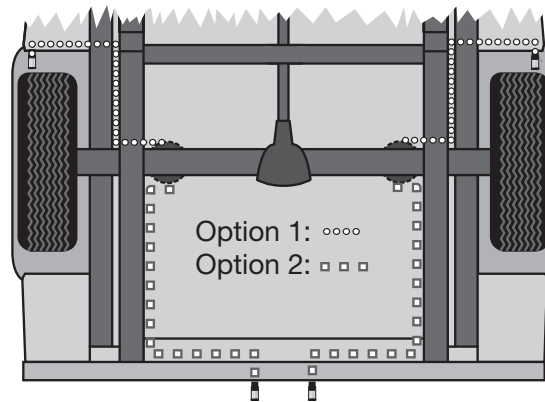
This section explains how to set up the air spring kit to be controlled with Schrader valves and a separate compressed air source. An on-board air compressor system allows for hassle-free control of the air springs. Learn more about Air Lift control systems at [www.airliftcompany.com/products/compressor-systems](http://www.airliftcompany.com/products/compressor-systems).

1. Choose a convenient location for mounting the inflation valves (Fig 29). Popular locations for the inflation valve are:
  - a. The wheel well flanges
  - b. The license plate recess in bumper
  - c. Under the gas cap access door
  - d. Through the license plate

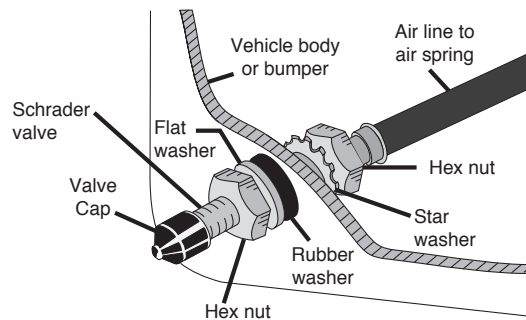
**NOTE**

*Whatever the chosen location, make sure there is enough clearance around the inflation valves for an air chuck.*

2. Drill 5/16" holes to install the inflation valves.


*fig. 29*

3. Cut the air line assembly in two equal lengths.
4. Place a 5/16" nut and star washer on the air valve. Leave enough of the inflation valve in front of the nut to extend through the hole and have room for the rubber washer, flat washer, and 5/16" nut and cap. There should be enough valve exposed after installation – approximately 1/2" – to easily apply a pressure gauge or an air chuck (Fig. 30).
5. Push the inflation valve through the hole and use the rubber washer, flat washer, and another 5/16" nut to secure it in place. Tighten the nuts to secure the assembly.


*fig. 30*



6. Route the air line along the frame to the fitting on the air spring (Fig. E.2). Keep AT LEAST 6" of clearance between the air line and the exhaust system. Avoid sharp bends and edges. Use plastic tie straps to secure the air line to fixed points along the chassis. Be sure that the tie straps are tight, but do not pinch the air line. Leave at least 2" of slack to allow for any movement that might pull on the air line.
7. Cut off the air line, leaving approximately 12" of extra air line. A clean square cut will prevent leaks. Insert the air line into the air fitting. This is a push-to-connect fitting. Simply push the air line into the 90° swivel fitting until it bottoms out (9/16" of air line should be in the fitting).

### TIPS FOR INSTALLING AIR LINES

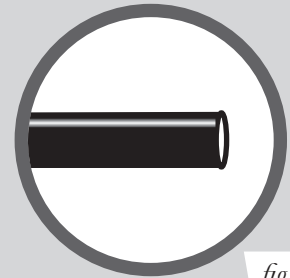
When cutting air lines, use a sharp knife or a hose cutter and make clean, square cuts (Fig. D.3). Do not use scissors or wire cutters because these tools may deform the air line, causing it to leak around fittings. Do not cut the lines at an angle.

Do not bend the 1/4" hose at a radius of less than 1" or bend the 3/8" hose at a radius of less than 1 1/2". Do not put side load pressure on fitting. The hose should be straight beyond the fitting for 1" before bending.

Inspect hose for scratches that run lengthwise on hose prior to installation. Contact Air Lift customer service at **(800) 248-0892** if the air line is damaged.



Go to [air-lift.co/cuttingairline](http://air-lift.co/cuttingairline) to watch a video demonstrating proper air line cutting.

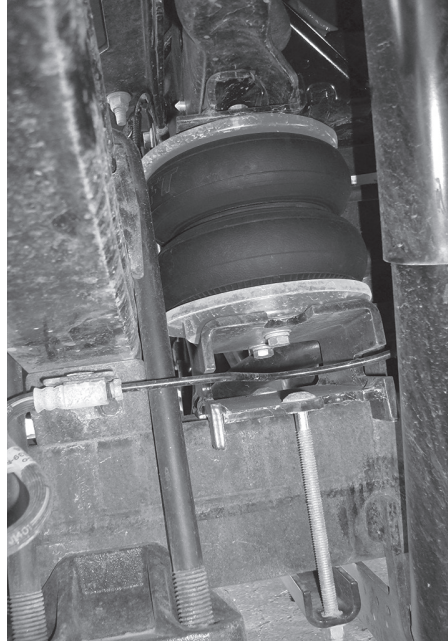


*fig. 31*



# Finished Installation Photos

1. Figure 32 shows the rear view of the left (driver) side installation. Figure 33 shows the inside, above axle view of the right (passenger) side installat



*fig. 32*

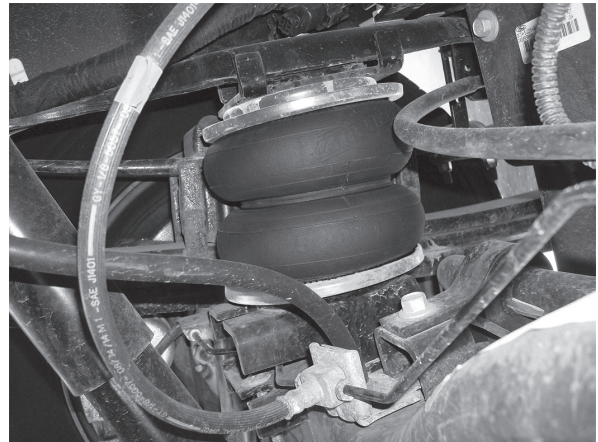


*fig. 33*

2. Figure 34 shows the rear view of the right (passenger) side installation. Figure 35 shows an inside view of the left (driver) side installation.



*fig. 34*



*fig. 35*

# Before Operating

## CHECKING FOR LEAKS

1. Inflate the air spring to 30 PSI.
2. Spray all connections and the inflation valves with a solution of 1/5 liquid dish soap and 4/5 water. Spot leaks easily by looking for bubbles in the soapy water.
3. After the test, deflate the springs to the minimum pressure required to restore the system to normal ride height. Do not deflate to lower than 5 PSI.
4. Check the air pressure again after 24 hours. A 2-4 PSI loss after initial installation is normal. Retest for leaks if the loss is more than 5 PSI.

## FIXING LEAKS

1. If there is a problem with the swivel fitting:
  - a. Check the air line connection by deflating the spring and removing the line by pulling the collar against the fitting and pulling firmly on the air line. Trim 1" off the end of the air line. Be sure the cut is clean and square (see Fig. E.4). Reinsert the air line into the push-to-connect fitting.
  - b. Check the threaded connection by tightening the swivel fitting another half turn. If it still leaks, deflate the air spring, remove the fitting, and re-coat the threads with thread sealant. Reinstall by hand tightening as much as possible and then use a wrench for an additional two turns.
2. If there is a problem with the inflation valve:
  - a. Check the valve core by tightening it with a valve core tool.
  - b. Check the air line by removing the air line from the barbed type fitting. Cut the air line off a few inches in front of the fitting and use a pair of pliers or vice grips to pull/twist the air line off of the fitting.



### CAUTION

DO NOT CUT OFF THE AIR LINE COMPLETELY AS THIS WILL USUALLY NICK THE BARB AND RENDER THE FITTING USELESS.

3. If the preceding steps have not resolved the problem, call Air Lift customer service at **(800) 248-0892**.

## INSTALLATION CHECKLIST

- Clearance test** — Inflate the air springs to 75-90 PSI and make sure there is at least 1/2" clearance from anything that might rub against each sleeve. Be sure to check the tire, brakes, frame, shock absorbers and brake cables.
- Leak test before road test** — Inflate the air springs to 75-90 PSI and check all connections for leaks. All leaks must be eliminated before the vehicle is road tested.
- Heat test** — Be sure there is sufficient clearance from heat sources, at least 6" for air springs and air lines. If a heat shield was included in the kit, install it. If there is no heat shield, but one is required, call Air Lift customer service at **(800) 248-0892**.
- Fastener test** — Recheck all bolts for proper torque.
- Road test** — The vehicle should be road tested after the preceding tests. Inflate the springs to recommended driving pressures. Drive the vehicle 10 miles and recheck for clearance, loose fasteners and air leaks.
- Operating instructions** — If professionally installed, the installer should review the operating instructions with the owner. Be sure to provide the owner with all of the paperwork that came with the kit.

## POST-INSTALLATION CHECKLIST

- Overnight leak down test** — Recheck air pressure after the vehicle has been used for 24 hours. If the pressure has dropped more than 5 PSI, then there is a leak that must be fixed. Either fix the leak yourself or return to the installer for service.
- Air pressure requirements** — It is important to understand the air pressure requirements of the air spring system. Regardless of load, the air pressure should always be adjusted to maintain adequate ride height at all times while driving.
- Thirty-day or 500-mile test** — Recheck the air spring system after 30 days or 500 miles, whichever comes first. If any part shows signs of rubbing or abrasion, the source should be identified and moved, if possible. If it is not possible to relocate the cause of the abrasion, the air spring may need to be remounted. If professionally installed, the installer should be consulted. Check all fasteners for tightness.

# Product Use, Maintenance and Servicing

Minimum Recommended Pressure	Maximum Air Pressure
5 PSI	100 PSI

## MAINTENANCE GUIDELINES

**NOTE**

*By following the steps below, vehicle owners will obtain the longest life and best results from their air springs.*



**CAUTION**

1. Check air pressure weekly.
  2. Always maintain normal ride height. Never inflate beyond 100 PSI.
  3. If you develop an air leak in the system, use a soapy water solution (1/5 liquid dish soap and 4/5 water) to check all air line connections and the inflation valve core before deflating and removing the air spring.
- FOR SAFETY AND TO PREVENT POSSIBLE DAMAGE TO THE VEHICLE, DO NOT EXCEED MAXIMUM GROSS VEHICLE WEIGHT RATING (GVWR), AS INDICATED BY THE VEHICLE MANUFACTURER. ALTHOUGH THE AIR SPRINGS ARE RATED AT A MAXIMUM INFLATION PRESSURE OF 100 PSI, THE AIR PRESSURE ACTUALLY NEEDED IS DEPENDENT ON LOAD AND GVWR.
4. Loaded vehicles require at least 25 PSI. A “loaded vehicle” refers to a vehicle with a heavy bed load, a trailer or both. Never exceed GVWR, regardless of air spring, air pressure or other load assist. The springs in this kit will support approximately 40 pounds of load (combined on both springs) for each 1 PSI of pressure. The required air pressure will vary depending on the state of the original suspension. Operating the vehicle below the minimum air spring pressure will void the Air Lift warranty.
  5. When increasing load, always adjust air pressure to maintain normal ride height. Increase or decrease pressure from the system as necessary to attain normal ride height for optimal ride and handling. Remember that loads carried behind the axle (including tongue loads) require more leveling force (pressure) than those carried directly over the axle.
  6. Always add air to springs in small quantities, checking the pressure frequently.
  7. Should it become necessary to raise the vehicle by the frame, make sure the system is at minimum pressure (5 PSI) to reduce the tension on the suspension/ brake components. Use of on-board leveling systems do not require deflation or disconnection.
  8. Periodically check the air spring system fasteners for tightness. Also, check the air springs for any signs of rubbing. Realign if necessary.
  9. On occasion, give the air springs a hard spray with a garden hose to remove mud, sand, gravel or other debris.

## TUNING THE AIR PRESSURE

Pressure determination comes down to three things — level vehicle, ride comfort and stability.

### 1. Level vehicle

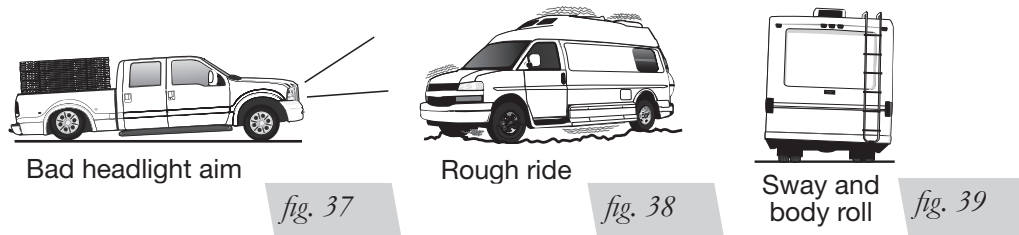
If the vehicle's headlights are shining into the trees or the vehicle is leaning to one side, then it is not level (Fig. 37). Raise the air pressure to correct either of these problems and level the vehicle.

### 2. Ride comfort

If the vehicle has a rough or harsh ride it may be due to either too much pressure or not enough (Fig. 38). Try different pressures to determine the best ride comfort.

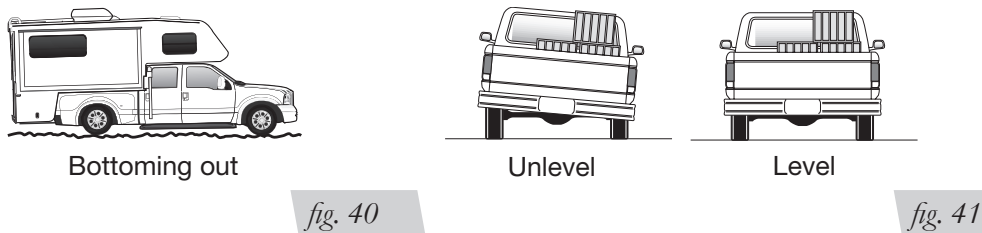
### 3. Stability

Stability translates into safety and should be the priority, meaning the driver may need to sacrifice a perfectly level and comfortable ride. Stability issues include roll control, bounce, dive during braking and sponginess (Fig. 39). Tuning out these problems usually requires an increase in pressure.



## GUIDELINES FOR ADDING AIR

1. Start with the vehicle level or slightly above.
2. When in doubt, always add air.
3. If the front of the vehicle dives while braking, increase the pressure in the front air bags, if equipped.
4. If it is ever suspected that the air bags have bottomed out, increase the pressure (Fig. 40).
5. Adjust the pressure up and down to find the best ride.
6. If the vehicle rocks and rolls, adjust the air pressure to reduce movement.
7. It may be necessary to maintain different pressures on each side of the vehicle. Loads such as water, fuel, and appliances will cause the vehicle to be heavier on one side (Fig. 41). As much as a 50 PSI difference is not uncommon.



# Troubleshooting Guide

PROBLEM	CAUSE	SOLUTION
System won't maintain pressure overnight.	Improperly installed air line, air line has holes or cracks.	Leak test the air line connections, the threaded connection into the air spring, and all fittings in the control system.
Air spring or tank leak.	Fitting seal or air line is compromised.	Check to make sure air lines are seated in connectors. Inspect fittings with soapy water. Trim hose or re-seal fitting. Ensure lines are cut straight.
Corner won't raise or air leak develops.	Look for a kink or fold in the air line.	Replace any air line that has been kinked.

## FREQUENTLY ASKED QUESTIONS

**Q. Will installing air springs increase the weight ratings of a vehicle?**

No. Adding air springs will not change the weight ratings (GAWR, GCWR and/or GVWR) of a vehicle. Exceeding the GVWR is dangerous and voids the Air Lift warranty.

**Q. Is it necessary to keep air in the air springs at all times and how much pressure will they need?**

For LoadLifter 5000, the recommended minimum air pressure is 5 PSI, but it can safely be run at zero air pressure.

**Q. Is it necessary to add a compressor system to the air springs?**

No. Air pressure can be adjusted with any type of compressor as long as it can produce sufficient pressure to service the springs. Even a bicycle tire pump can be used, but it's a lot of work.

**Q. How long should air springs last?**

If the air springs are properly installed and maintained they can last indefinitely.

**Q. Will raising the vehicle on a hoist for service work damage the air springs?**

No. The vehicle can be lifted on a hoist for short-term service work such as tire rotation or oil changes. However, if the vehicle will be on the hoist for a prolonged period of time, support the axle with jack stands in order to take the tension off of the air springs.



# Limited Warranty and Return Policy

## WHAT THIS WARRANTY COVERS

Air Lift Company provides a warranty to the original purchaser of its Load Support Products, for the periods of time listed below, by product line, from the date of original purchase, that the products will be free from defects in workmanship and materials when used on cars and trucks as specified by Air Lift Company and under normal operating conditions, subject to the requirements and exclusions set forth below.

## WHAT THIS WARRANTY DOES NOT COVER

The warranty does not apply to products that have been improperly applied, improperly installed, or which have not been maintained in accordance with installation instructions furnished with all products. This warranty does not apply and is void if damage or failure is caused by: accident, abuse, misuse (including but not limited to racing or off-road activities or commercial use), abnormal use, faulty installation, liquid contact, fire, earthquake or other external cause; operating the product outside Air Lift Company's instructions, specifications or guidelines; or service, alteration, maintenance or repairs performed by anyone other than Air Lift Company to the product from its purchased condition. This warranty also does not apply to: consumable parts, such as batteries; cosmetic damage, including but not limited to scratches or dents; defects caused by normal wear and tear or otherwise due to the normal aging of the product, or if any serial or identification number has been removed or defaced from the product. Air Lift Company reserves the right to change the design of any product without assuming any obligation to modify any product previously manufactured.

## LIMITATION OF LIABILITY

To the extent permitted by law, this warranty and the remedies set forth herein are exclusive and in lieu of all other warranties, remedies and conditions, whether oral, written, statutory, express or implied. AIR LIFT COMPANY DISCLAIMS ALL STATUTORY AND IMPLIED WARRANTIES, INCLUDING WITHOUT LIMITATION, WARRANTIES OF MERCHANTABILITY AND FITNESS FOR A PARTICULAR PURPOSE AND WARRANTIES AGAINST HIDDEN OR LATENT DEFECTS TO THE EXTENT PERMITTED BY LAW. To the extent such warranties cannot be disclaimed, such implied warranties shall apply only for the warranty period specified above. Please note that some states do not allow limitation on how long an implied warranty (or condition) lasts. So the above limitation may not apply to you.

Except as provided in this warranty and to the extent permitted by law, Air Lift Company shall not be liable for any direct, special, incidental or consequential damages resulting from any breach of warranty or condition, or arising in connection with the sale, use or repair of air lift products, or under any other legal theory, including but not limited to loss of use, loss of revenue, loss of actual or anticipated profits, loss of the use of money, loss of business, loss of opportunity, loss of goodwill, and loss of reputation. Air Lift Company's maximum liability shall not in any case exceed the purchase price paid by you for the Air Lift product. Please note that some states do not allow the exclusion or limitation of incidental or consequential damages, so the above limitation or exclusion may not apply to you.

## HOW TO GET SERVICE

If a defect in workmanship or materials causes your Air Lift product to become inoperable within the warranty period, before returning any defective product, call Air Lift Company at (800) 248-0892 in the U.S. and Canada (elsewhere, (517) 322-2144) to obtain a Returned Materials Authorization (RMA) number. The consumer shall be responsible for removing (labor charges) the defective product from the vehicle and returning it, shipping costs prepaid, to Air Lift Company for verification. Returns to Air Lift Company must be postage prepaid and sent to: Air Lift Company • 2727 Snow Road • Lansing, MI • 48917. You must prove to the satisfaction of Air Lift Company the date of original purchase of your Air Lift product. You must also enclose the RMA number and a return address. A minimum \$10 shipping and handling charge will apply to all warranty claims. You must also pack the product to minimize the risk of it being damaged in transit. If we receive a product in damaged condition as the result of shipping, we will notify you and you must seek a claim with the shipper.

## WHAT AIR LIFT COMPANY WILL DO

If you submit a valid claim to Air Lift Company during the warranty period, Air Lift Company will, at its option, repair your Air Lift product or furnish you with a new or rebuilt product. Air Lift Company will not reimburse you for repairs or replacement parts provided by other parties. Your repaired or replacement Air Lift product will be returned to you (subject to payment of the required warranty claim shipping and handling charge) and it will be covered under the warranty for the balance of the warranty period, if any. When a product or part is replaced, any replacement item becomes your property and the replaced item becomes property of Air Lift Company. You are responsible for installation/reinstallation (labor charges) of the product.

## HOW THE LAW RELATES TO THIS WARRANTY

This warranty gives you specific legal rights and you may also have other rights which vary from state to state. By this warranty, Air Lift Company does not limit or exclude your rights except as allowed by law. To fully understand your rights, you should consult the laws of your state.

## SPECIFIC LOAD SUPPORT WARRANTY PERIODS BY PRODUCT LINE

LoadLifter 5000™ Ultimate .....	Lifetime Limited	WirelessAIR™ .....	2 Year Limited
LoadLifter 5000™ .....	Lifetime Limited	WirelessONE™ .....	2 Year Limited
RideControl™ .....	Lifetime Limited	LoadController™ Single and Dual.....	2 Year Limited
Air Lift 1000™ .....	Lifetime Limited	LoadController™ I and II .....	2 Year Limited
AirCell™ .....	Lifetime Limited	SmartAir™ II .....	2 Year Limited
SlamAir™ .....	Lifetime Limited	Other Accessories.....	2 Year Limited



# Replacement Part Information

If replacement parts are needed, contact the local dealer or call Air Lift customer service at **(800) 248-0892**. Most parts are immediately available and can be shipped the same day.

**Contact Air Lift Company customer service at (800) 248-0892 first if:**

- Parts are missing from the kit.
- Need technical assistance on installation or operation.
- Broken or defective parts in the kit.
- Wrong parts in the kit.
- Have a warranty claim or question.

**Contact the retailer where the kit was purchased:**

- If it is necessary to return or exchange the kit for any reason.
- If there is a problem with shipping if shipped from the retailer.
- If there is a problem with the price.

# Contact Information

<b>Mailing address</b>	P.O. Box 80167 Lansing, MI 48908-0167
<b>Shipping address for returns</b>	2727 Snow Road Lansing, MI 48917
<b>Phone</b>	Toll free: (800) 248-0892 International: (517) 322-2144
<b>Email</b>	service@airliftcompany.com
<b>Web address</b>	www.airliftcompany.com

## Need Help?

Contact Air Lift Company customer service department by calling (800) 248-0892.

For calls from outside the USA or Canada, dial (517) 322-2144.



*Thank you for purchasing Air Lift products — the professional installer's choice!*

Air Lift Company • 2727 Snow Road • Lansing, MI 48917 or P.O. Box 80167 • Lansing, MI 48908-0167  
Toll Free (800) 248-0892 • Local (517) 322-2144 • Fax (517) 322-0240 • [www.airliftcompany.com](http://www.airliftcompany.com)

Printed in the USA  
BGL-0816