

Installation Instructions

I - Sheet Number BF98 Rev.B



Bugflector® - Bugflector II® - Carflector® - Chrome Hood Shield™

For proper installation and best possible fit, please read all instructions **BEFORE** you begin.
For technical assistance or to obtain missing parts, please call Customer Relations at 1-800-241-7219.

Important Safety Information



- CAUTION - Before driving, ensure that the hood shield is properly secured to vehicle.
- Do not use automatic "brush-style" car washes.
- Do not use cleaning solvents of any kind.
- Periodically check all components for tightness.

Contents

NOTE: Actual product may vary from illustration.



Hood shield



Bump Ons x4



Hood Insert x4
(39-4150)



Washer x4
(98022)



Fasteners x2
(98059)

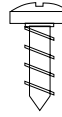

Screws x4
(98023)

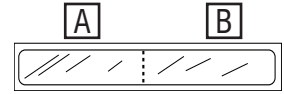

Protective Film (Long)



Protective Film (Short)

Tools Required



Car Wash Supplies

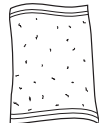

Clean Towel

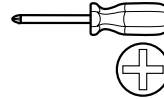

Phillips Screwdriver

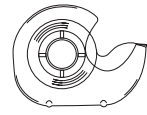

Tape

Preparation Before Painting / Installation

- A trial fit is recommended to ensure proper positioning and fit.
- Check fit of parts before painting as we will not accept the return of modified or painted parts.
- Wash and dry your vehicle to remove any debris and/or dirt from the installation area.

Installation Steps

NOTE: Actual application may vary slightly from illustrations.

Open hood.

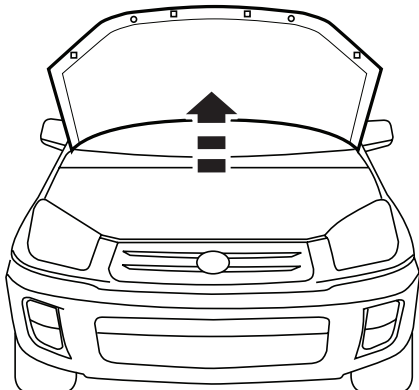

1

Locate (4) square holes and (2) round holes on underside of hood.

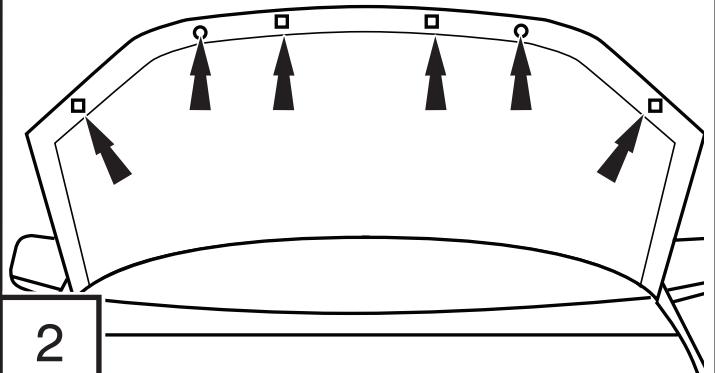

2

Installation Steps

NOTE: Actual application may vary slightly from illustrations.

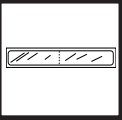

Center one (1) long strip of protective film along the leading edge of the hood. **Wrap** the protective film along the hood edge. **DO NOT COVER HOLES.**

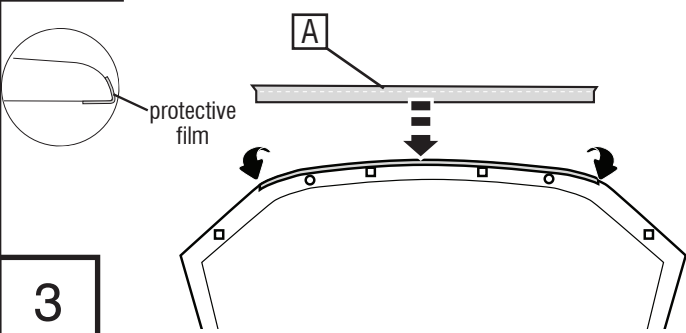

3

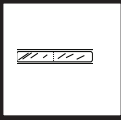

Wrap two (2) short pieces of protective film around the leading edge of the hood closest to the headlights

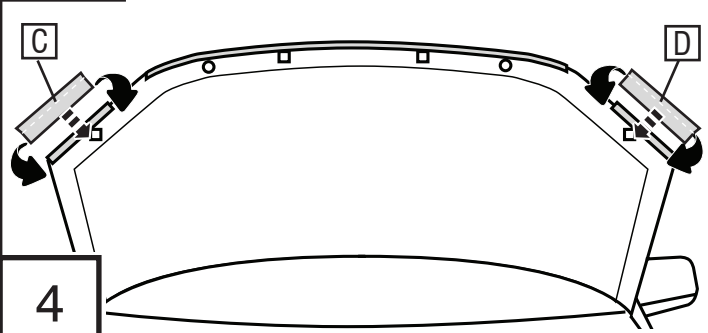

4

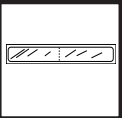

Center one (1) long strip of protective film along the leading edge of the outer grille housing. Place the protective film along the **TOP** of the housing.

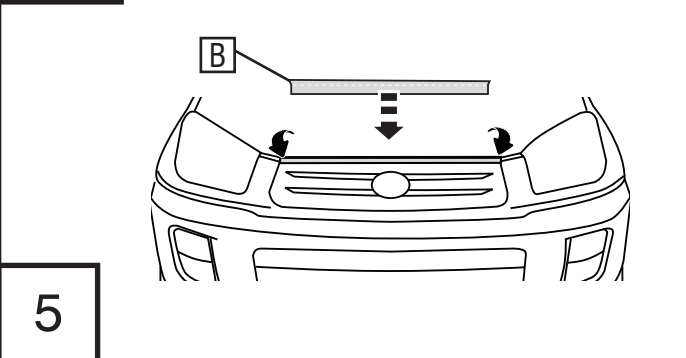

5

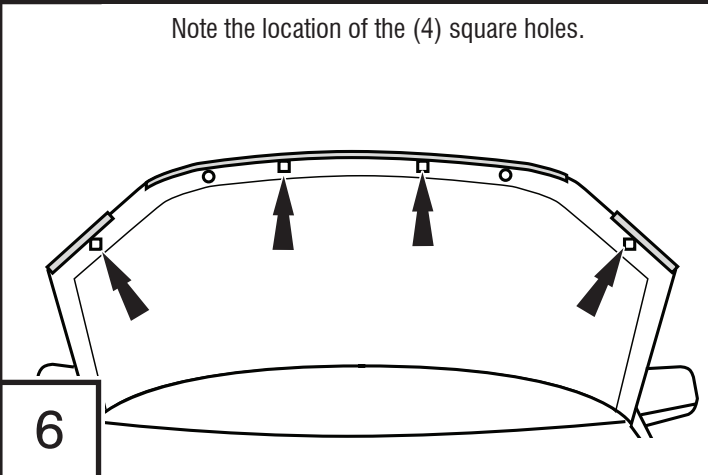

6

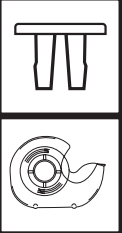

Press (4) hood inserts into the (4) square holes. If necessary use tape to hold them firmly in place.

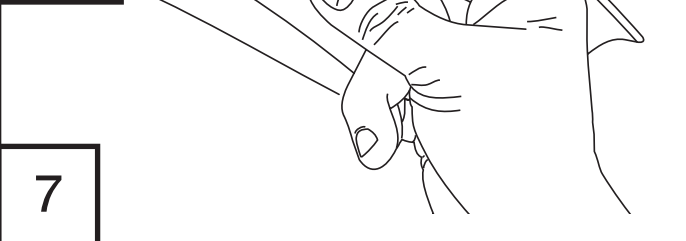

7

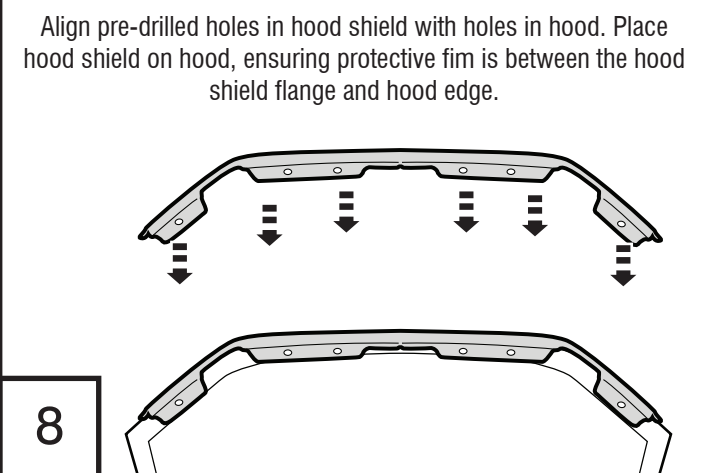

8

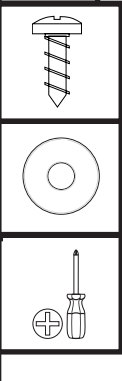

Using a Phillips screwdriver install (4) screws with (4) washers at the locations noted in **Step 6**.



9

square hole
hood
hood insert
hood shield
washer
screw

DO NOT OVER TIGHTEN

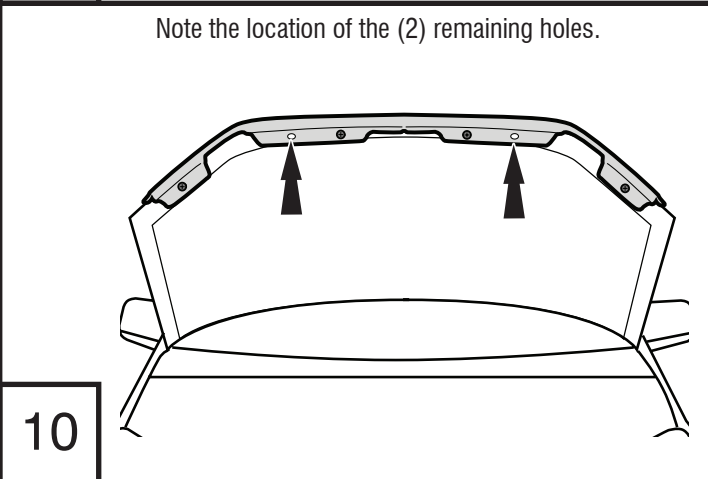

10

Note the location of the (2) remaining holes.

Installation Steps **NOTE:** Actual application may vary slightly from illustrations.



Insert (1) fastener and push firmly through hole in hood shield and into hood to secure. Repeat for remaining hole location.

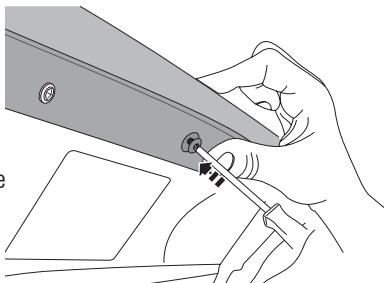
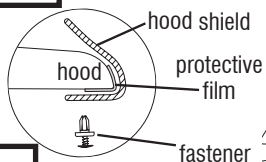

DO NOT OVER TIGHTEN



Close hood, and install bump ons at pre-cleaned locations on the painted hood surface.

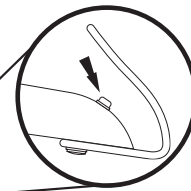
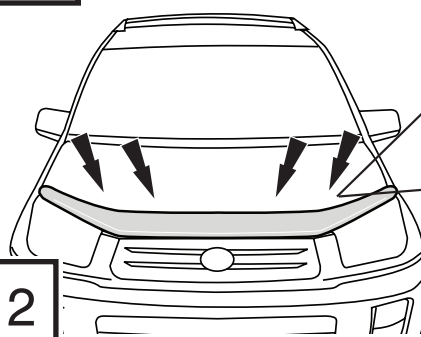

11

12

Care and Cleaning

- Wash only with mild soap & dry with a clean cloth.

Congratulations!

You have purchased one of the many quality Auto Ventshade™ branded products offered by Lund International, Inc. We take the utmost pride in our products and want you to enjoy years of satisfaction from your investment. We have made every effort to ensure that your product is top quality in terms of fit, durability, finish and ease of installation.



Lund International

800-241-7219 • Visit us at lundinternational.com

© 2012 Lund International, Inc. All rights reserved.

Auto Ventshade™, the Auto Ventshade™ logo and the AVS™ logo are trademarks of Lund International, Inc.





Bugflector® - Bugflector II® - Carflector® - Chrome Hood Shield™

Pour obtenir une installation correcte et le meilleur ajustement possible, lire toutes les instructions AVANT de commencer. Pour toute assistance technique ou obtention de pièces manquantes, appeler le service des relations avec la clientèle au 1-800-241-7219.

Informations importantes concernant la sécurité



- ATTENTION – Avant de conduire, s'assurer que le pare-insectes est solidement assujettie sur le véhicule.
- Ne pas utiliser les stations de lavage de voitures à brosse.
- Ne pas utiliser de solvants.
- Vérifier régulièrement le serrage des composants.

Contenu **NOTE:** Le produit réel peut changer de l'illustration.



Protection de capot



4 gommes



2 fixations (98059)

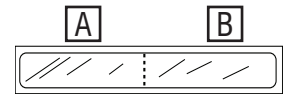

Film protecteur (long)



4 espaceurs de capot (39-4150)



4 rondelles (98022)

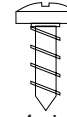

4 vis (98023)

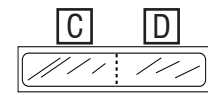

Film protecteur (court)

Outils nécessaires



Fournitures pour lavage de voiture



Serviette propre

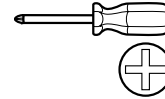

Tournevis Phillips

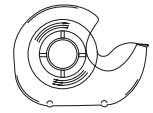

Bande adhésive

Préparation pour la peinture/l'installation

- Il est recommandé de procéder à un essai pour s'assurer que le positionnement et l'ajustement sont corrects.
- Vérifier l'ajustement des pièces avant peinture, car nous n'acceptons pas le retour de pièces modifiées ou peintes.
- Laver les glissières de glaces de la portière du véhicule pour éliminer toute poussière et tous débris.
- Sécher les glissières avec une serviette propre.

Étapes d'installation

REMARQUE : La méthode d'application peut être légèrement différente de celle représentée par les illustrations.

Ouvrez le capot.

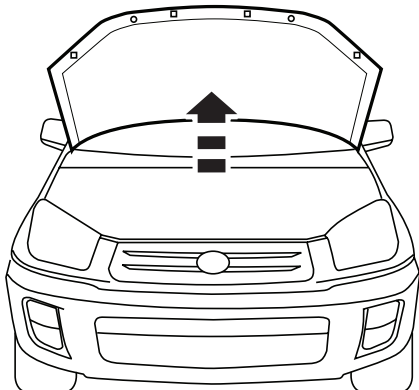

1

Repérez 4 orifices carrés et 2 orifices ronds sur la face inférieure du capot.

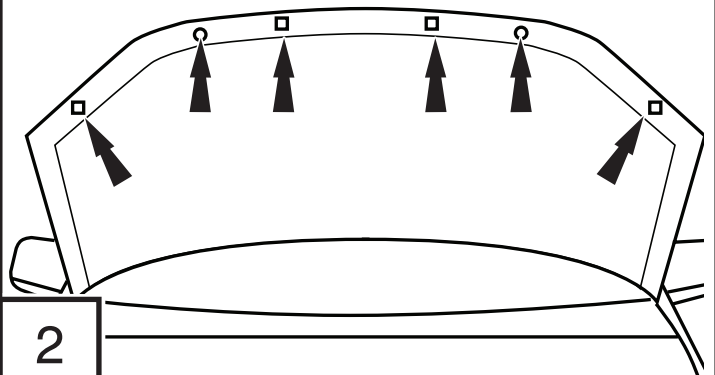

2

Étapes d'installation

REMARQUE : La méthode d'application peut être légèrement différente de celle représentée par les illustrations.

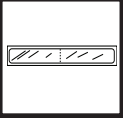

Centrez une longue bande de film protecteur le long du bord avant du capot. **Enveloppez** le bord du capot à l'aide du film protecteur. **NE PAS COUVRIR LES ORIFICES.**

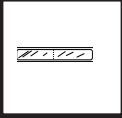
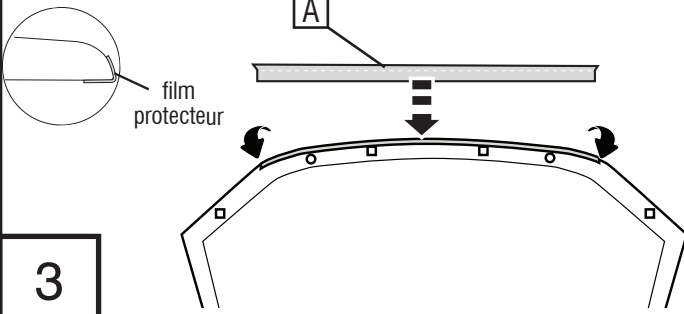

Enveloppez le bord du capot à proximité des phares à l'aide de 2 courts morceaux de film protecteur

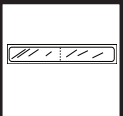
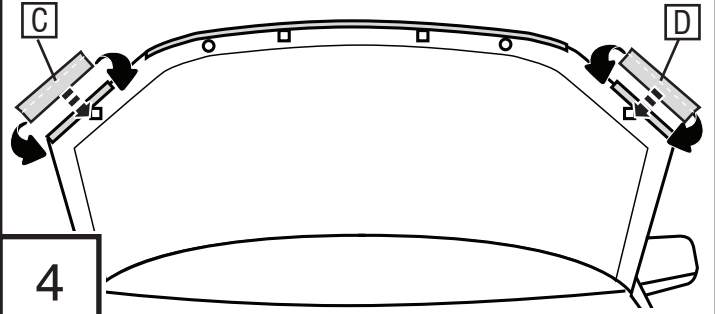

Centrez une longue bande de film protecteur le long du bord avant du capot au niveau du logement de la calandre externe. Apposez le film protecteur sur le bord **SUPÉRIEUR** du logement.

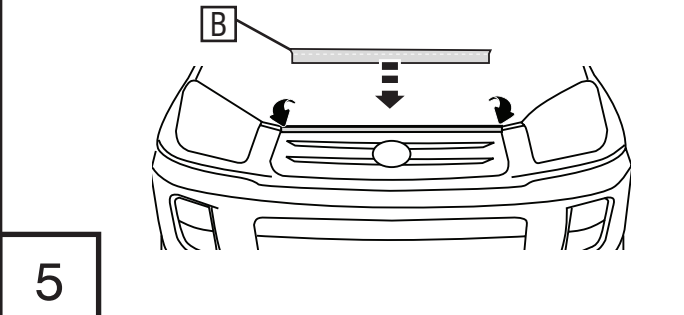

Marquez l'emplacement des 4 orifices carrés.

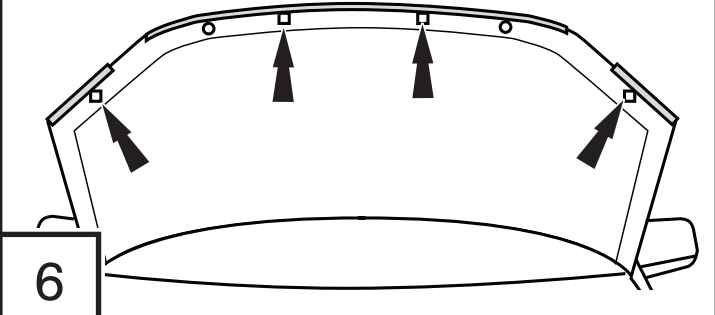

Enfoncez les 4 espaceurs de capot dans les 4 orifices carrés. Au besoin, utilisez la bande adhésive pour les maintenir en place.

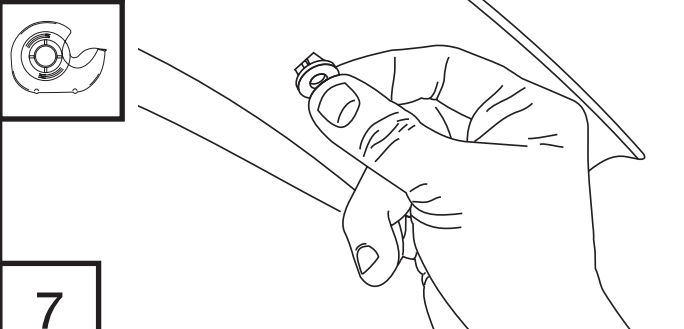

Alignez les orifices pré taraudés dans la protection du capot sur les orifices du capot. Placez la protection du capot sur le capot en vous assurant que le film protecteur se trouve entre la bride de la protection du capot et le bord du capot.

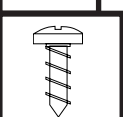
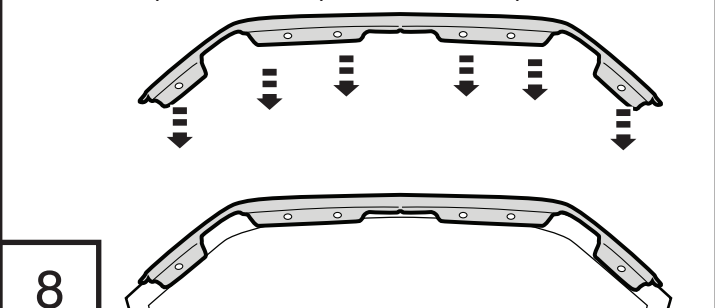

À l'aide d'un tournevis, posez les 4 vis avec les 4 rondelles aux emplacements marqués à l'Étape 6.

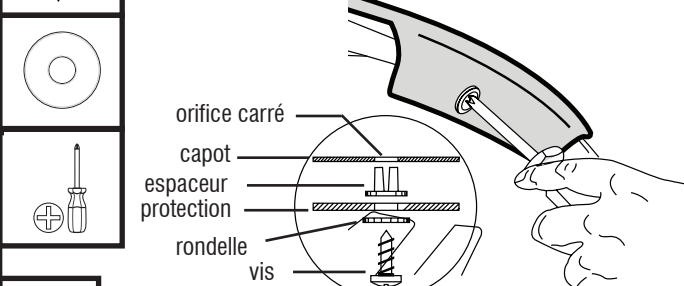

NE PAS SERRER À L'EXCÈS

Marquez l'emplacement des 2 autres orifices.

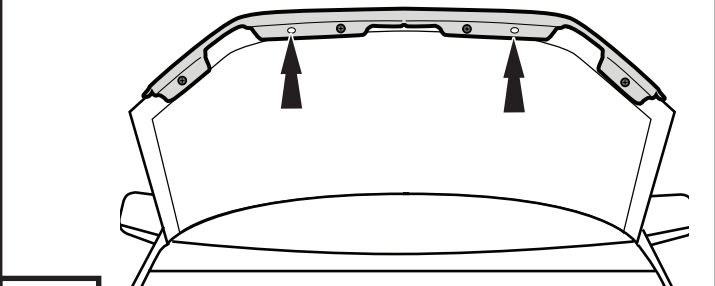

Étapes d'installation

REMARQUE : La méthode d'application peut être légèrement différente de celle représentée par les illustrations.



Insérez 1 fixation, enfoncez-la dans l'orifice de la protection du capot jusqu'à ce qu'elle s'emboîte dans le capot. Procédez de même pour l'autre emplacement.



Fermez le capot et posez les gomes aux emplacements pré-nettoyés sur la surface peinte du capot.

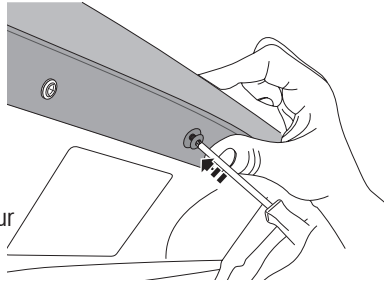
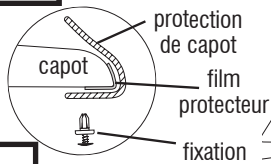

11

NE PAS SERRER À L'EXCÈS

12

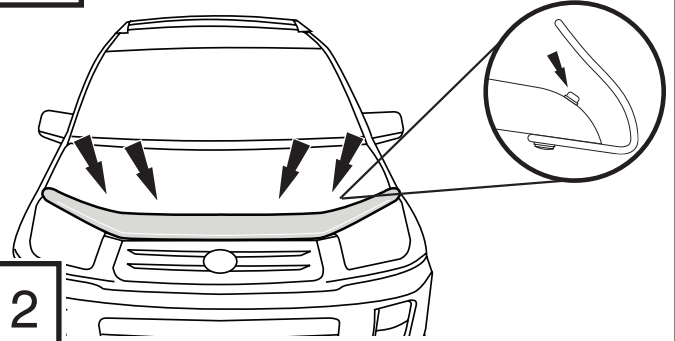

Entretien et nettoyage

- Laver exclusivement avec de l'eau savonneuse et sécher avec un chiffon propre.

Félicitations !

Vous avez acheté l'un des nombreux produits de qualité Auto Ventshade™ fabriqués par Lund International, Inc. Nous sommes extrêmement fiers de nos produits et souhaitons que vous tiriez des années de satisfaction de votre investissement. Nous avons pris toutes les mesures nécessaires pour assurer que ce produit est d'une qualité supérieure en ce qui concerne l'ajustement, la durabilité, la finition et la facilité d'installation.



Lund International

800-241-7219 • Visitez notre site lundinternational.com

© 2012 Lund International, Inc. Tous droits réservés.



Auto Ventshade™, le logo Auto Ventshade™ et le logo AVS™ sont des marques déposées de Lund International, Inc.





Bugflector® - Bugflector II® - Carflector® - Chrome Hood Shield™

Para una instalación adecuada y el mejor ajuste posible, lea todas las instrucciones ANTES de comenzar. Si desea recibir asistencia técnica u obtener piezas faltantes, llame al Servicio al cliente al 1-800-241-7219.

Información importante de seguridad



- PRECAUCIÓN - Antes de conducir, asegúrese de que la visera deflectora esté correctamente anclada al vehículo.
- No utilice servicios automáticos de limpieza de vehículos que utilizan cepillos.
- No utilice limpiadores al solvente de ningún tipo.
- Compruebe periódicamente que todos los componentes estén ajustados.

Contenido

NOTA: El producto real puede variar de la ilustración.



Cubierta del capó



Topes de goma x4

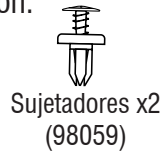

Sujetadores x2
(98059)

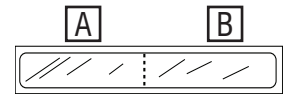

Película protectora (larga)



Inserto del capó x4
(39-4150)



Arandelas x4
(98022)

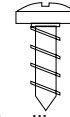

Tornillos x4
(98023)



Película protectora (corta)

Herramientas necesarias



Equipo de limpieza de vehículos

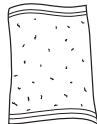

Toalla limpia

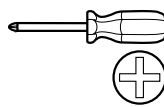

Destornillador Phillips

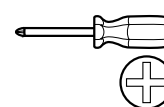

Destornillador Phillips

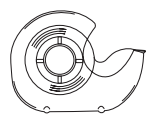

Cinta

Preparación antes de pintar o instalar

- Se recomienda realizar un ajuste de prueba para asegurar el posicionamiento y ajuste correctos.
- Compruebe que las piezas se ajusten correctamente antes de pintarlas, ya que no aceptaremos la devolución de piezas modificadas o pintadas.
- Lave los canales de la ventanilla del vehículo para quitar los desechos y la suciedad.
- Seque los canales de la ventanilla con una toalla limpia.

Pasos de instalación

NOTA: El uso real puede variar levemente de ilustraciones.

Abra el capó.

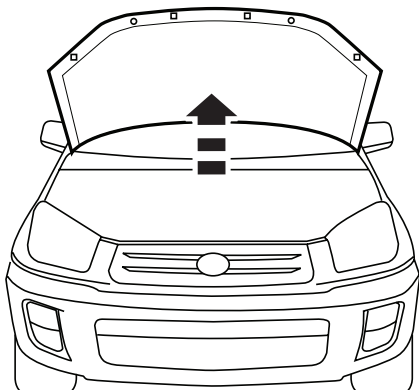

1

Encuentre los cuatro (4) orificios cuadrados y los dos (2) orificios redondos en la parte inferior del capó.

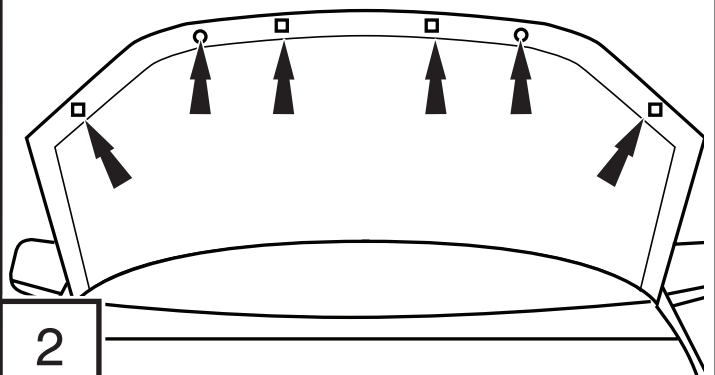

2

Pasos de instalación

NOTA: El uso real puede variar levemente de ilustraciones.

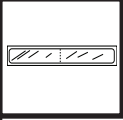

Centre una (1) tira larga de película protectora a lo largo del borde anterior del capó. **Envuelva** con la película protectora el borde del capó. **NO CUBRA LOS ORIFICIOS.**

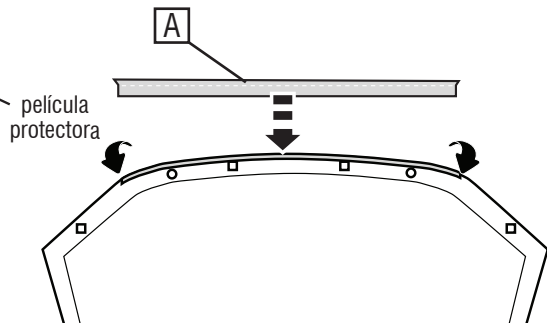
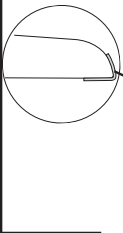

3

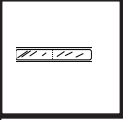

Envuelva con dos (2) pedazos cortos de película protectora el borde anterior del capó más cercano a los faros delanteros.



4

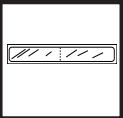

Centre una (1) tira larga de película protectora a lo largo del borde anterior del alojamiento de la parrilla externa. Coloque la película protectora a lo largo de la parte **SUPERIOR** del alojamiento.



5

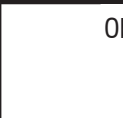

Observe el lugar de los cuatro (4) orificios cuadrados.

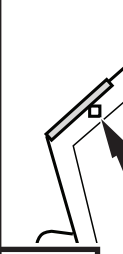

6



Presione los cuatro (4) insertos de capó en los cuatro (4) orificios cuadrados. Si es necesario, coloque cinta para sujetarlos con firmeza en su lugar.

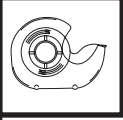

7

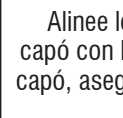

Alinee los orificios previamente perforados en la cubierta del capó con los orificios del capó. Coloque la cubierta del capó en el capó, asegúrese de que la película protectora se encuentre entre el reborde de la cubierta del capó y su borde.



8

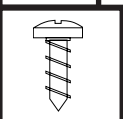

Use un destornillador Phillips y coloque los (4) tornillos con las (4) arandelas en los lugares observados en el Paso 6.

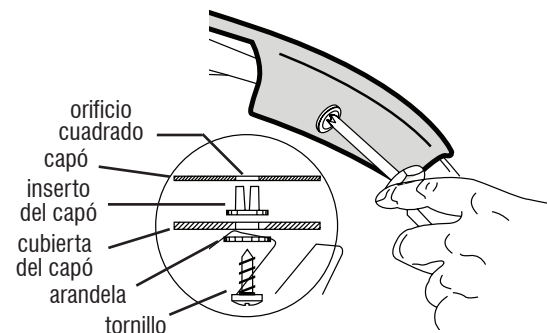
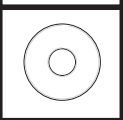

9

NO AJUSTE DEMASIADO



Observe el lugar de los dos (2) orificios restantes.



10

Pasos de instalación

NOTA: El uso real puede variar levemente de ilustraciones.



Introduzca un (1) sujetador y empuje con firmeza a través del orificio del capó y hacia adentro de este para ajustar. Repita este paso en los lugares de los orificios restantes.



Cierre el capó e instale los topes de goma en las partes limpias sobre la superficie pintada del capó.

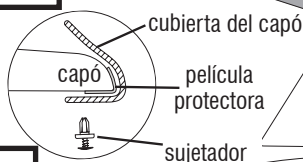

cubierta del capó

capó

película protectora

sujetador

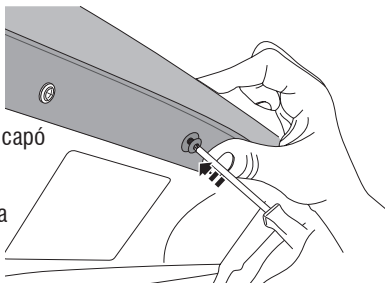

NO AJUSTE DEMASIADO

11

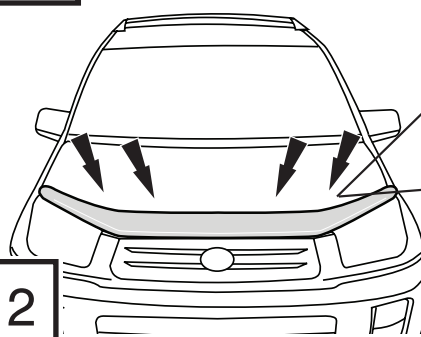

12

Cuidado y limpieza

- Limpie solamente con agua jabonosa tibia y seque con un paño limpio.

Felicidades

Usted ha comprado uno de los tantos artículos de calidad de Auto Ventshade™ ofrecidos por Lund International, Inc. Nuestros productos son nuestro mayor orgullo. Deseamos que disfrute de años de satisfacción con su inversión. Hemos realizado todos los esfuerzos para asegurarnos de que su producto sea de la mejor calidad en cuanto a ajuste, durabilidad, acabado y facilidad de instalación.



Lund International

800-241-7219 • Visite nuestro sitio Web: lundinternational.com

© 2012 Lund International, Inc. Todos los derechos reservados.



Auto Ventshade™, el logo de Auto Ventshade™ y el logo de AVS™ son marcas comerciales de Lund International, Inc.

