



Ventvisor® Deflector

**For proper installation and best possible fit, please read all instructions BEFORE you begin.
For technical assistance or to obtain missing parts, please call Customer Relations at 1-800-241-7219.**

Important Safety Information



- CAUTION - Before driving, insure that the vent visor is properly secured to vehicle.
- Do not use automatic "brush-style" car washes.
- Do not use cleaning solvents of any kind.
- Periodically check all components to make sure they are secure.

Contents - 2 Piece Set

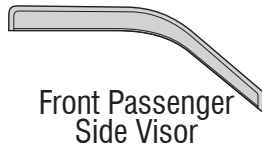

Contents - 4 Piece Set

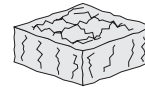
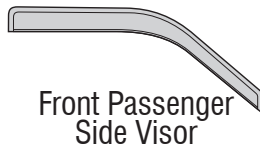

Tools Required



Preparation Before Painting / Installation

- A trial fit is recommended to ensure proper positioning and fit.
- Check fit of parts before painting as we will not accept the return of modified or painted parts.
- Wash your vehicle to remove any debris and/or dirt from installation area.
- Dry the installation area with a clean towel.

Installation Steps

NOTE: Actual application may vary slightly from illustrations.



Scuff rubber trim with Scotch Brite scuff pad. Clean trim/mirror cap with alcohol pad.



rubber window trim

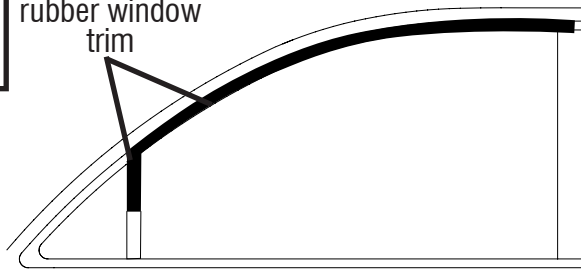

1

Peel back tape liner 2" on front and rear end flanges.

rear end flange

lateral flange

front end flange

2

Align driver side vent visor with previously cleaned area and apply pressure to exposed tape

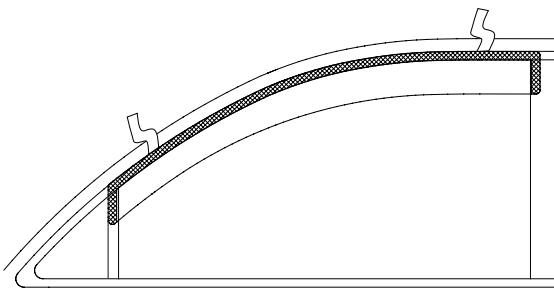

3

Remove remaining tape liner.

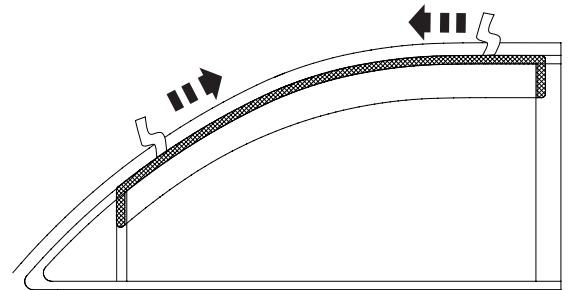

4

Apply pressure along length of vent visor to secure.

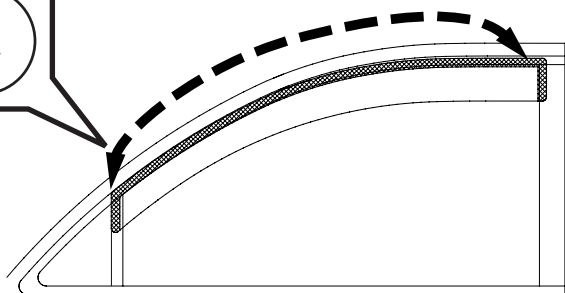

5

Repeat installation procedure for passenger side front vent visor.

Installation Steps

NOTE: Actual application may vary slightly from illustrations.

4 piece Set



Alcohol Pad

Scuff rubber trim with Scotch Brite scuff pad. Clean trim along top of door with alcohol pad.

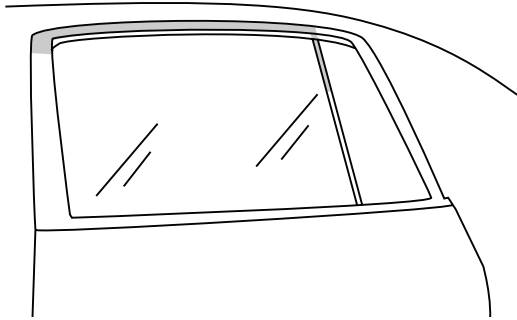

6

Remove tape liner from front and rear flanges. Peel back 2" of tape liner from each end.



7

Align vent visor with previously cleaned area and apply pressure to exposed tape. Remove remaining tape liner.

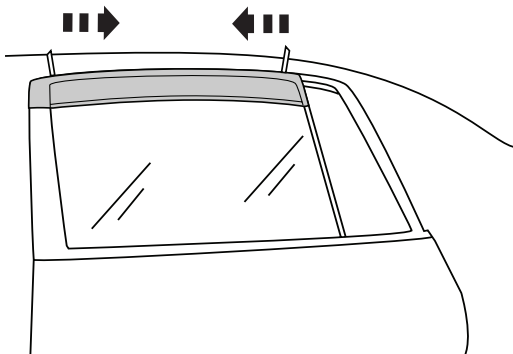

8

Apply pressure along length of vent visor to secure.

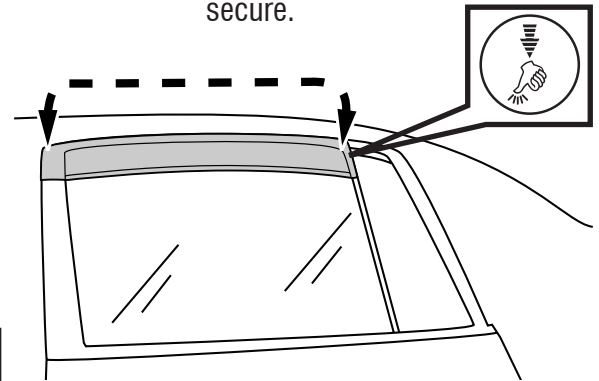

9

Repeat installation procedure for passenger side rear vent visor.

Care and Cleaning

- Wash only with mild soap & dry with a clean cloth.

Congratulations!

You have purchased one of the many quality Auto Ventshade™ branded products offered by Lund International, Inc. We take the utmost pride in our products and want you to enjoy years of satisfaction from your investment. We have made every effort to ensure that your product is top quality in terms of fit, durability, finish and ease of installation.



Lund International

800-241-7219 • Visit us at lundinternational.com

© 2016 Lund International, Inc. All rights reserved.

Auto Ventshade™, the Auto Ventshade™ logo and the AVS™ logo are trademarks of Lund International, Inc.





Ventvisor® Deflector

Pour obtenir une installation correcte et le meilleur ajustement possible, lire toutes les instructions AVANT de commencer.
Pour toute assistance technique ou obtention de pièces manquantes, appeler le service des relations avec la clientèle au 1-800-241-7219.

Informations importantes concernant la sécurité



- ATTENTION – Avant de conduire, s'assurer que la visière est solidement assujettie sur le véhicule.
- Ne pas utiliser les stations de lavage de voitures à brosses.
- Ne pas utiliser de solvants.
- Vérifier régulièrement le serrage des composants.

Contenu - Ensemble 2 pièces

NOTE: Le produit réel peut changer de l'illustration.



Tampons à
l'alcool (2)

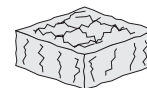

Tampon
Scotch Brite

Contenu - Ensemble 4 pièces



Visière arrière
côté conducteur



Visière arrière
côté passager



Tampons à l'alcool (4)

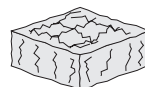

Tampon Scotch Brite

Outils nécessaires



Fournitures pour
lavage de voiture



Serviette propre

Préparation pour la peinture/l'installation

- Il est recommandé de procéder à un essai pour s'assurer que le positionnement et l'ajustement sont corrects.
- Vérifier l'ajustement des pièces avant peinture, car nous n'acceptons pas le retour de pièces modifiées ou peintes.
- Laver les glissières de glaces de la portière du véhicule pour éliminer toute poussière et tous débris.
- Sécher les glissières avec une serviette propre.

Étapes d'installation

REMARQUE : La méthode d'application peut être légèrement différente de celle représentée par les illustrations.

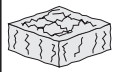

Frotter la garniture en caoutchouc avec le tampon à récurer Scotch Brite. Nettoyer la garniture et le couvercle du rétroviseur avec un tampon à l'alcool.

Alcohol Pad

équilibre en caoutchouc de fenêtre

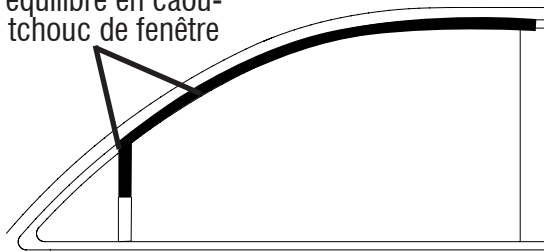

1

Décoller 5 cm (2 po) de protection d'adhésif des rebords des extrémités avant et arrière.

Rebord d'extrémité arrière

Rebord latéral

Rebord d'extrémité avant

2

Aligner la visière du côté conducteur et la zone préalablement nettoyée, puis appuyer sur le ruban adhésif exposé.

Le placer sur le couvercle du rétroviseur

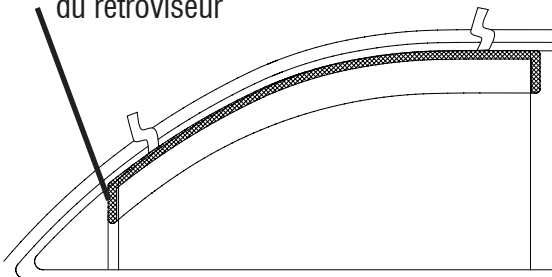

3

Retirer le restant de la protection d'adhésif.

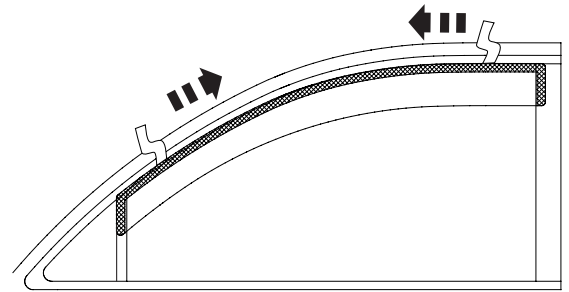

4

Appuyer tout le long de la visière pour bien l'assujettir.

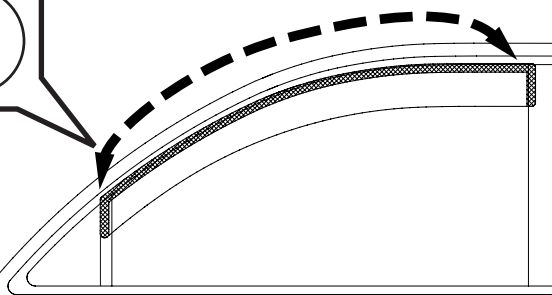

5

Répéter la procédure d'installation pour la visière avant du côté passager.

Étapes d'installation Ensemble 4 pièces

REMARQUE : La méthode d'application peut être légèrement différente de celle représentée par les illustrations.



Frotter la garniture en caoutchouc avec le tampon à récurer Scotch Brite. Avec un tampon à l'alcool, nettoyer la garniture le long du haut de la portière.

Alcohol Pad

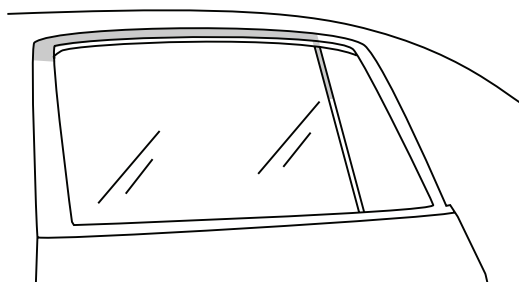

6

Retirer la protection d'adhésif des rebords avant et arrière. Décoller environ 5 cm (2 po) de protection d'adhésif à chaque extrémité.

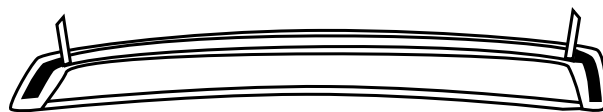

7

Aligner la visière et la zone préalablement nettoyée, puis appuyer sur le ruban adhésif exposé. Retirer le reste de la protection d'adhésif.

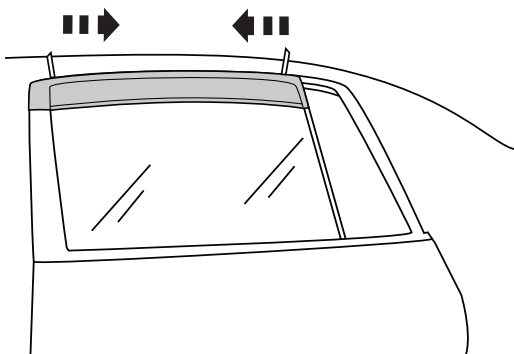

8

Appuyer tout le long de la visière pour bien l'assujettir.

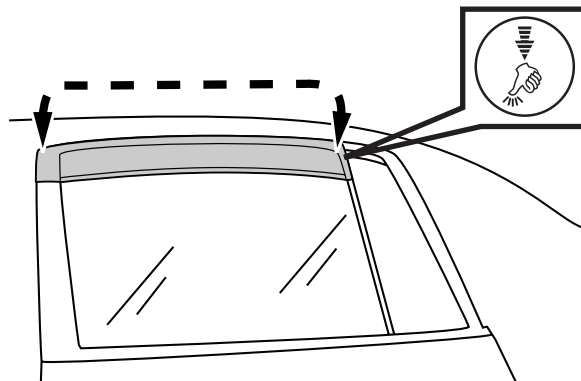

9

Répéter la procédure d'installation pour la visière arrière du côté passager.

Entretien et nettoyage

- Laver exclusivement avec de l'eau savonneuse et sécher avec un chiffon propre.

Félicitations !

Vous avez acheté l'un des nombreux produits de qualité Auto Ventshade™ fabriqués par Lund International, Inc. Nous sommes extrêmement fiers de nos produits et souhaitons que vous tiriez des années de satisfaction de votre investissement. Nous avons pris toutes les mesures nécessaires pour assurer que ce produit est d'une qualité supérieure en ce qui concerne l'ajustement, la durabilité, la finition et la facilité d'installation.



Lund International

800-241-7219 • Visitez notre site lundinternational.com

© 2016 Lund International, Inc. Tous droits réservés.



Auto Ventshade™, le logo Auto Ventshade™ et le logo AVS™ sont des marques déposées de Lund International, Inc.





Ventvisor® Deflector

Para una instalación adecuada y el mejor ajuste posible, lea todas las instrucciones ANTES de comenzar. Si desea recibir asistencia técnica u obtener piezas faltantes, llame al Servicio al cliente al 1-800-241-7219.

Información importante de seguridad



- PRECAUCIÓN - Antes de conducir, asegúrese de que la visera deflectora esté correctamente anclada al vehículo.
- No utilice servicios automáticos de limpieza de vehículos que utilizan cepillos.
- No utilice limpiadores al solvente de ningún tipo.
- Compruebe periódicamente que todos los componentes estén ajustados.

Contenido - Juego de dos piezas **NOTA:** El producto real puede variar de la ilustración.



Paños esterilizados x 2

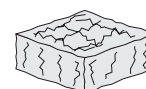

Paño Scotch Brite

Contenido - Juego de cuatro piezas



Paños esterilizados x 4



Paño Scotch Brite

Herramientas necesarias



Equipo de limpieza de vehículos



Toalla limpia

Preparación antes de pintar o instalar

- Se recomienda realizar un ajuste de prueba para asegurar el posicionamiento y ajuste correctos.
- Compruebe que las piezas se ajusten correctamente antes de pintarlas, ya que no aceptaremos la devolución de piezas modificadas o pintadas.
- Lave los canales de la ventanilla del vehículo para quitar los desechos y la suciedad.
- Seque los canales de la ventanilla con una toalla limpia.

Pasos de instalación

AVISO: La colocación real puede variar con respecto a las ilustraciones.



Pula la banda lateral de goma con paño para restregar Scotch Brite. Limpie la banda lateral y la cubierta del espejo con un paño esterilizado.

Alcohol Pad

ajuste de goma de la ventana

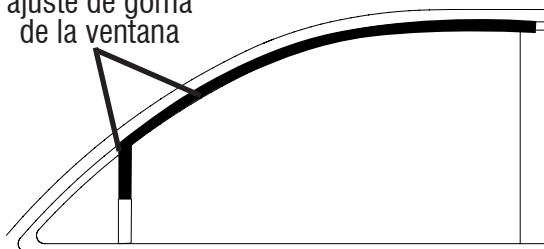

1

Retire 2 pulgs. de cinta protectora de los rebordes frontal y trasero.

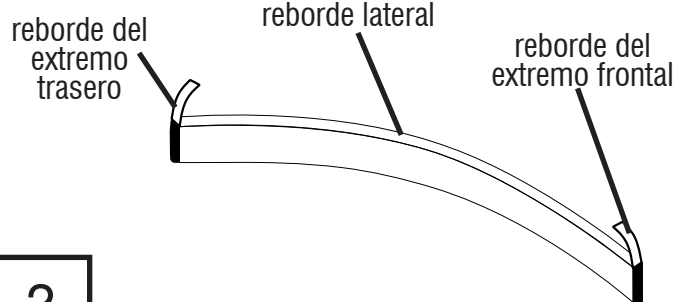

2

Alinee la visera del conductor con la superficie que limpió anteriormente y presione la cinta que quedó expuesta.

Coloque sobre la cubierta del espejo

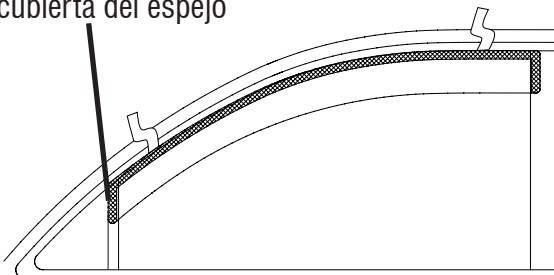

3

Quite la cinta protectora restante.

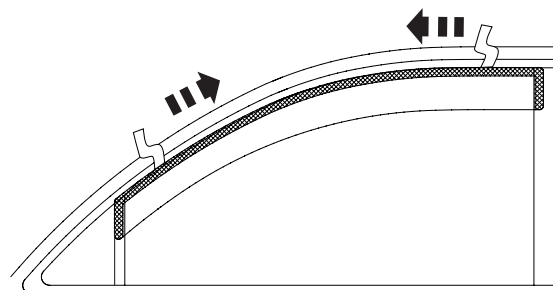

4

Presione sobre toda la superficie de la visera para fijarla.

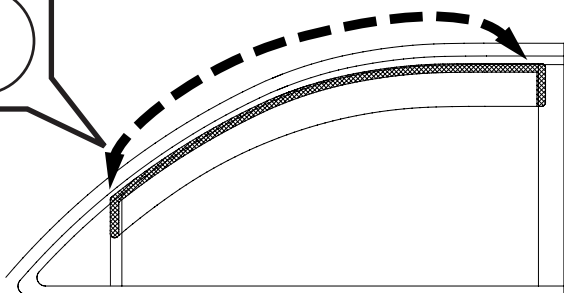

5

Repita el procedimiento de instalación para la visera delantera del acompañante.

Pasos de instalación

AVISO: La colocación real puede variar con respecto a las ilustraciones.

Juego de cuatro piezas



Pula la banda lateral de goma con paño para restregar Scotch Brite. Limpie la banda lateral a lo largo de la parte superior de la puerta con un paño esterilizado.

Alcohol Pad

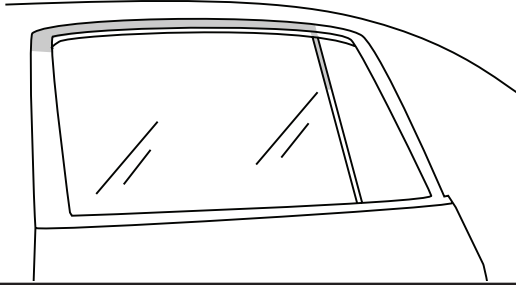

6

Retire la cinta protectora de los rebordes frontales y traseros. Retire 2 pulgs. de cinta protectora de cada uno de los extremos.

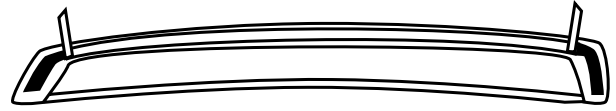

7

Alinee la visera con la superficie que limpió anteriormente y presione la cinta que quedó expuesta. Quite la cinta protectora restante.

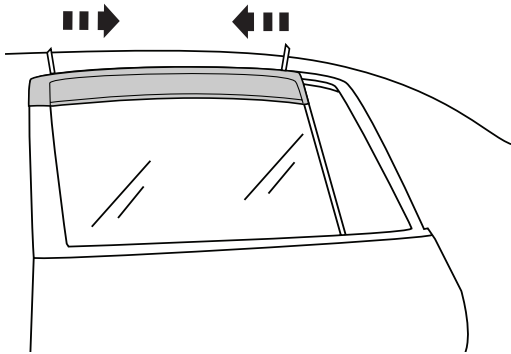

8

Presione sobre toda la superficie de la visera para fijarla.

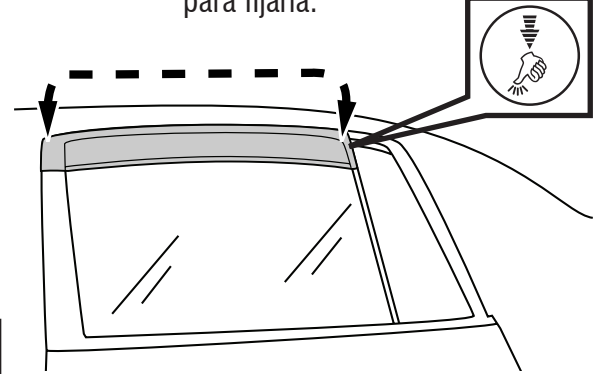

9

Repita el procedimiento de instalación para la visera trasera del lado del acompañante.

Cuidado y limpieza

- Limpie solamente con agua jabonosa tibia y seque con un paño limpio.

Felicidades

Usted ha comprado uno de los tantos artículos de calidad de Auto Ventshade™ ofrecidos por Lund International, Inc. Nuestros productos son nuestro mayor orgullo. Deseamos que disfrute de años de satisfacción con su inversión. Hemos realizado todos los esfuerzos para asegurarnos de que su producto sea de la mejor calidad en cuanto a ajuste, durabilidad, acabado y facilidad de instalación.



Lund International

800-241-7219 • Visite nuestro sitio Web: lundinternational.com

© 2016 Lund International, Inc. Todos los derechos reservados.



Auto Ventshade™, el logo de Auto Ventshade™ y el logo de AVS™ son marcas comerciales de Lund International, Inc.

