











Installation Instructions Mirror Mounting Brackets

Vehicle Application:

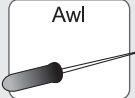
- Jeep \ CJ-7 with 2-Piece Bestop Doors and 51261 Mirrors
1976 – 2006
Part Number: 51258

www.Bestop.com - We're here to help! Visit our web site and click on "[Ask a Question](#)". Click here for more [Jeep® Accessories by Bestop](#).

INSTALLATION TIME	SKILL LEVEL		
 1 Hour	    1 - Easy		
TOOLS			
 Awl	 Utility Knife	 Phillips Screwdriver #2	 Safety Glasses



⚠ WARNING This product is designed primarily to enhance the appearance of the vehicle. Do not rely in any way on the components of this product to protect against injury or death in the event of an accident. Never operate the vehicle in excess of manufacturer's specifications.

WEAR SEAT BELTS AT ALL TIMES

Read and follow, precisely, all installation instructions provided when installing product. Failure to do so may result in a poor fit and could place occupants of the vehicle in a potentially dangerous situation.

Mirror Mounting Bracket Installation Instructions

Parts List and Hardware Identification

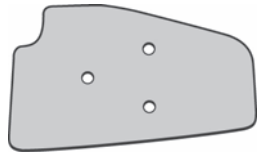

□ Outer Mounting Plate, Part Number 443.75, Qty - 2

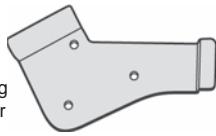

□ Left Inner Mounting Plate, Part Number 443.77, Qty - 1

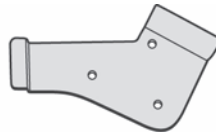

□ Right Inner Mounting Plate, Part Number 443.76, Qty - 1

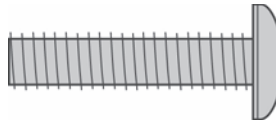

□ 1/4-20 x 1-1/4 Phillips Pan Head Screw, Part Number 397.22, Qty - 6

2 Punch Holes

Push the bracket up as high as it will go. Locate the tapped holes in the bracket with an awl and poke a hole in the fabric at each hole location. Cut away the fabric around each hole.

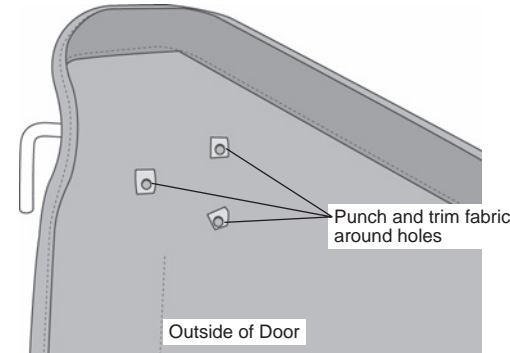

1 Install Inner Mounting Plate

Slide the Left Inner Mounting Plate under the fabric flap on the inside of the left door. Hook the rear of the bracket over the diagonal rod of the door frame. Push the front of the bracket into the hole in the fabric next to the top pivot pin so it overlaps the frame.

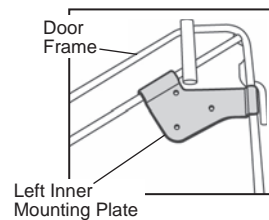
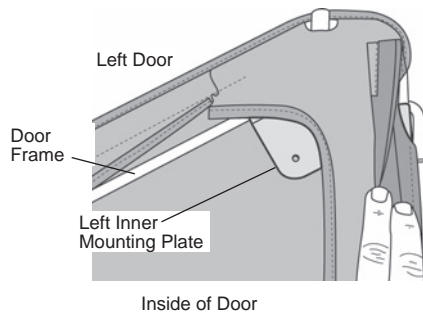

3 Install Outer Mounting Plate and Mirror

Lay an Outer Mounting Plate on the outside of the door and align the holes with the holes in the Inner Mounting Plate. Hold the left mirror over the outer plate and mount it to the inner plate with three (3) 1/4-20 x 1-1/4" Phillips Pan Head Screws. Alternate tightening each screw until the mirror is secure.

Repeat Steps 1 - 3 on the right door.

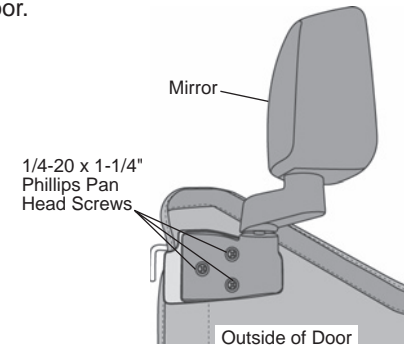
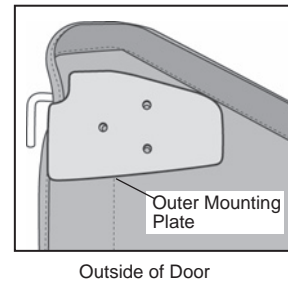

Mirror Mounting Bracket Installation Instructions

For Bestop Warranty Information, Please go to;
<https://www.bestop.com/help/warranty-information/>

