





Installation Instructions Upper Door Replacement Kit for Factory Original Soft Top and Bestop Replace-a-Top

Vehicle Application

- Jeep Wrangler with Steel Half Door
1986 - 1995
Part Number: 51782

This door may be installed on 1986-1987 vehicles. The door retainer in Step Two must first be purchased from your dealer.

www.Bestop.com - We're here to help! Visit our web site and click on ["Ask a Question"](#). Click here for more [Jeep Accessories by Bestop](#).

INSTALLATION TIME	SKILL LEVEL
 Less Than 1/4 Hour	 1 - Easy

TOOLS
 Safety Glasses





Installation Tips

Before you begin installing this assembly, read all instructions thoroughly.

For a smooth fit:

For ease in installation, the product should be installed at temperatures above 72° F. Below this temperature, the fabric may contract an inch or more, making it difficult to fit to the vehicle. It is normal for fabric to contract and wrinkle when stored in the shipping carton. Within a few days after the installation, the fabric will relax and the wrinkles will disappear.

 **CAUTION** Safety glasses should be worn at all times while installing this product.

 **WARNING** This product is designed primarily to enhance the appearance of the vehicle and to shield the occupants from ordinary weather conditions. Do not rely in any way on the components of this product to contain occupants within the vehicle, or to protect against injury or death in the event of an accident. This product will not protect the occupants from falling objects. Never operate the vehicle in excess of manufacturer's specifications.

WEAR SEAT BELTS AT ALL TIMES

Read and follow, precisely, all installation instructions provided when installing product. Failure to do so may result in a poor fit and could place occupants of the vehicle in a potentially dangerous situation.

Upper Door Replacement Kit – Installation Instructions

Parts List

Door, Upper - Right	Qty - 1
Door, Upper - Left	Qty - 1



WARNING

The doors in this product are designed only for protection against the elements. Do not rely on the doors to contain occupants within the vehicle or to protect against injury during an accident. Door handles are only designed to aid in door closure. Door handle **will not** support a person's weight.

1

Install Upper Door into Lower Door

Starting with the front pin, slip the pins into the sockets in the lower door. Make sure that the pins are well seated in the sockets. Close the door to check that it fits properly against the body.

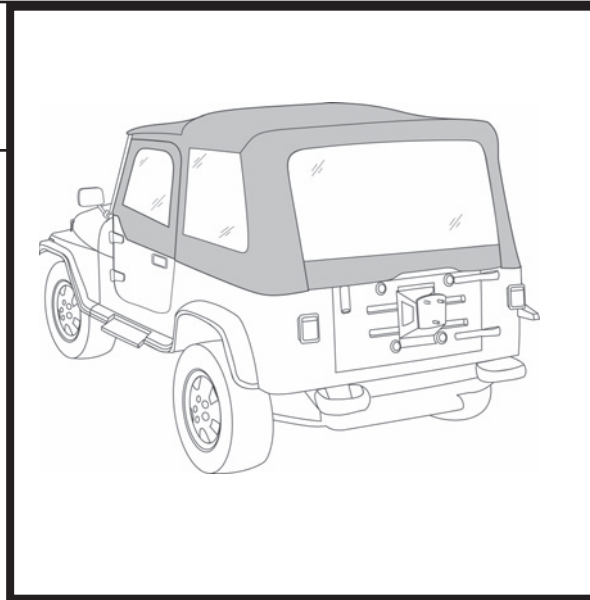
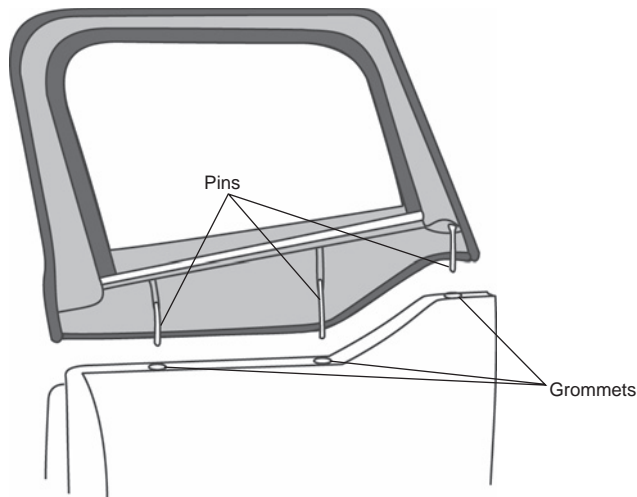

2

Secure Fabric to Door

Fasten the snap at front of upper door. Slip plastic strip on the bottom of the soft door into the retainer on the steel door.



Important: This door may be installed on 1986-1987 vehicles, however, the door retainer in Step Two must first be purchased from your dealer.

Snap Fabric to Door

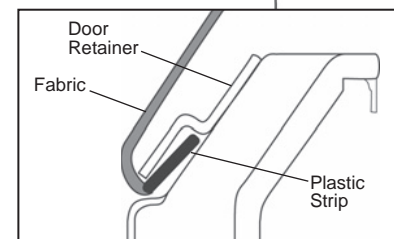



Care and Maintenance of your Bestop Product

Your Bestop product is made of the finest materials available. To keep it looking new and for the maximum possible wear, it will need periodic cleaning and maintenance.

Fabric: The fabric should be washed often using soap, warm water and a soft bristle brush. Rinse with clear water to remove all traces of soap. Bestop recommends using Bestop Cleaner (part no. 11201-00) and Bestop Protectant (part no. 11202-00) for Vinyl fabric and Bestop Twill Protectant (part no. 11207-00) for Twill fabric. Bestop Cleaner and Bestop protectant are specially formulated to provide a total cleaning and protection system. Bestop Cleaner safely removes the toughest stains, will not harm vehicle finishes, is biodegradable and environmentally friendly. Bestop Protectant protects against UV-fading, cracking and hardening, and repels dust, grease, dirt and mildew.

Windows: Keep windows clean to avoid scratching. DO NOT use a brush on the windows! Wash with a water-soaked cloth or sponge and a mild dishwashing detergent. Bestop recommends Bestop Vinyl Window Cleaner (part no. 11203-00), which safely cleans and protects vinyl windows and helps prevent UV damage. NEVER WIPE THE WINDOWS WHEN THEY ARE DRY. Be careful when cleaning snow or frost from the vinyl windows since they are easily scratched and may crack at low temperatures. DO NOT roll the sides or rear window in cold weather. The windows become stiff and will crack. Cracks caused by misuse in cold temperatures are not covered under warranty.

Water: Seeping through at the seams may be stopped by applying 3-M Scotchgard® on the inside of the seams.

Snaps: Keep snaps cleaned and lubricated with silicone to help prevent snaps from sticking to the studs. If a snap does become stuck to a stud, use a screwdriver and GENTLY pry apart to prevent permanent damage to the snap or the top fabric.

Zippers: Keeping zippers cleaned and lubricated with Bestop's Zipper Cleaner (part no. 11206-00) will help prevent damage and keep the zippers in smooth working condition. If a zipper opens behind the slider, the slider may have been spread apart. This problem can usually be repaired by using an ordinary pair of pliers to bring the sides back into parallel. Return slider to the end of the zipper in the normal Open position. Squeeze lightly at first and test the zipper. If the zipper continues to remain open squeeze more firmly with the pliers and try the zipper again. Repeat this procedure until the zipper operates correctly.

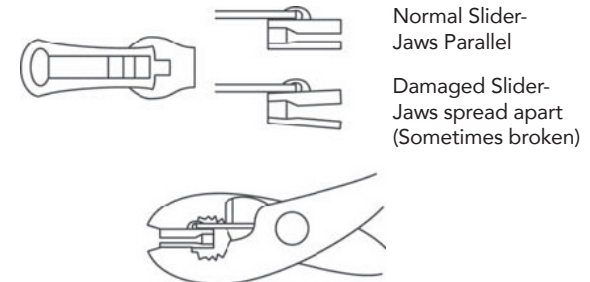

For Bestop Warranty Information, Please go to;
<https://www.bestop.com/help/warranty-information/>

