



Installation Instructions Tailgate Bar and Retainers

Vehicle Application:
Jeep® Wrangler and Unlimited JL 2018-Current
Part Number 52700-01

Installation Tips

Before you begin installing your new Tailgate Bar and Retainers, please read all the instructions thoroughly.





WARNING Do not rely in any way on the components of this product to protect against injury or death in the event of an accident. Never operate the vehicle in excess of manufacturer's specifications.

Read and follow, precisely, all installation instructions provided when installing this product. Failure to do so may result in a poor fit and could place occupants of the vehicle in a potentially dangerous situation.



WEAR SEAT BELTS AT ALL TIMES

CAUTION Safety glasses should be worn at all times when installing this product.

Tools	Installation Time	Support
<div style="display: flex; justify-content: space-around; align-items: center;"> <div style="text-align: center;">  <p>Safety Glasses</p> </div> <div style="text-align: center;">  <p>T50 Torx Driver</p> </div> </div>	<div style="text-align: center;">  <p>30 minutes</p> </div> <hr/> <div style="text-align: center;"> <p>Skill Level</p> <div style="display: flex; justify-content: center; gap: 10px;"> <div style="border: 1px solid black; border-radius: 50%; width: 30px; height: 30px; display: flex; align-items: center; justify-content: center;">1</div> <div style="border: 1px solid black; border-radius: 50%; width: 30px; height: 30px; display: flex; align-items: center; justify-content: center;">2</div> <div style="border: 1px solid black; border-radius: 50%; width: 30px; height: 30px; display: flex; align-items: center; justify-content: center;">3</div> <div style="border: 1px solid black; border-radius: 50%; width: 30px; height: 30px; display: flex; align-items: center; justify-content: center;">4</div> </div> <p>1 - Easy</p> </div>	<p>We're here to help! Go to: https://www.bestop.com and click on Need Help?</p> <div style="text-align: center;">  </div> <p>https://www.bestop.com/video-library</p>



Installation Instructions Tailgate Bar and Retainers

Vehicle Application:
Jeep® Wrangler and Unlimited JL 2018-Current
Part Number 52700-01

Sugerencias de Instalación

Antes de empezar a instalar esta unidad, lea atentamente todas las instrucciones.

Para un buen ajuste:

Para facilitar la instalación, el producto debe instalarse a temperaturas superiores a 72 °F (22 °C).

Por debajo de esta temperatura, la tela puede encogerse una pulgada o más, lo que dificultaría su ajuste al vehículo.

Es normal que la tela se contraiga o arrugue cuando está guardada en la caja de empaque. A los pocos días después de la instalación, la tela se relajará y las arrugas desaparecerán.



ADVERTENCIA

Este producto se diseñó principalmente para mejorar la apariencia del vehículo y proteger a los ocupantes de las condiciones climáticas comunes. De ninguna manera piense que los componentes de este producto pueden servir como medio de contención para los ocupantes del vehículo o que pueden protegerlos contra lesiones o la muerte en caso de accidente. Este producto no protegerá a los ocupantes contra caídas de objetos. Nunca conduzca este vehículo fuera de las especificaciones del fabricante.

USE LOS CINTURONES DE SEGURIDAD EN TODO MOMENTO

Lea y siga con precisión todas las instrucciones de instalación que se proporcionan para instalar este producto. Si no lo hace, podría producirse un mal ajuste que colocaría a los ocupantes del vehículo en una situación potencialmente peligrosa.



PRECAUCIÓN

Debe usar gafas protectoras en todo momento durante la instalación de este producto.

Conseils pour l'installation

Lire toutes les instructions au complet avant de commencer l'installation de cet assemblage.

Pour un ajustement sans problème :

Afin de faciliter l'installation, ce produit doit être installé à des températures au-dessus de 72 °F (22 °C).

Sous cette température, le tissu peut rétrécir d'un pouce (2,5 cm) ou plus, ce qui rendra l'ajustement sur le véhicule difficile.

Il est normal que le tissu rétrécisse et plisse pendant qu'il est dans la boîte d'expédition. En quelques jours après l'installation, le tissu se détendra et les plis disparaîtront.



AVERTISSEMENT

Ce produit est conçu principalement pour améliorer l'apparence du véhicule et pour protéger les occupants des conditions météorologiques usuelles. Ne jamais se fier aux composants de ce produit pour se protéger de blessures ou de la mort en cas d'accident. Ce produit ne protégera pas les occupants des chutes d'objets. Ne jamais utiliser le véhicule au-delà des caractéristiques techniques indiquées par le fabricant.

PORTER UNE CEINTURE DE SÉCURITÉ EN TOUT TEMPS

Lire et suivre, très fidèlement, toutes les instructions d'installation fournies lors de l'installation de ce produit. Ne pas suivre cette consigne peut causer une installation inadéquate et mettre les occupants du véhicule dans une situation potentiellement dangereuse.



MISE EN GARDE

Des lunettes de sécurité doivent être portées en tout temps lors de l'installation de ce produit.



Installation Instructions Tailgate Bar and Retainers

Vehicle Application:
Jeep® Wrangler and Unlimited JL 2018-Current
Part Number 52700-01

Parts List

- Required parts for installation - Page number in Installation Guide

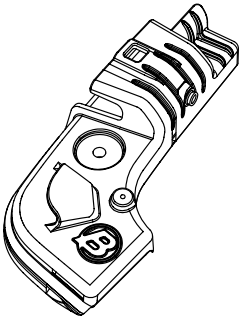
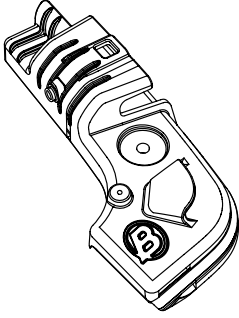
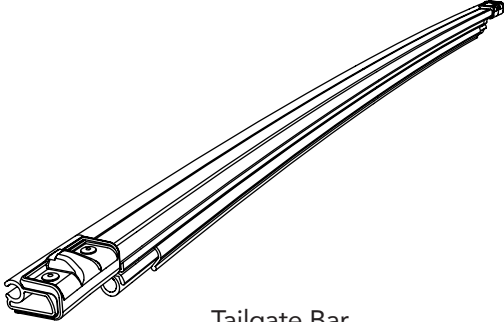
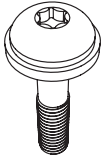
Sections 1 and 2	Tailgate Bar Retainers, Tailgate Bar, Socket Cap Screws		Pages 4 and 5 of Guide
 <p>Tailgate Bar Retainer Part #575.38 - Right Qty. 1</p>	 <p>Tailgate Bar Retainer Part #575.39 - Left Qty. 1</p>	 <p>Tailgate Bar Part #575.33 Qty. 1</p>	 <p>M8x1.25x38 Button Head Socket Cap Screw #532.17 Qty. 2</p>

Step 1 575.38 575.39 532.17

Hardware

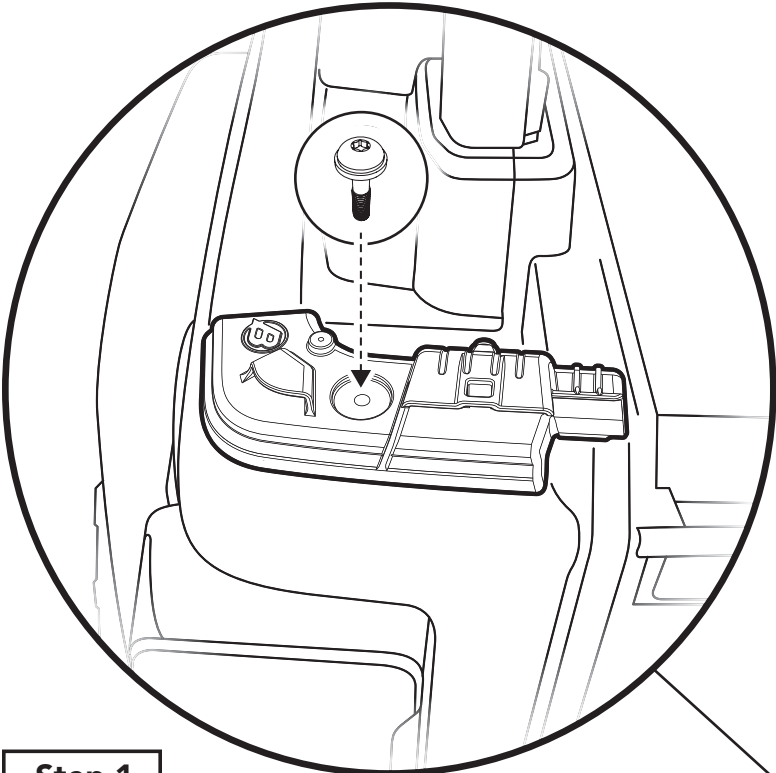

Tailgate Bar Retainer
Part #575.38 - Right
Qty. 1



Tailgate Bar Retainer
Part #573.39 - Left
Qty. 1

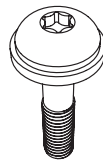

M8x1.25x38
Button Head
Socket Cap Screw
#532.17
Qty. 2

Tools



T50 Torx Driver

Step 1

Attach the Tailgate Bar Retainers #575.38 (right) and #575.39 (left) to the Jeep Belt Rail, using one (1) M8x1.25x38 Button Head Socket Cap Screw #532.17 per retainer.

Insert the screws through the retainers, and into threaded holes in the top of the Jeep belt rail, and tighten.

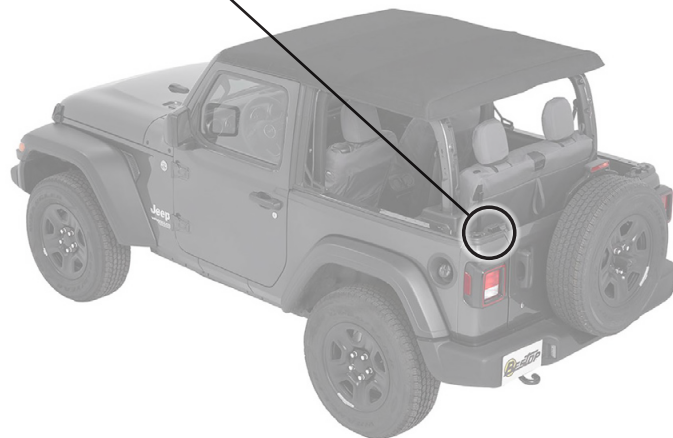

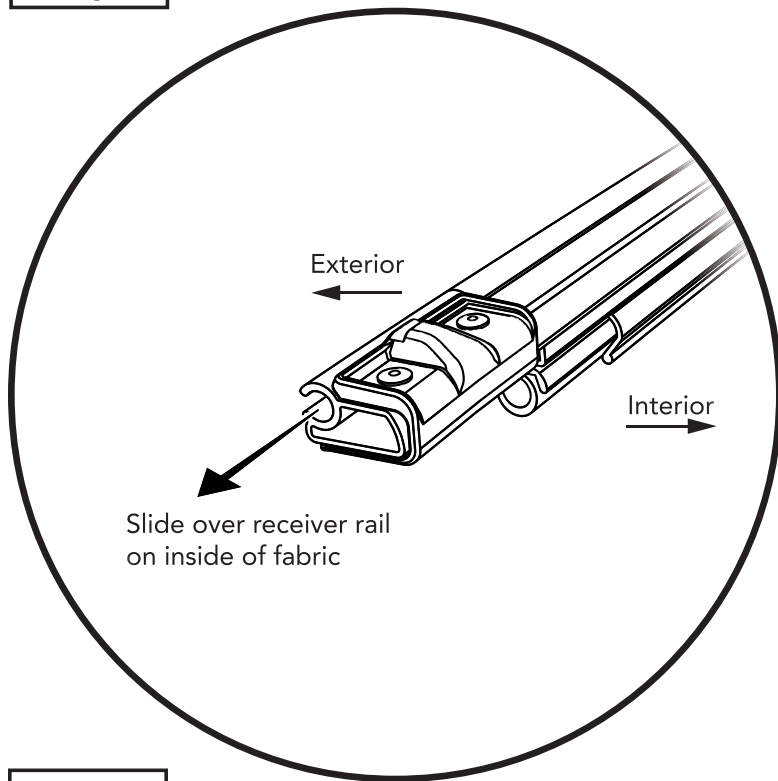
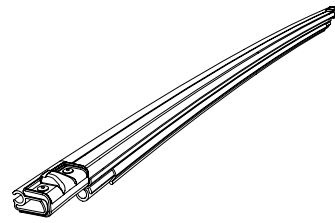
Step 1**Hardware**

Tailgate Bar
Part #575.33
Qty. 1

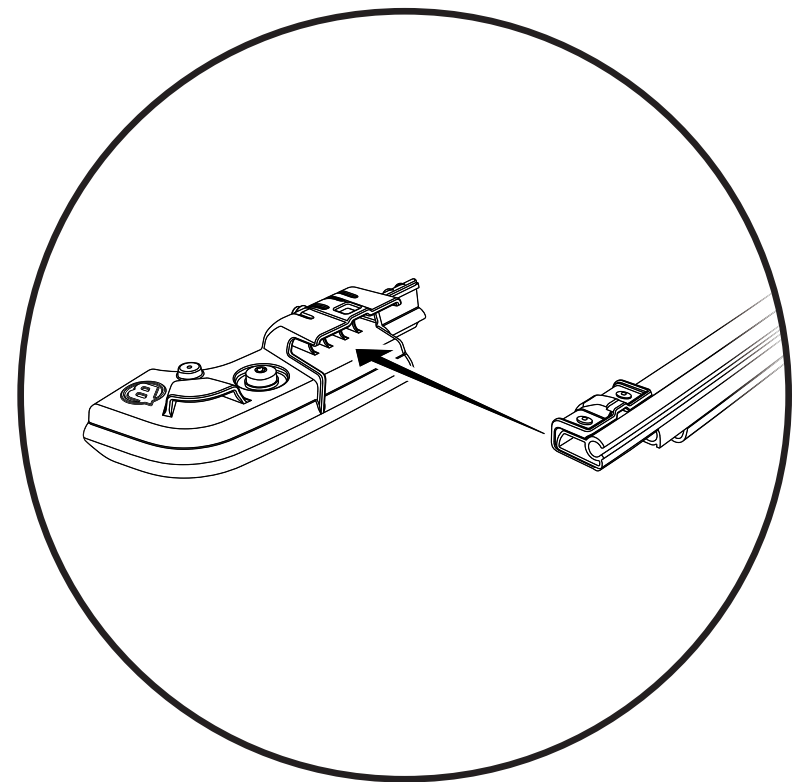
Step 2**Step 1**

Attach the Tailgate Bar #575.33 to the sewn-in receiver rail on the inside of the fabric cover.

Slide the Tailgate Bar over the rail, and all the way across.

Step 2

Secure the Tailgate Bar with attached fabric to the Tailgate Bar Retainers.

Press the Tailgate Bar into the receiver on each Tailgate Bar Retainer.



Care and Maintenance of your Bestop Product

Your Bestop product is made of the finest materials available. To keep it looking new and for the maximum possible wear, it will need periodic cleaning and maintenance.

Fabric: The fabric should be washed often using soap, warm water and a soft bristle brush. Rinse with clear water to remove all traces of soap. Bestop recommends using Bestop Cleaner (part no. 11201-00) and Bestop Protectant (part no. 11202-00) for Vinyl fabric and Bestop Twill Protectant (part no. 11207-00) for Twill fabric. Bestop Cleaner and Bestop protectant are specially formulated to provide a total cleaning and protection system. Bestop Cleaner safely removes the toughest stains, will not harm vehicle finishes, is biodegradable and environmentally friendly. Bestop Protectant protects against UV-fading, cracking and hardening, and repels dust, grease, dirt and mildew.

Windows: Keep windows clean to avoid scratching. DO NOT use a brush on the windows! Wash with a water-soaked cloth or sponge and a mild dishwashing detergent. Bestop recommends Bestop Vinyl Window Cleaner (part no. 11203-00), which safely cleans and protects vinyl windows and helps prevent UV damage. NEVER WIPE THE WINDOWS WHEN THEY ARE DRY. Be careful when cleaning snow or frost from the vinyl windows since they are easily scratched and may crack at low temperatures. DO NOT roll the sides or rear window in cold weather. The windows become stiff and will crack. Cracks caused by misuse in cold temperatures are not covered under warranty.

Water: Seeping through at the seams may be stopped by applying 3-M Scotchgard® on the inside of the seams.

Snaps: Keep snaps cleaned and lubricated with silicone to help prevent snaps from sticking to the studs. If a snap does become stuck to a stud, use a screwdriver and GENTLY pry apart to prevent permanent damage to the snap or the top fabric.

Zippers: Keeping zippers cleaned and lubricated with Bestop's Zipper Cleaner (part no. 11206-00) will help prevent damage and keep the zippers in smooth working condition. If a zipper opens behind the slider, the slider may have been spread apart. This problem can usually be repaired by using an ordinary pair of pliers to bring the sides back into parallel. Return slider to the end of the zipper in the normal Open position. Squeeze lightly at first and test the zipper. If the zipper continues to remain open squeeze more firmly with the pliers and try the zipper again. Repeat this procedure until the zipper operates correctly.

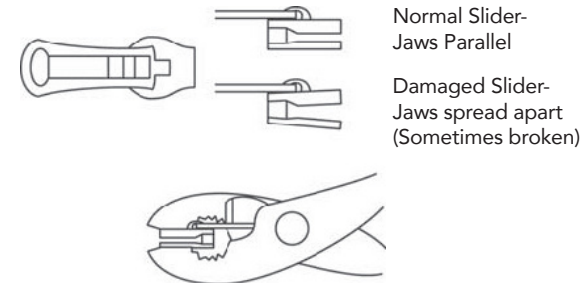

For Bestop Warranty Information, Please go to;
<https://www.bestop.com/help/warranty-information/>

