



Installation Instructions

JL 4 Door Replacement Window (Tint)

Vehicle Application:
JL Wrangler Unlimited 2018-Current
(Left Side)
Part Number 58303

Before you begin installing your new Replacement Window, please read all the instructions thoroughly..

WARNING

Do not rely in any way on the components of this product to protect against injury or death in the event of an accident. Never operate the vehicle in excess of manufacturer's specifications.





Read and follow, precisely, all installation instructions provided when installing this product. Failure to do so may result in a poor fit and could place occupants of the vehicle in a potentially dangerous situation.

"For easier installation, the window should be installed at a temprature above 72° F. Below this temprature, the fabric may contract making it difficult to fit the vehicle."

CAUTION

Safety glasses should be worn at all times when installing this product.

WEAR SEAT BELTS AT ALL TIMES

Tools		Time and Difficulty	
 Safety Glasses	 T15, Torx Driver	 15 Minutes	 2 - Moderatly Easy

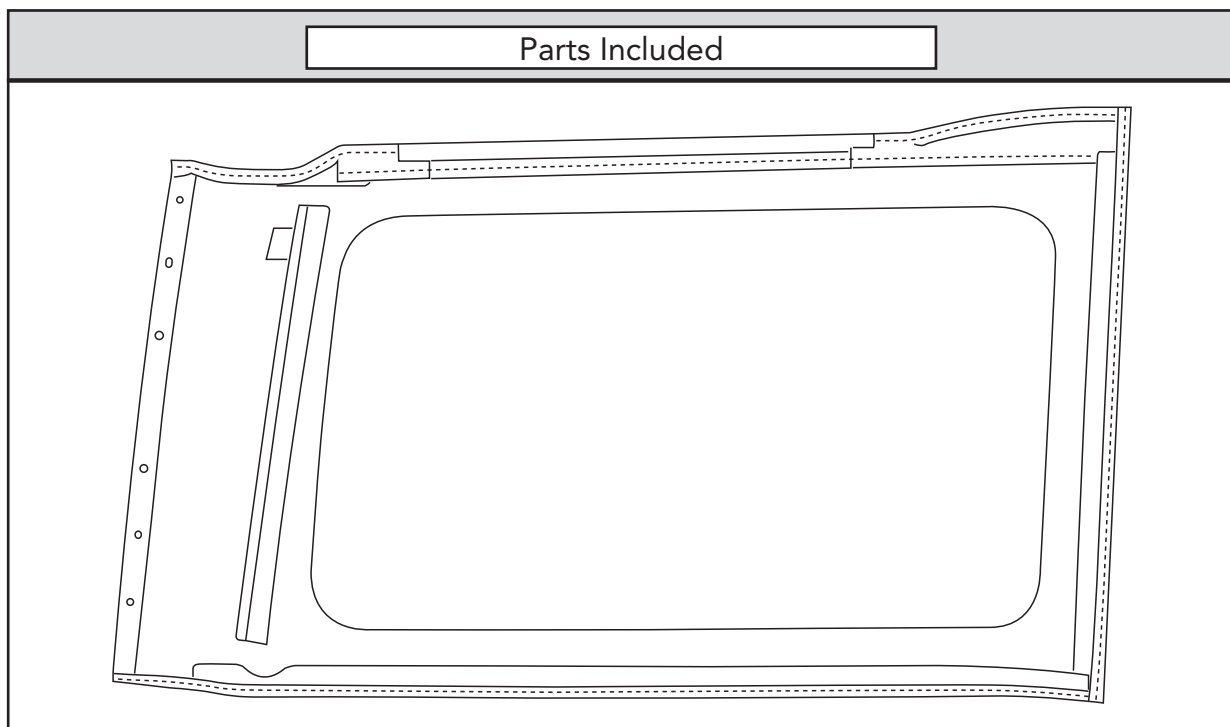

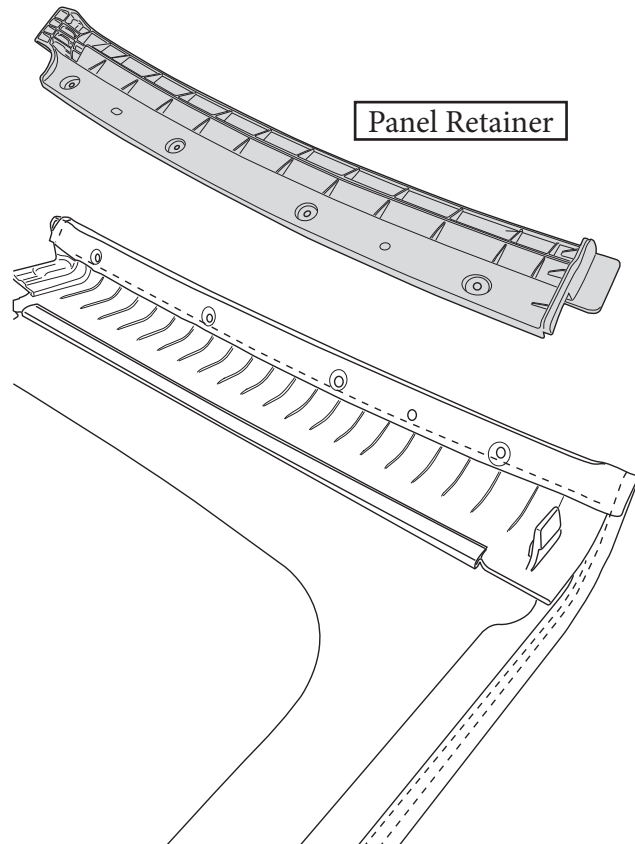
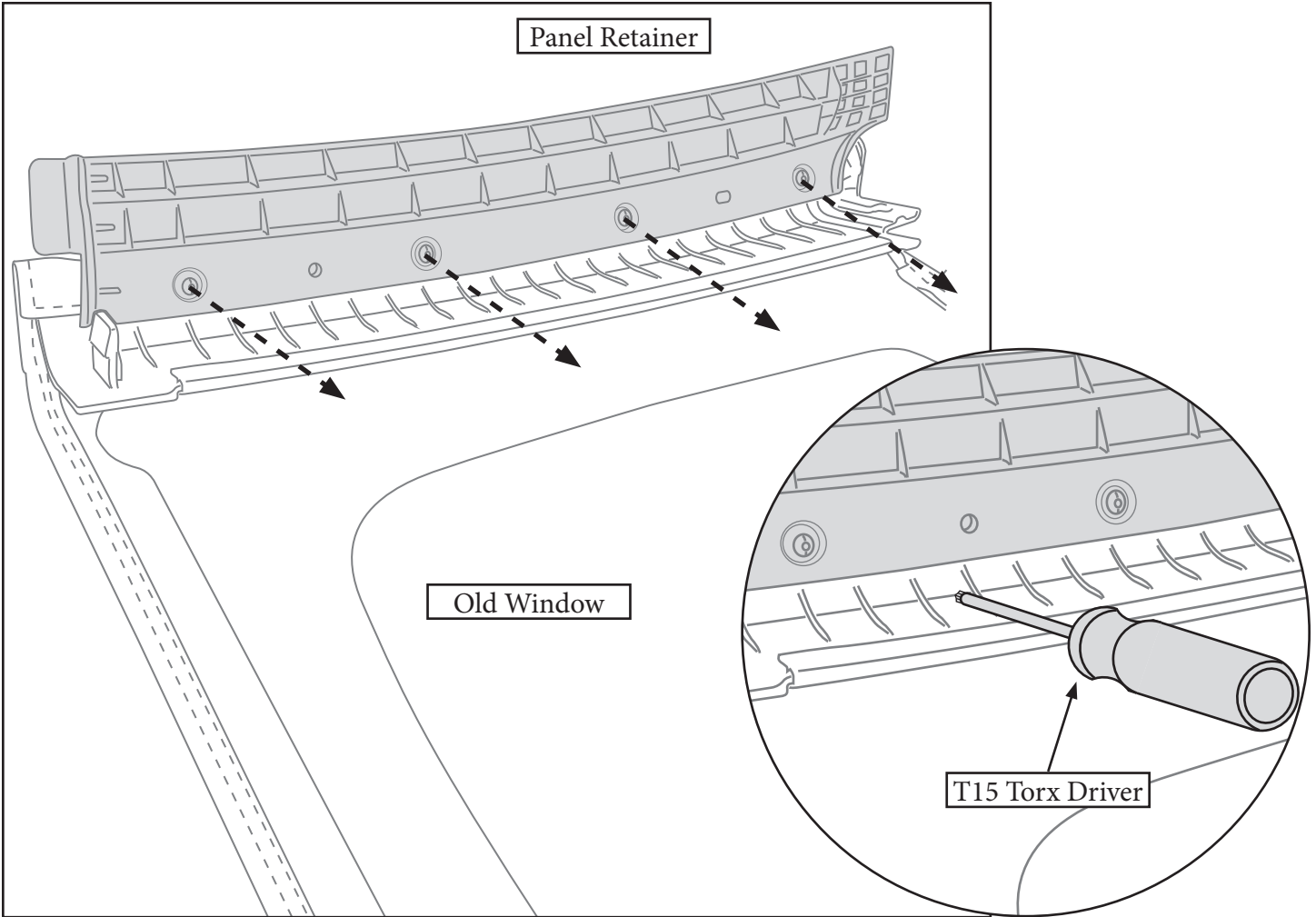

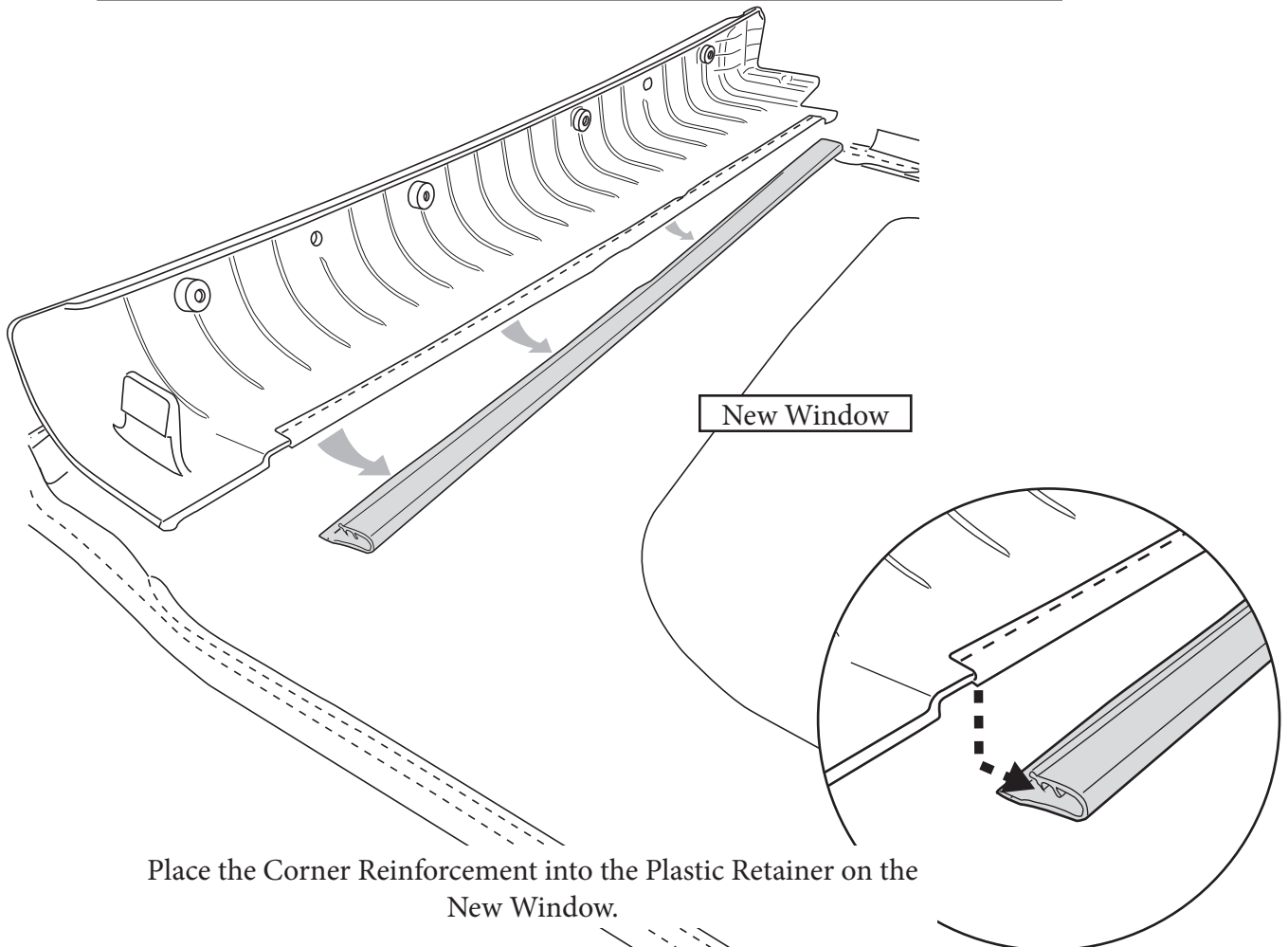
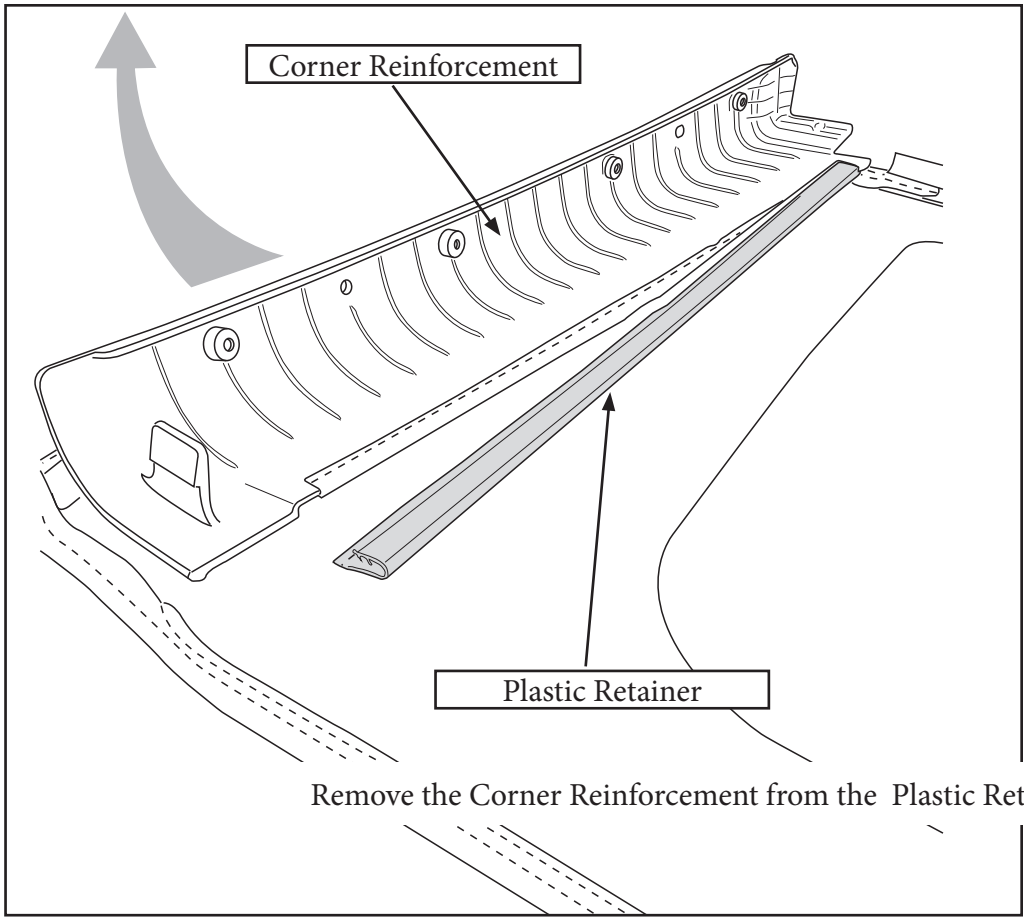

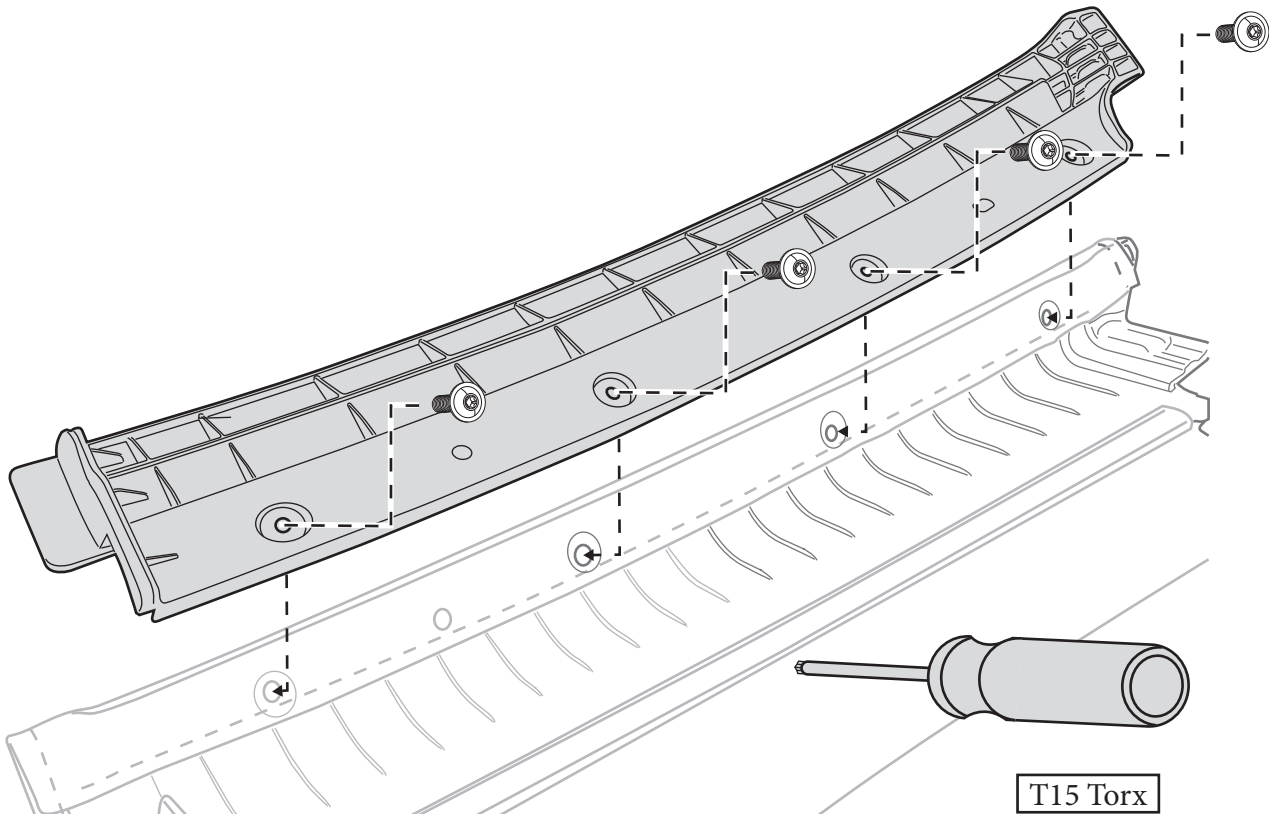
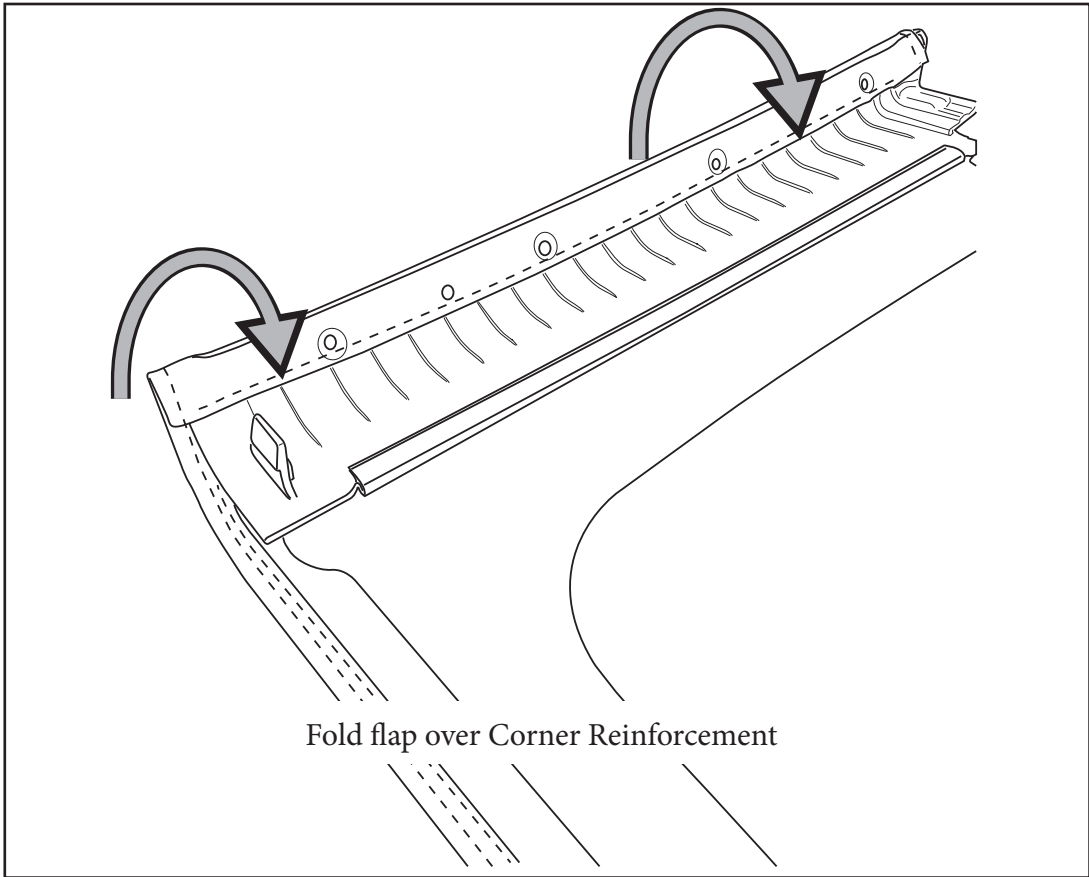



Care and Maintenance of your Bestop Product

Your Bestop product is made of the finest materials available. To keep it looking new and for the maximum possible wear, it will need periodic cleaning and maintenance.

Fabric: The fabric should be washed often using soap, warm water and a soft bristle brush. Rinse with clear water to remove all traces of soap. Bestop recommends using Bestop Cleaner (part no. 11201-00) and Bestop Protectant (part no. 11202-00) for Vinyl fabric and Bestop Twill Protectant (part no. 11207-00) for Twill fabric. Bestop Cleaner and Bestop protectant are specially formulated to provide a total cleaning and protection system. Bestop Cleaner safely removes the toughest stains, will not harm vehicle finishes, is biodegradable and environmentally friendly. Bestop Protectant protects against UV-fading, cracking and hardening, and repels dust, grease, dirt and mildew.

Windows: Keep windows clean to avoid scratching. **DO NOT** use a brush on the windows! Wash with a water-soaked cloth or sponge and a mild dishwashing detergent. Bestop recommends Bestop Vinyl Window Cleaner (part no. 11203-00), which safely cleans and protects vinyl windows and helps prevent UV damage. **NEVER WIPE THE WINDOWS WHEN THEY ARE DRY.** Be careful when cleaning snow or frost from the vinyl windows since they are easily scratched and may crack at low temperatures. **DO NOT** roll the sides or rear window in cold weather. The windows become stiff and will crack. Cracks caused by misuse in cold temperatures are not covered under warranty.

Water: Seeping through at the seams may be stopped by applying 3-M Scotchgard® on the inside of the seams.

Snaps: Keep snaps cleaned and lubricated with silicone to help prevent snaps from sticking to the studs. If a snap does become stuck to a stud, use a screwdriver and **GENTLY** pry apart to prevent permanent damage to the snap or the top fabric.

Zippers: Keeping zippers cleaned and lubricated with Bestop's Zipper Cleaner (part no. 11206-00) will help prevent damage and keep the zippers in smooth working condition. If a zipper opens behind the slider, the slider may have been spread apart. This problem can usually be repaired by using an ordinary pair of pliers to bring the sides back into parallel. Return slider to the end of the zipper in the normal Open position. Squeeze lightly at first and test the zipper. If the zipper continues to remain open squeeze more firmly with the pliers and try the zipper again. Repeat this procedure until the zipper operates correctly.

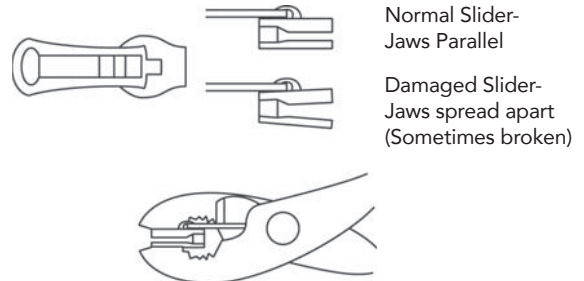

For Bestop Warranty Information, Please go to;
<https://www.bestop.com/help/warranty-information/>

