



INSTALLATION MANUAL
MATRIX FRONT BUMPER NO SENSOR
PRODUCT NUMBER: X566X-IM & X565X-IM
APPLICATION: 2022 CHEVROLET 1500



IMPORTANT SAFETY GUIDE | Your safety and the safety of others is very important.

In order to help you make informed decisions about safety, we have provided the following warnings, safety precautions, installation instructions, and other important information to alert you to potential hazards that could hurt you or others.

Please do a job safety analysis before each task to identify potential hazards for your situation and remove/protect against them. Use own good judgment and take your time.

Check packaged materials immediately upon arrival to ensure that all listed parts are included and undamaged.

Read and understand all warnings, safety precautions, and instructions before installing this product.

SENSORS FIELD OF VIEW MAY BE ALTERED WITH USE OF THE REPLACEMENT BUMPER.

WARNINGS

- Failure to observe the following warnings and instructions provided in this manual could lead to severe injury and/or death.
- For professional installation only. Careless installation and/or operation can result in serious injury, death, and/or equipment damage. All liability for installation and use rests with the user or consumer.
- Fab Fours, Inc. only approves installing this product according to these written instructions with the hardware provided. Failure to install according to these instructions will invalidate the warranty. This includes, but is not limited to, using alternative installation methods, hardware, or materials.
- This product is for off road use only.

SAFETY PRECAUTIONS

- Always remove jewelry and wear eye protection.
- Always use extreme caution when jacking up a vehicle for work. Set emergency brake and use tire blocks. Locate and use the vehicle manufacturers designated lifting points. Use jack stands.
- Always use appropriate and adequate care in lifting components into place.
- Always ensure components will remain secure during installation and operation.
- Always wear safety glasses when installing this kit. A drilling operation will cause flying metal chips. Flying chips can cause serious eye injury.
- Always use extreme caution when drilling a vehicle. Always disconnect power before welding. Thoroughly inspect the area to be drilled (on both sides of material when possible) prior to drilling, and relocate any objects that may be damaged.
- Always use extreme caution when welding a vehicle. Thoroughly inspect the area to be welded (on both sides of material when possible) prior to welding, and relocate any objects that may be a fire hazard. When welding in a cab, make sure the interior surfaces are covered (e.g., welding blanket) and a fire extinguisher is at hand.
- Always use extreme caution when cutting and trimming during fitting.
- Always tighten all nuts and bolts securely per installation instructions.
- Always route electrical cables carefully. Avoid moving parts, components that become hot, and rough or sharp edges.
- Always insulate and protect all exposed wiring and electrical terminals.
- Perform regular inspections and maintenance on mounts and hardware.

TABLE OF CONTENTS

2	SAFETY / DISCLAIMER
3	TABLE OF CONTENTS
4	A MESSAGE FROM THE OWNER
4	GETTING STARTED
6	PROVIDED MATERIAL
7	INSTALLATION
17	CONTACT

A MESSAGE FROM THE FOUNDER



Fab Fours' was born out of a passion for customizing vehicles and a love of the outdoors. Our engineering team uses the latest 3D design software to turn new product ideas into reality. In our factory, designs come to life with the combination of cutting edge technology for metal cutting and forming and an American workforce that puts its' heart and pride into every product.

From design and manufacturing, to quality and delivery, Fab Fours' mission is to be the market leader for steel truck and jeep accessories. We make sure a quality product is delivered on time, more than expected, better than expected to our customers.

Enjoy your new Fab Fours product. Welcome to the family!

Greg Higgs

FOUNDER, FAB FOURS

GETTING STARTED

Before you begin the installation process of your new Fab Fours product, we suggest laying out all materials and parts on a pad or protective surface.

Failure to fully account for all components before beginning installation may leave vehicle immobile until part is acquired. Refer to the next pages as an inventory check.

PROVIDED MATERIALS

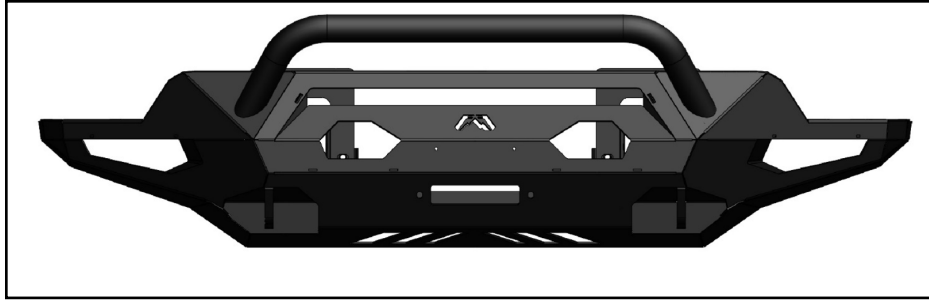

22837 - BUMPER SHELL

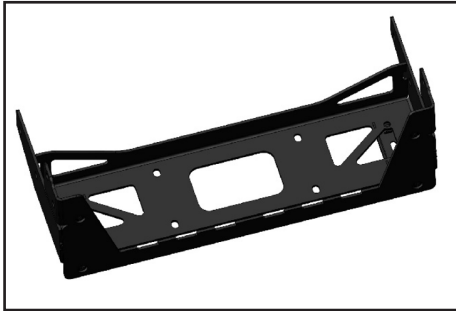

22985



21871-10

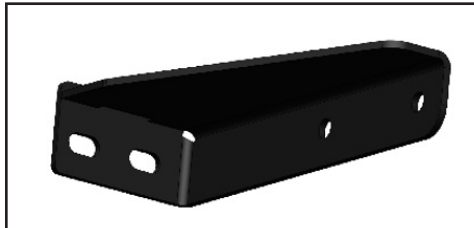

22838

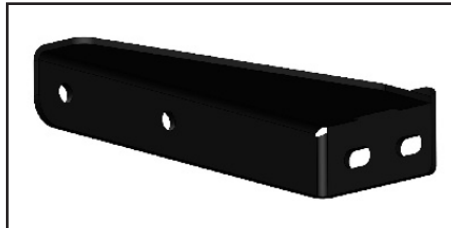

22839



TOOLS REQUIRED

- T15 TORX
- PANEL PRY TOOL
- 7MM SOCKET WRENCH
- 10MM SOCKET WRENCH
- 15MM SOCKET WRENCH
- 18MM SOCKET WRENCH
- 7/16" SOCKET AND COMBINATION WRENCH
- 1/2" SOCKET AND COMBINATION WRENCH
- 3/4" SOCKET AND COMBINATION WRENCH

ASSISTANCE

We recommend two people perform the installation as items are heavy and may need to be held in place while installing.

ORGANIZATION

Disassemble the vehicle where you can catalog and store everything. We suggest labeling and bagging all the OEM bolts when removing from the vehicle. Failure to keep track of parts could lead to an inability to properly reinstall components.

HARDWARE KIT | 50358-HW

FAB FOURS IDENTIFICATION	COMPONENT DESCRIPTION	QTY
50358-HW	1/2"-13 X 1.25", YELLOW-ZINC, GRADE 8, HEX HEAD CAP SCREW	12
50358-HW	1/2", SAE, YELLOW-ZINC, GRADE 8, LOCK WASHER	16
50358-HW	1/2", SAE, YELLOW-ZINC, GRADE 8, FLAT WASHER	24
50358-HW	1/2"-13, YELLOW-ZINC, GRADE 8, HEX NUT	8
50358-HW	1/2"-13 X 4", YELLOW-ZINC, GRADE 8, HEX HEAD CAP SCREW	4
50358-HW	1/4"-20 X 1", YELLOW-ZINC, GRADE 8, HEX HEAD CAP SCREW	2
50358-HW	1/4"-20, YELLOW-ZINC, GRADE 8, HEX NUT	2
50358-HW	1/4"-SAE, YELLOW-ZINC, GRADE 8, FLAT WASHER	4
50358-HW	1/4"-SAE, YELLOW-ZINC, GRADE 8, LOCK WASHER	2
50358-HW	5/16"-18X 1.0", YELLOW-ZINC, GRADE 8, HEX HEAD CAP SCREW	4
50358-HW	5/16", YELLOW-ZINC, GRADE 8, LOCK WASHER	4
50358-HW	5/16", YELLOW-ZINC, GRADE 8, FLAT WASHER	4

INSTALLATION

1. Using a T15 Torx bit remove the two (2) screws in the hood latch handle to remove it. (Figure 1)

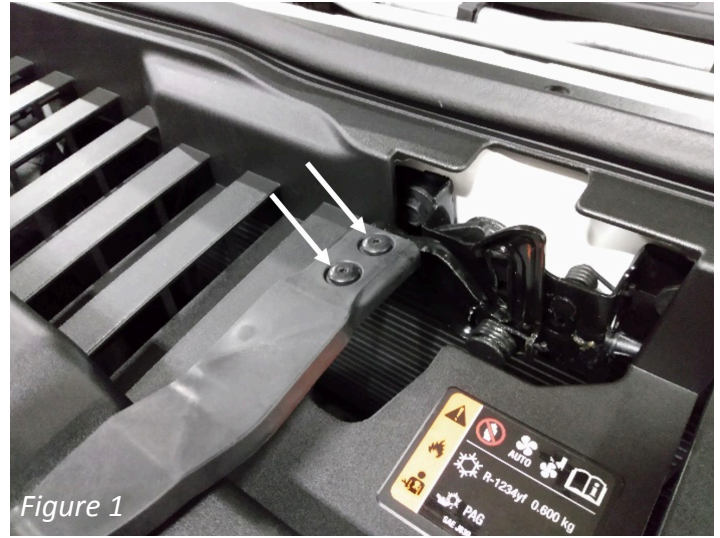

2. Using a panel pry tool, remove the nine (9) push pins in the under-hood cowl to remove it. (Figure 2)



3. Using a 10mm, remove the four (4) screws across the top of the grille. (Figure 3)



Figure 3

4. Using a T15 Torx, remove the six (6) lowest forward most screws in each front inner fender. (Figure 4-5)



Figure 4



Figure 5

5. Starting on one side of the vehicle, pull outward on the valence to release the clips which attach it.

The seam where the valence meets the fender has six (6) clips, using a panel pry tool you can help release these clips while pulling outward on the valence.

Once the seam clips are released there are several other clips along the valence that can be released simply by pulling outward. (Figure 6-7)



Figure 6



Figure 7

6. Now the grille can be removed by pulling outward on the pieces over the headlights which have two (2) clips first then on the center which has three (3) clips. (Figure 8)



Figure 8

7. Using a 10mm socket wrench, remove the nine (9) screws along the perimeter of the upper louvers. Then, release the two (2) electrical connectors on the driver's side to remove the louvers. (Figure 9-10)



Figure 9

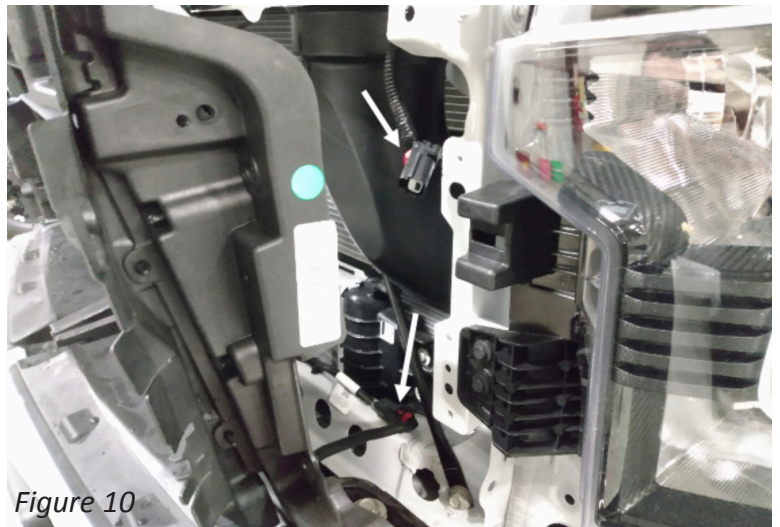

Figure 10

8. Using an 18mm socket wrench, remove the two (2) bolts along the top of the bumper. (Figure 11)



Figure 11

9. Using an 18mm socket wrench, remove the two (2) bolts between the frame rails behind the bumper. (Figure 12)



Figure 12

10. Using a 15mm socket wrench, remove the three (3) bolts per side holding the bumper supports to the frame and bumper. (Figure 13)

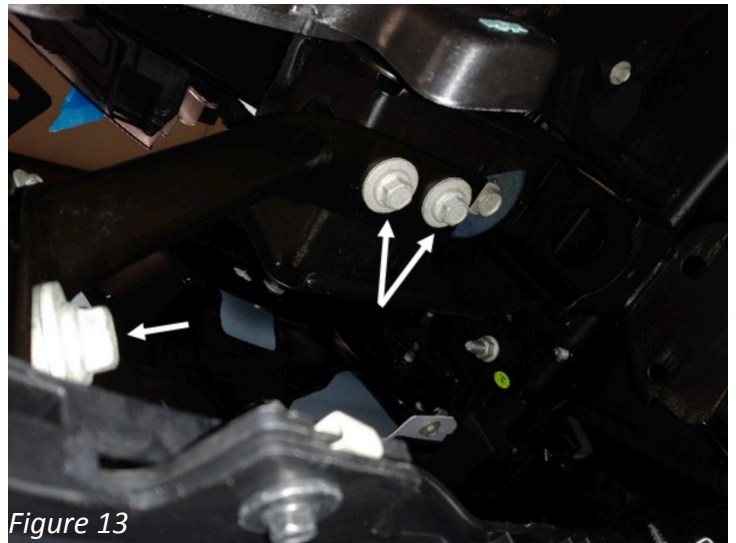

Figure 13

11. Using a 10mm socket wrench, remove the four (4) screws per side holding the bumper supports to the frame and bumper. The bumper can now be removed from the vehicle. (Figure 14)

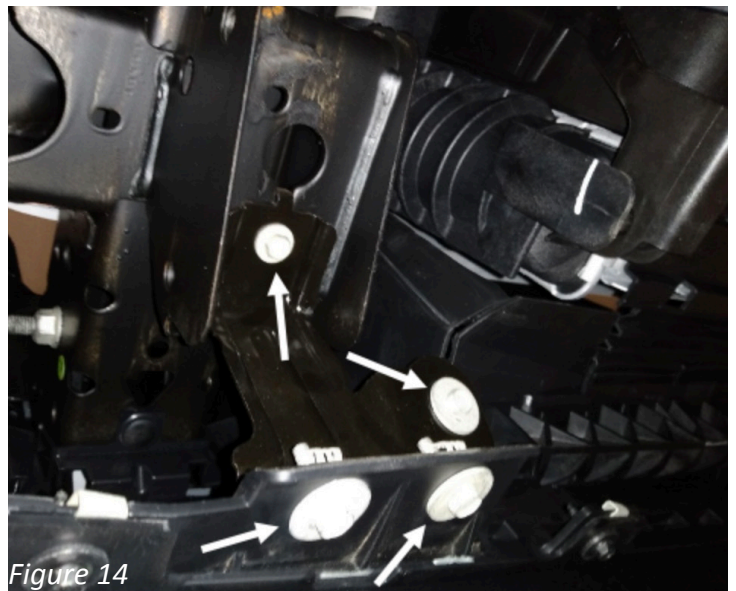
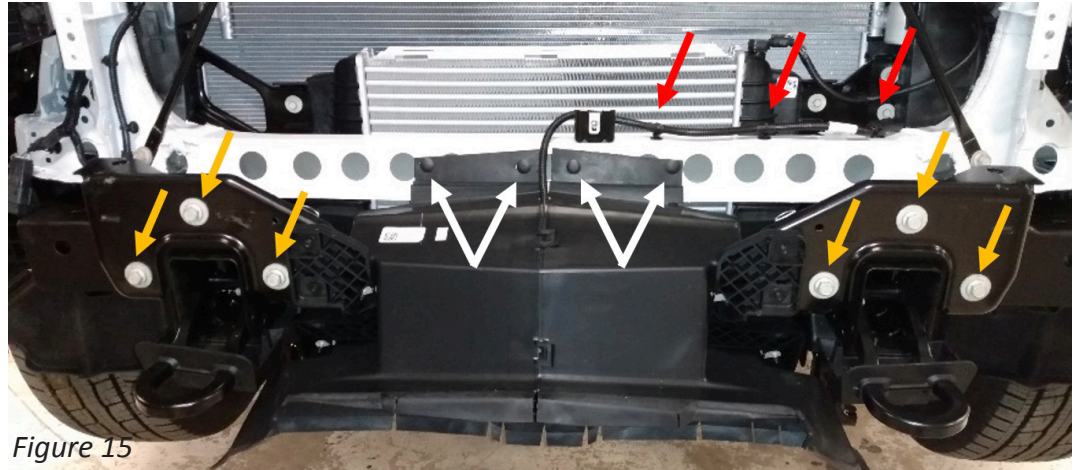

Figure 14

****Note: Steps 12-13 only apply to vehicles with lower louvers. ****

12.* Using a panel pry tool, remove the four (4) push pins from the lower louver shroud and the three (3) clips attaching the harness to the vehicle. Then, using a 15mm socket wrench remove the six (6) bolts in the frame horns to release the louvers from the frame. (Figure 15)



13.* Using a 7mm socket wrench, remove the six (6) screws that attach the louvers to the louver shroud. Then, using a panel pry tool remove the clip holding the harness to the louvers. (Figure 16-17)

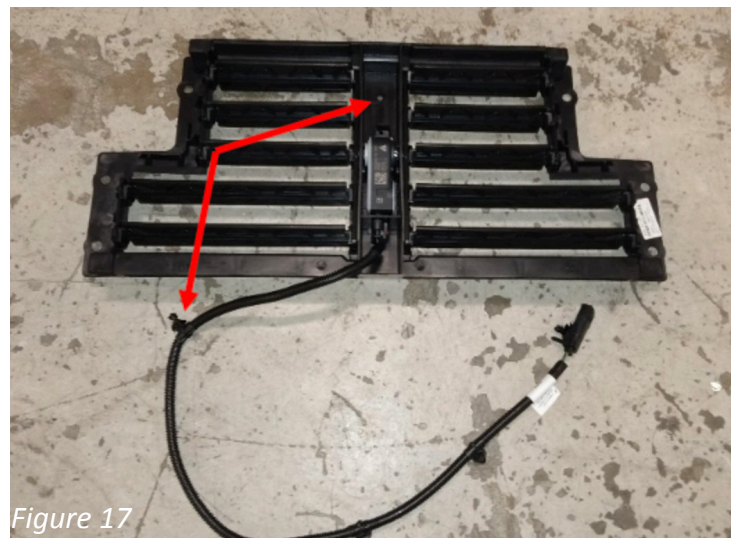

14. Using an 18mm socket wrench and combination wrench, remove the two (2) bolts attaching each tow hook to the frame to remove them. (Figure 18)



Figure 18

15. Reinstall the previously removed upper louver set by reversing the steps used to remove it.
16. Reinstall the previously removed grille by reversing the steps used to remove it.
17. Reinstall the previously removed valence by reversing the steps used to remove it.
18. Reinstall the previously removed under hood cowl by reversing the steps used to remove it.
19. Reinstall the previously removed hood latch handle by reversing the steps used to remove it.
20. Reinstall the previously removed inner fender hardware by reversing the steps used to remove it.

21. Prepare the new bumper (Part#: 22837) for installation by installing lights. Use the two (2) provided L-brackets (Part#: 21871-10) along with the two (2) provided 1/4" screws, flat washers, lock washers, and nuts (50358-HW) to install the 30" lightbar along with manufacture supplied hardware. (Figure 19)

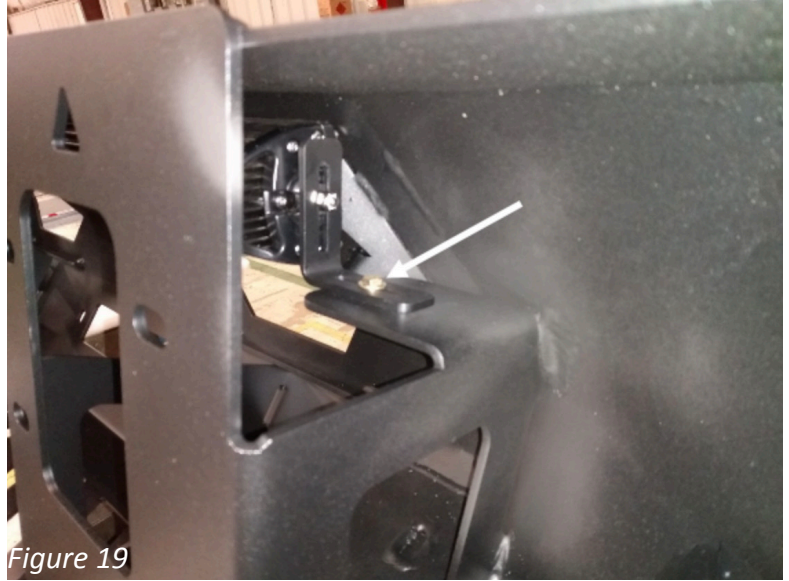

Figure 19

22. If installing a winch, do so now with the winch manufactures instructions and hardware to the provided winch tray (Part#: 22985). (Figure 20)



Figure 20

23. Using the four (4) provided 1/2"-13 x 4" bolts, flat washers, lock washers, and nuts, install the provided winch tray (Part#: 22985) and frame gussets (DS Part#: 22838, PS Part#: 22839) through the under-run guards on the bottom of the frame rails. (Figure 21)

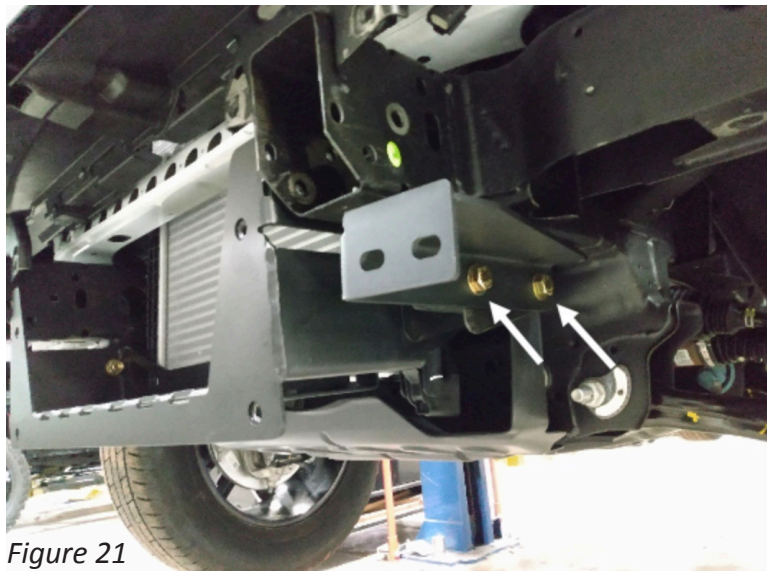

Figure 21

24. Install the four (4) provided 1/2"-13 x 1.25" bolts, flat washers, lock washers, and nuts into the top four (4) holes in the winch tray. (Figure 22)



Figure 22

25. Use a 3/4" socket and combination wrench to tighten the previously installed 1/2" hardware.

26. Install the lower louver set to the bottom of the winch tray using a 1/2" socket wrench and the four (4) provided 5/16" bolts, flat washers, and lock washers. Then, route the wiring harness in a safe place up to its connector and plug it back in. (Figure 23)



Figure 23

27. Install new bumper (Part#: 22837) to the vehicle by reinstalling four (4) of the previously removed OE bolts and eight (8) of the provided 1/2"-13 x 1.25" bolts, flat washers, and lock washers. (Figure 24)

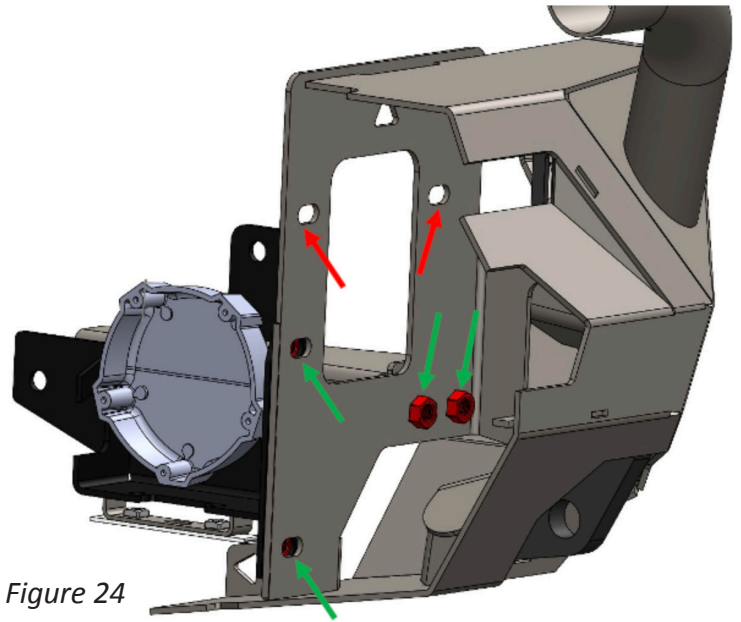

Figure 24

28. Tighten the previously installed OE hardware with an 18mm socket wrench, and the provided 1/2" hardware with a 3/4" socket wrench.

INSTALLATION COMPLETE

CONTACT INFORMATION



**FAB FOURS INC.
2213 INDUSTRIAL PARK ROAD
LANCASTER, SC 29720**

**PHONE: (866) 385-1905
FAX: 970-385-1914
EMAIL: SUPPORT@FABFOURS.COM
FABFOURS.COM**