

INSTALLATION INSTRUCTIONS

Congratulations - your new Air Helper Springs are quality products capable of improving the handling and comfort of your vehicle. As with all products, proper installation is the key to obtaining all of the benefits your kit is capable of delivering. Please take a few minutes to read through the instructions to identify the components and learn where and how they are used. It is a good idea to start by comparing the parts in your kit with the parts list below.

The heart of the kit is, of course, the air helper springs. Remember that the air helper springs must flex and expand during operation, so be sure that there is enough clearance to do so without rubbing against any other part of the vehicle.

Be sure to take all applicable safety precautions during the installation of the kit. The instructions listed in this brochure and the illustrations all show the left, or driver's side of the vehicle. To install the right side assembly simply follow the same procedures.

PARTS LIST

AIR SPRING	6868	2	3/8"-16 LOCK NUT	6	
UPPER LEFT BRACKET	5506	1	5/16" X 5 1/2" X 2 1/4" BAIL CLAMP	4	
UPPER RIGHT BRACKET	5507	1	5/16"-18 LOCK NUT	8	
LOWER LEFT BRACKET	5508	1	3/8"-16 NUT PLATE	2	
LOWER RIGHT BRACKET	5509	1	5/8"-18 JAM NUT	2	
LEFT U-BOLT CLAMP	5510	1	5/16" FLAT WASHER	4	
RIGHT U-BOLT CLAMP	5511	1	18 ft. TUBING	0938	1
BRACKET CLAMP	5181	2	INFLATION VALVE	3032	2
HEAT SHIELD		1	STRAIGHT FITTING	3055	2
EXHAUST CLAMP		2	THERMAL SLEEVE	0899	2
3/8"-16 X 5 1/2" CARRIAGE BOLT		6	NYLONTIE		8
3/8"-16 X 1" HEX BOLT		2	CAUTION TAG		2
3/8"-16 X 5/8" FLAT HEAD BOLT		2			

WARNING:

Do not inflate this assembly when it is unrestricted. The assembly must be restricted by the suspension or other adequate structure. Do not inflate beyond 100 psi. Improper use or over inflation may cause property damage or severe personal injury.

This kit includes inflation valves and air lines for each air spring. This will allow you to compensate for unbalanced loads. If you would rather have a single inflation valve system to provide equal pressure to both air springs, your dealer can supply the optional "T" fitting.

IMPORTANT!

For your safety and to prevent possible damage to your vehicle, do not exceed the maximum load recommended by the vehicle manufacturer (GVWR). Although your Air Helper Springs are rated at a maximum inflation pressure of 100 psi, this pressure may allow you to carry too great a load on some vehicles. It is best to have your vehicle weighed once it is completely loaded and compare that weight to the maximum allowed. Check your vehicle owner's manual or data plate on driver side door for maximum loads listed for your vehicle.

When inflating your Air Helper Springs, add air pressure in small quantities, checking pressure frequently during inflation. The air spring requires much less air volume than a tire and, therefore, inflates much quicker.

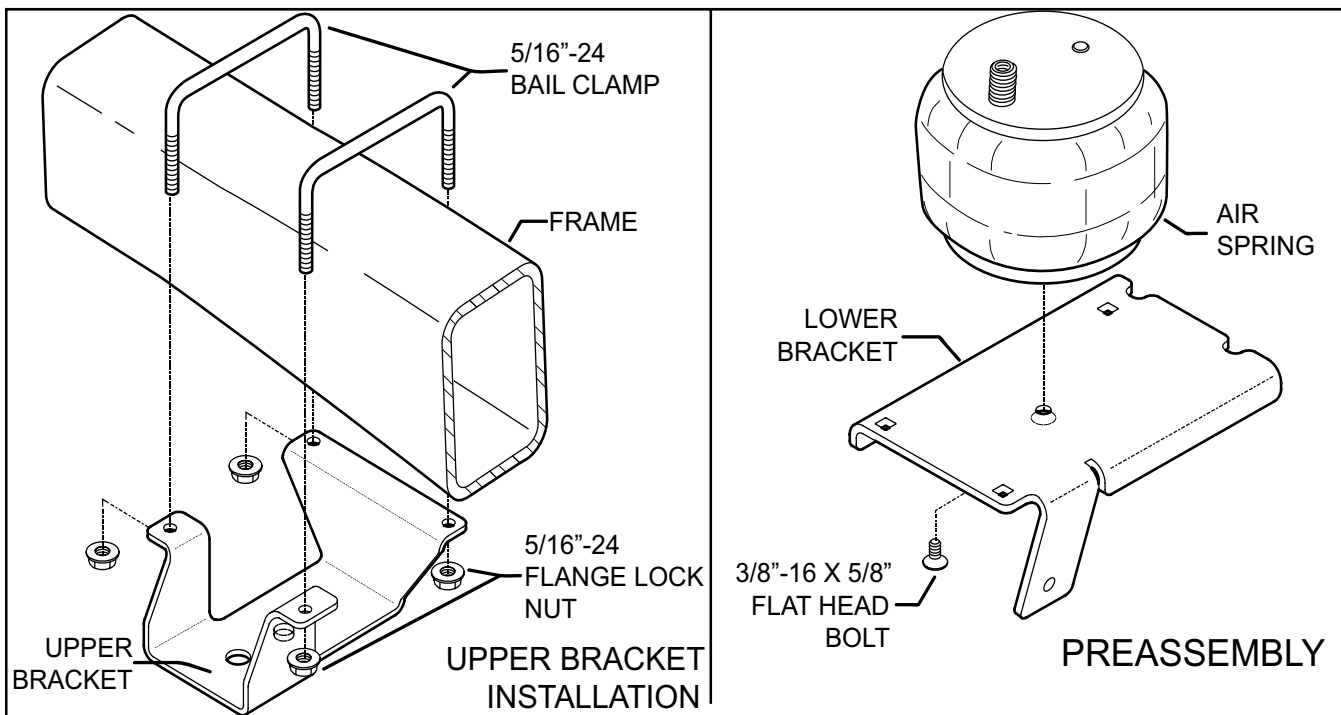

Illustration is of the right, or passenger side of the vehicle. Repeat instructions for the left, or driver's side.

IMPORTANT!:
SEE FLYER FOR
HEAT SHIELD INSTALLATION

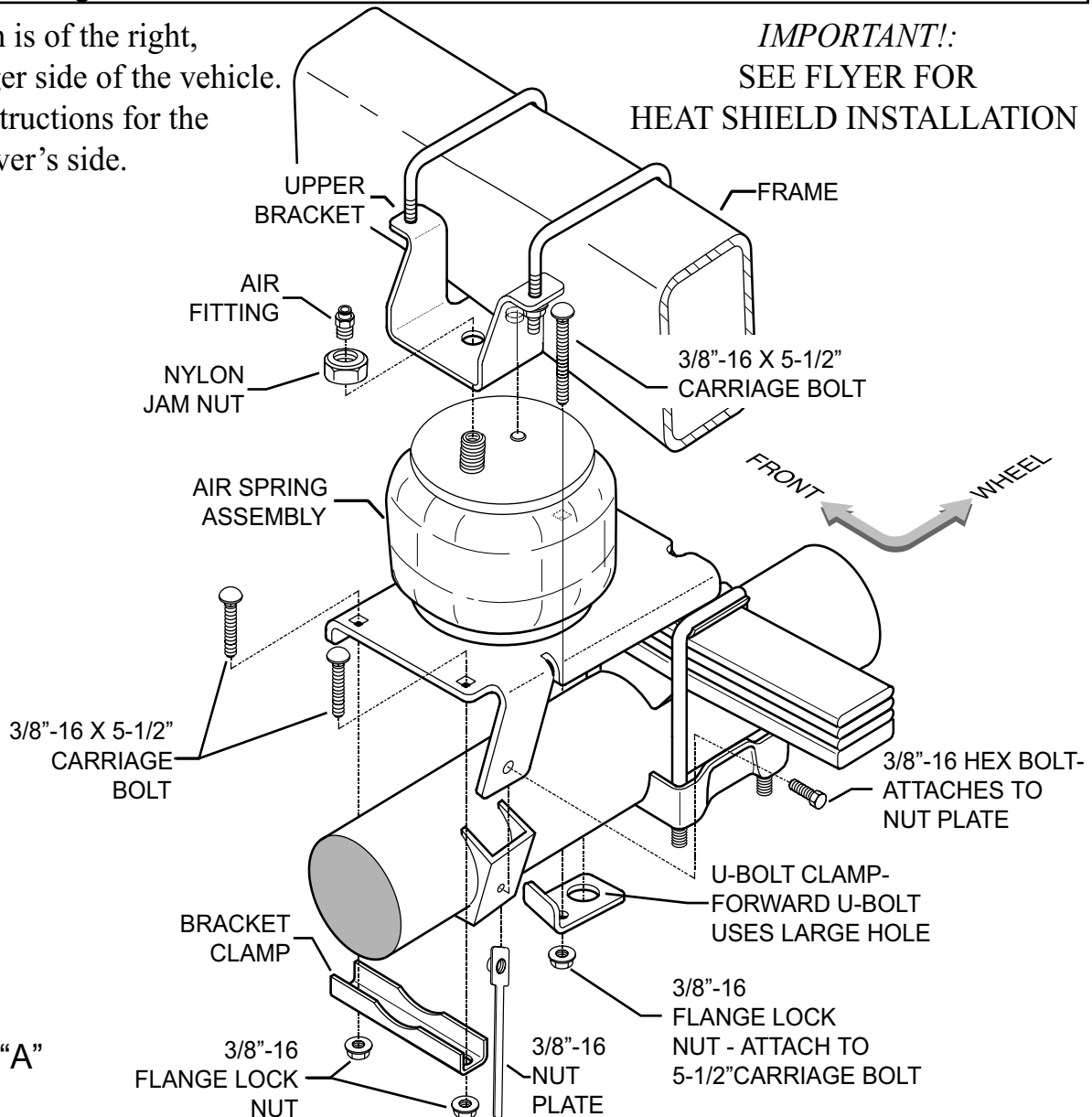

FIGURE "A"
2423

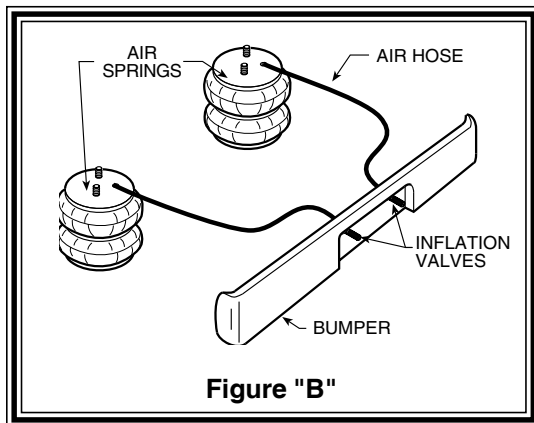

Figure "B"

STEP 1 - PREPARE THE VEHICLE

With the vehicle on a solid, level surface chock the front wheels. Raise the vehicle by the rear axle and remove the rear wheels. After the removal of the wheels lower the vehicle so the axle rests on jack stands rated for your vehicles weight. Make sure the negative battery cable is disconnected from the battery.

STEP 2 - PREASSEMBLE

Select one air helper spring from your kit and the lower right bracket. Use the 3/8"-16 flat head bolt to secure the bracket to the air spring. *See Figure "A"*.

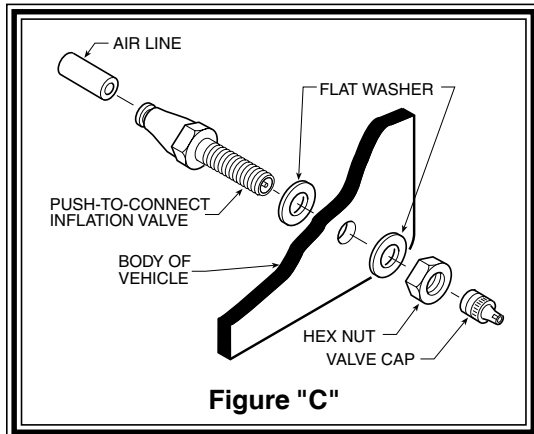

Figure "C"

Next, select the upper right bracket, two bail clamps, and four 5/16" lock nuts. Place the upper bracket on the frame centered over the axle as shown in *Figure "A"*. Install the bail clamps over the frame and through the holes in the upper bracket and loosely fasten the 5/16" lock nuts. *See Figure "A"*.

STEP 3- INSTALLATION TO THE VEHICLE

Place the air spring assembly on the axle and under the upper bracket. Insert the large stud into the larger hole and the alignment pin into the smaller hole. Install the Nylon jam nut onto the air spring stud then install the air fitting. Tighten the air fitting securely to engage the orange thread sealant. *See Figure "A"*.

Next, make sure the lower bracket is level on the axle and, using the bracket as a template, drill a 7/16" hole in the shock mount on the axle as shown in *Figure "A"*. Position the nut plate inside the shock mount and install the 1" hex bolt affixing the lower bracket to the axle.

Place one of the 5 1/2" carriage bolts into the square hole closest to the leaf spring stack. Select the right-side U-bolt clamp and place it on the vehicle so the large hole is around the forward-most axle U-bolt and the carriage bolt inserts into the small hole. Install and tighten one 3/8" lock nut. *See Figure "A"*.

Next place two of the 5 1/2" carriage bolts into the remaining square holes on the lower brackets. Place the bracket clamp onto the carriage bolts from under the axle then install and tighten two 3/8" lock nuts as shown in *Figure "A"*.

Tighten the 5/16" lock nuts on the bail clamp and make sure all brackets are secure.

NOTE: On the right, or passenger's side of the vehicle, a heat shield is required. Please see the heat shield flyer for proper installation.

STEP 4- INSTALLATION OF THE DRIVER'S SIDE ASSEMBLY

Follow steps 1-4 for assembly and installation of the driver's side assembly.

NOTE: On the left, or driver's side of the vehicle, use some of the provided nylon ties to secure the factory installed wire loom out of the way to assist in installation.

STEP 5- INSTALL THE AIR LINE AND INFLATION VALVE

Uncoil the air tubing and cut it into two equal lengths. **DO NOT FOLD OR KINK THE TUBING.** Try to make the cut as square as possible. Insert one end of the tubing into the air fitting installed in the top of the air helper spring. Push the tubing into the fitting as far as possible refer to *Figure "A"*.

Select a location on the vehicle for the air inflation valves. The location can be on the bumper or the body of the vehicle, as long as it is in a protected location so the valve will not be damaged, but maintain accessibility for the air chuck (see *Figure "B"*). Drill a 5/16" hole and install the air inflation valve using two 5/16" flat washers per valve as supports (see *Figure "C"*). Run the tubing from the air helper spring to the inflation valve, routing it to avoid direct heat from the engine, exhaust pipe, and away from sharp edges. Thermal sleeves have been provided for these conditions. If a thermal sleeve is required simply slide the sleeve over the air line tubing to the location requiring protection. The air line tubing should not be bent or curved sharply as it may buckle.

Secure the tubing in place with the nylon ties provided. Push the end of the air line tubing into the inflation valve as illustrated, see *Figure "C"*.

STEP 6 - CHECK THE AIR SYSTEM

Once the inflation valves are installed inflate the air helper springs to 70 *psi.* and check the fittings for air leaks with an applied solution of soap and water. If a leak is detected at a tubing connection then check to make sure that the tube is cut as square as possible and that it is pushed completely into the fitting. The tubing can easily be removed from the fittings by pushing the collar towards the body of the fitting and then pulling out the tube. If a leak is detected where the brass elbow fitting screws into the spring, remove the tubing (see trouble shooting section of the operating instruction manual for removal procedure), then screw the elbow into the spring one additional turn or until the leak stops. Reinstall the tubing and reinflate the air springs and check for leaks as noted above.

This now completes the installation. Install the wheels and torque the lug nuts to the manufactures specifications. Raise the vehicle by the rear axle and remove the jack stands and lower the vehicle back onto the ground. Re-attach the negative battery cable and remove the wheel chocks from the front wheels. Before proceeding, check once again to be sure you have proper clearance around the air springs. With a load on your vehicle and the air helper springs inflated, you must have at least 1/2" clearance around the air springs. As a general rule, the air helper springs will support approximately 40 lbs. of load for each *psi.* of inflation pressure (per pair). For example, 50 *psi.* of inflation pressure will support a load of 2000 lbs. per pair of air helper springs. *FOR BEST RIDE* use only enough air pressure in the air helper springs to level the vehicle when viewed from the side (front to rear). This amount will vary depending on the load, location of load, condition of existing suspension and personal preference.

NOTE:

Too much air pressure in the air helper springs will result in a firmer ride, while too little air pressure will allow the air helper spring to bottom out over rough conditions. Too little air pressure will also not provide the improvement in handling that is possible. ***TO PREVENT POSSIBLE DAMAGE MAINTAIN A MINIMUM OF 5 *psi.* IN THE AIR HELPER SPRINGS AT ALL TIMES.***

NOTE:

Once the air helper springs are installed, it is recommended that the vehicle not be lifted by the frame, as over-extension may occur, resulting in damage to the air helper springs. However, should it become necessary to raise the vehicle by the frame, deflate both air helper springs completely.

NOTE:	
MIN PRESSURE	5 PSI
MAX PRESSURE (LOADED)	100 PSI



PARTS LIST

DESCRIPTION	QTY.
HEAT SHIELD	1
CLAMPS	2

STEP 1

Bend the heat shield middle tab out at a 90 degree angle and bend the heat shield again half the distance up the tab at a 90 degree angle to form a "L" shape refer to *Figure "A"*.

STEP 2

Mount the heat shield between the air spring and the exhaust pipe. Mount the heat shield using the clamps provided see *Figure "B"*. **Maintain clearance between heat shield and moving axle, lines, etc...**

STEP 3

Bend the heat shield around the exhaust pipe, while allowing for open air space of 1/2" to 1" as shown in *Figure "C"*.

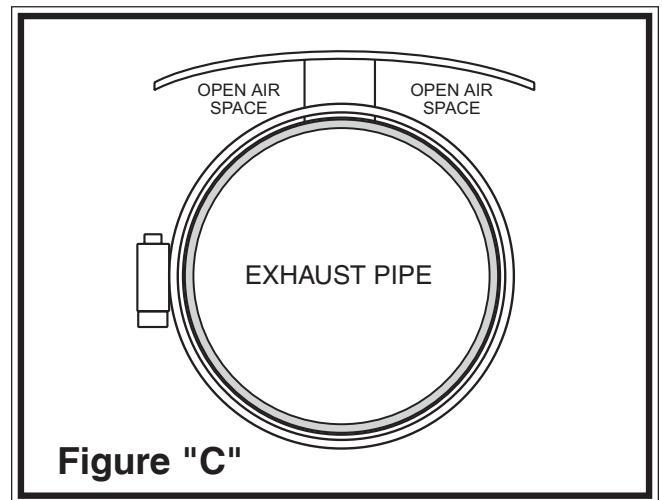
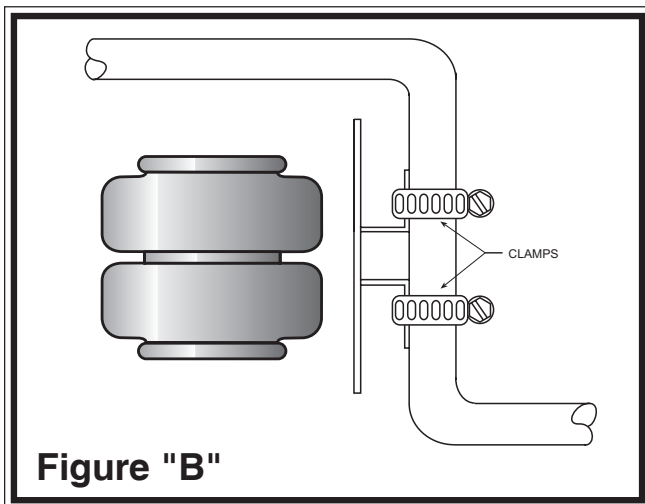
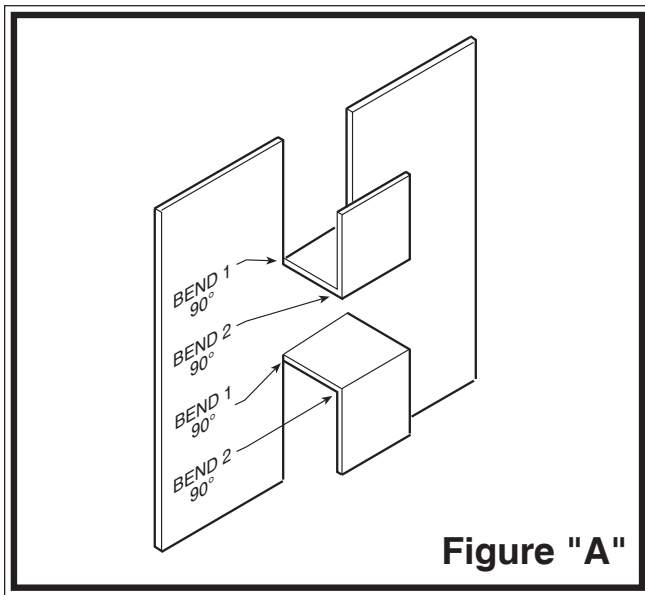

Firestone

**World's Number 1
Air Spring.**



FIRESTONE INDUSTRIAL PRODUCTS COMPANY



Operating Instructions and Trouble Shooting Guide

Thank you for purchasing Firestone air helper springs. You have purchased a quality product from the world's number one air spring manufacturer.

This guide will provide answers to some of your questions regarding the use and operation of your new air helper springs. Following the guidelines in this manual will help provide you with many years of trouble-free service from your Firestone air helper springs.

For vehicle applications, air pressure requirements, air compressor CFM, maintenance, or air spring technical data, contact us at:

**www.ride-rite.com
1-800-888-0650**

INSTALLER: Please leave this manual with the vehicle's owner.

WARRANTY QUESTIONS

Go to **www.riderite.com/installation-support**
Select "Warranty Info" tab

SAFETY TIPS

Never exceed the manufacturer's recommended Gross Vehicle Weight Rating (GVWR)

As with your vehicle's tires, an air helper spring is a pneumatic device that supports a portion of the vehicle's weight. The air helper spring may fail as a result of punctures, impact damage, improper inflation, improper installation, or improper usage. To reduce the risk of failure, we strongly recommend the following:

Never overload your vehicle. The manufacturer's gross vehicle weight rating (GVWR) is stated on the specification plate on the chassis. You should weigh your vehicle on a truck scale when it is fully loaded and in a level condition to determine if you are exceeding the manufacturer's recommended GVWR.

Inspect the inflated air springs to verify that they do not contact any component of the vehicle under normal suspension operation. The air helper spring must flex and expand during normal operation. There must be at least 1/2" of clearance between the inflated air spring and any other component of the vehicle under normal suspension operation.

The kit is designed to clear all chassis components. If there is **any** interference, please call Firestone at 1 (800) 888-0650.

Inspect the air line tubing and the air spring to verify that they have not been too close to the exhaust system. If the distance between any portion of the air spring or air line tubing and the exhaust system is less than 6", a heat shield should be used.

Never inflate the air helper springs beyond the maximum pressure indicated in the installation manual.

Never attempt to remove any component of the air spring assembly when the air springs are inflated.

If an air helper spring has failed while you are on the road, operate your vehicle at reduced speeds. High speed over rough roads will result in severe bottoming of the air spring and may damage other vehicle components.

Never attempt to drive the vehicle in an unlevelled condition. Failure to level a heavily loaded vehicle may result in excessive body roll and possible damage or injury.

If unidentifiable problems exist with your air helper spring kit, visit Firestone on the web at www.riderite.com or call 1 (800) 888-0650 for technical assistance.

Never cut, weld, or modify the air helper springs or brackets.

Do not use aerosol tire repair products in the air helper springs or a tire patch of any kind on the air helper spring. If there is a hole in the air spring it must be replaced.

GENERAL INFORMATION

Firestone air helper springs are heavy duty, quality air springs designed to supplement your vehicle's existing suspension system. These durable air springs allow you to maximize your vehicle's load carrying capacity through the use of air pressure. Proper installation, use, and operation will provide the maximum service life and performance your air spring kit is capable of delivering. These instructions will help you obtain the maximum benefits available from your air spring kit.

RIDE-RITE™ AIR HELPER SPRINGS

Ride-Rite™ air helper springs are installed between the frame and the suspension of trucks, vans, and motorhomes. Ride-Rite™ air helper springs are capable of supporting loads up to 5000 lbs per pair.*

SPORT-RITE™ AIR HELPER SPRINGS

Sport-Rite™ air helper springs are installed between the frame and suspension of light trucks, and utilize a sleeve-style air spring to enhance the ride when the vehicle is loaded or unloaded. Sport-Rite™ air helper springs are capable of supporting loads up to 3000 lbs per pair.*

LEVEL-RITE™ AIR HELPER SPRINGS

Level-Rite™ air helper springs replace the existing shock absorber with a fully-protected, reversible sleeve air spring paired it with a high-performance Bilstein monotube shock absorber for perfectly matched performance characteristics over the entire operation spectrum. Level-Rite™ air helper springs are capable of supporting loads up to 1000 lbs per pair.*

BASIC OPERATION

As your vehicle is loaded, the stock suspension is compressed under the weight of the load. Your vehicle's stock suspension system has been designed so that it will provide optimum performance and handling with a specific load on the vehicle. When your vehicle is loaded, its performance, handling characteristics, and ride quality may be compromised. As the stock suspension is compressed, the ride may become "mushy", and you may encounter sway and handling problems. As weight is added to the vehicle, the air helper springs become an active part of

*Do not exceed the vehicle's recommended gross vehicle weight rating (GVWR)

the suspension system. As more air pressure is added to the air springs, they will support more weight. You will be able to compensate for a heavy load by adding air pressure to the air springs, thereby reducing sway and handling problems associated with a heavily loaded vehicle.

TABLE "A"	
ALL TORQUE SPECIFICATIONS	
Using a torque wrench, torque the threaded fasteners to the following specifications:	
Fasteners used on studs and blind holes in air springs	15 – 20 ft lbs
Hex nuts installed on carriage bolts	10 – 15 ft lbs
Hex nuts installed on 3/8" hex bolts	28 – 32 ft lbs
Hex nuts and bolts used to secure brackets to frame	28 – 32 ft lbs
Hex nuts installed on U-bolts	15 – 20 ft lbs
Hex bolts securing tapered sleeve style air spring to lower bracket	10 – 12 ft lbs

PREVAILING-TORQUE LOCK NUTS

In order to assure trouble-free operation, your air spring kit includes a variety of self-locking threaded fasteners. Your kit may include prevailing-torque lock nuts. Prevailing-torque lock nuts may be more difficult to install, but will not come loose under normal suspension operation.

THREAD LOCKING COMPOUND

The hex bolts used to secure the air spring to the brackets may have a locking compound applied to the threads. Lock washers are not required when using a fastener with pre-applied thread locking compound. When installing fasteners with thread locking compound, follow the torque recommendations listed in table.

HELICAL LOCK WASHERS

Your air helper spring kit may include helical lock washers. In order to properly use the lock washer, tighten the nut/bolt fastener just enough to flatten the lock washer. Overtightening the fastener may damage the nut or bolt. When using helical lock washers, follow the torque recommendations listed in Table "A".

AIR FITTINGS

Your kit will include one of two types of push-to-connect air fittings: fittings with a thread locking compound pre-applied to the threads or fittings with a Nylon collar in place of the thread locking compound.

The pre-applied thread sealant, thread the air fitting into the air spring and tighten the fitting securely to engage the pre-applied thread sealant.

The Nylon collar, thread the air fitting into the threaded hole on the air spring so that the Nylon collar makes contact with the top of the air spring and then tighten 1/2 turn. No thread sealant is required.

Both types of air fittings allow easy connection between the air fitting and the air line tubing. To install the air line in the fittings, cut the tubing as square as possible using a sharp utility knife or razor blade. Push the air line into the fitting as far as possible. If the tubing must be removed from the fitting, first release the air pressure from the air spring. Push the collar towards the body of the fitting and then pull the tubing out.

PRESSURE DIFFERENTIAL BETWEEN AIR SPRINGS

It is not uncommon to have different pressures between the air springs after the vehicle has been brought to a level condition. If the vehicle is within the manufacturer's recommended gross vehicle weight and you have not achieved a level condition after inflating the air springs to 100 psi, there may be a problem with your stock suspension. The leaf springs may have become fatigued over time or a leaf spring may be fractured. There may be an obstruction in the air system, not allowing the air pressure to reach the air helper springs.

AIR SPRING ALIGNMENT AND HEIGHT

Upon completion of the installation, the air springs should be inspected for proper alignment. Although the air helper springs can function with some misalignment, it is preferred that the air springs be mounted so that they are aligned with as little top to bottom offset as possible.

Check the distance between the upper bracket and lower bracket (design height). The dimensions shown on **Page 5** are a guide to assist in determining the ideal operating height for your air helper springs.

INFLATING THE AIR SPRINGS

With the air helper springs installed on your vehicle and the vehicle sitting on a level surface, visually verify that the vehicle is in a level state. If the vehicle is not level (front-to-back or from side-to-side) it can be brought to a level position by inflating the air springs. Each air spring has a separate inflation valve. To level the vehicle from front-to-back, add air pressure to both air springs in equal amounts. To level the vehicle from side-to-side, add more air pressure to the air spring on the lower side of the vehicle. When inflating the air springs, add air pressure in small quantities, checking the pressure frequently. The air spring requires much less air volume than a tire, and therefore, will inflate and deflate quickly.

WARNING: DO NOT EXCEED THE MAXIMUM PRESSURE AS INDICATED IN THE INSTALLATION MANUAL

LEVELING THE VEHICLE

Check the level of your vehicle visually. If it is not level, either from front to back or from side to side, level it by inflating your air springs. (If your vehicle is equipped with a cab control unit or automatic control system refer to the directions for that device.) There is one inflation valve for each air spring. To level from front to back, add air pressure to both air springs equally. For side to side, add air pressure to the air springs on the side of the vehicle that is low. When adding air pressure to the air springs, remember that they have a much smaller volume of air than a tire so they will inflate much quicker. Add air pressure in short bursts until the vehicle is level. (NEVER EXCEED 100psi IN EACH AIR SPRING.)

MAINTENANCE

It is considered normal for air helper springs to lose some air pressure over time. Normal pressure loss should not exceed 3 – 4 psi per week when the air springs are inflated to 50 psi. If the pressure loss is greater than 3 – 4 psi per week, there may be a leak in the system. Each time you check the pressure in the air springs, you will lose 1 – 3 psi. The air pressure should be checked at regular intervals.

It is recommended that the air pressure be checked according to the following guidelines:

At least monthly intervals during the continuous operation of the vehicle (see above)

When the vehicle is removed from long-term storage

If the air springs are used to assist in leveling an RV or camper on uneven ground, ensure that the vehicle is returned to a level ride height before departing.

The brackets used to secure the air helper spring to the vehicle should be inspected periodically for damage and for loose fasteners. Ensure that the air line tubing is clear of any sharp edges and routed away from the exhaust system. The brackets and air line tubing should be inspected every 6 months. Ensure that the threaded fasteners are torqued to the specifications listed on **Page 3**.

Accumulated sand, gravel, or other road debris on the air springs or brackets should be rinsed away with a garden hose each time the vehicle is washed.

If it is necessary to lift the vehicle by the frame, first release the air pressure from the air springs. This will allow the air springs to extend to their maximum length without being damaged. The uninflated air springs are capable of supporting the weight of the axle when the vehicle is lifted by the frame. After servicing of the vehicle is complete, lower the vehicle to the ground and reinflate the air helper springs to the desired pressure. **NOTE:** On Sport-Rite kits the air helper springs must be aired up to 50 psi and then release the air until the air helper springs are to the desired pressure.

ONLINE AUCTION PURCHASES

Firestone will not replace missing components from any kit purchased through an online auction.

AIR SPRING TECHNICAL DATA

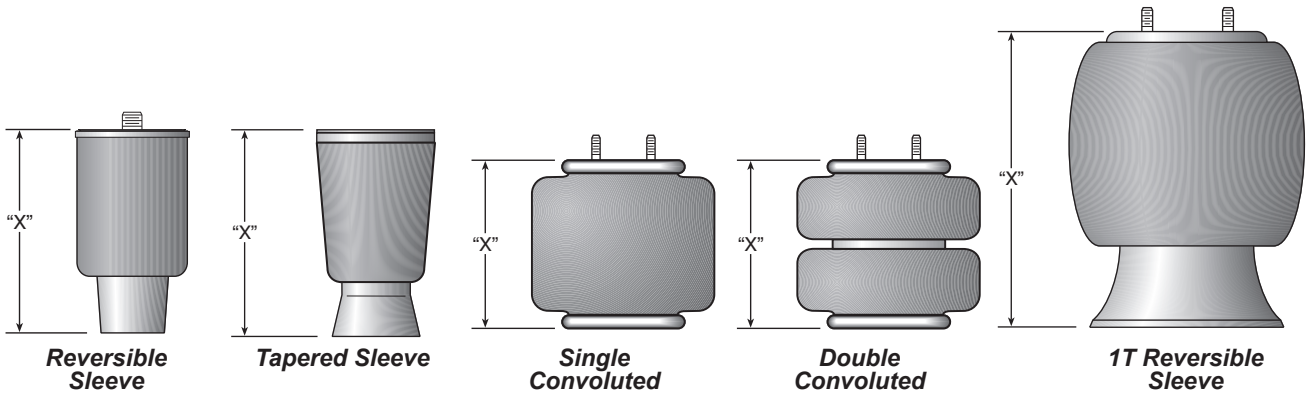

Part Number	Description	Style	"X" Ride Height	Min/Max Air Pressure	Max Load @100 psi (per pair)
6868	Single Convoluted	160BY	5.0" - 6.0"	5 / 100 psi	3600 lbs
6762 6764 6766	Double Convoluted	268C	4.5" - 5.5"	5 / 100 psi	3200 lbs
6397 6410 6781	Double Convoluted	267C1.5	5.5" - 6.5"	5 / 100 psi	4800 lbs
6401 6873 6859	Double Convoluted	224C	5.5" - 7.0"	5 / 100 psi	5000 lbs
7689 7701	Double Convoluted	26C	7.0" - 8.0"	5 / 100 psi	5640 lbs
7076	Reversible Sleeve	70mm	6.0" x 8.0"	10 / 100 psi	2000 lbs
9000	Tapered Sleeve	110/70 mm	7.75" - 8.75"	10 / 100 psi	3000 lbs
9001	Tapered Sleeve	110/70 mm	5.88" - 6.88"	10 / 100 psi	3000 lbs
9002	Tapered Sleeve	110/70 mm	6.75" - 7.75"	10 / 100 psi	3000 lbs
5405	1T Reversible Sleeve	1T14C-3	8.0" - 12.0"	5 / 100 psi	6400 lbs

This information is provided for reference purposes only. The bracketry and air springs in the Ride-Rite™ and Sport-Rite™ kits are designed to work with the original suspension and within the manufacture's Gross Vehicle Weight Rating (GVWR) for the intended vehicle. Brackets and air springs should not be interchanged or modified.

Air Command™ Air Control Systems

Firestone has expanded the offering of Air-Rite™ Air Control Systems, which provides an instant air source for air suspension products. Adjust the ride for various load and road conditions with a flip of a switch or even a click on a remote. Individual air accessory components are also available, including compressors, air tanks and mounting solutions, providing a wide variety of air control assist solutions.

- Step 1** Choose the application you need; Single or Dual Leveling. >>
- Step 2** Choose the style you want to control your air; Analog or Wireless. >>
- Step 3** Choose the Duty Cycle needed for your kit/vehicle. Recommended duty cycle is listed in the Application Guide. >>>

Light Duty	<ul style="list-style-type: none"> • 1-Year Warranty • Includes 9377 Compressor • Best for passenger cars, SUVs, vans, small pickups for occasional use and light loads 	
Standard Duty	<ul style="list-style-type: none"> • 1-Year Warranty • Includes 9284 Compressor • Best for moderate usage, including towing boats, trailers 20' or smaller and medium loads 	
Heavy Duty	<ul style="list-style-type: none"> • 2-Year Warranty • Includes 9499 Compressor • Best for 8-lug trucks, trailers larger than 20', slide-in campers and heavy loads 	
Xtra	<ul style="list-style-type: none"> • 2-Year Warranty • Includes 9499 Compressor • Includes Half-Gallon Air Tank • Includes 9006 Air Hose • Best usage same as Heavy Duty, plus motorcycle tire, golf cart tire or trailer tire inflation 	  
Xtreme	<ul style="list-style-type: none"> • 2-Year Warranty • Includes 9287 Compressor • Includes 2-Gallon Air Tank • Includes 2311 Air Hose • Best usage same as Heavy Duty, plus off-road tire or truck tire inflation 	  

Single Leveling System

Equal pressure to the springs on both sides. This applies to most towables using a hitch.



Analog

2538

Mounting Plate: **2497**

2158

Mounting Plate: **2497**

2097

Mounting Plate: **2497**

2266

Mounting Plate: **2530**

2543

Mounting Plate: **2530**

Dual Leveling System

Allows for side-to-side or front-to-back leveling. This applies to work trucks, in-bed campers and off-center loads.



Analog



Wireless

N/A

2581

Mounting Plate: **2588**

2178

Mounting Plate: **2497**

2589

Mounting Plate: **2588**

2219

Mounting Plate: **2497**

2590

Mounting Plate: **2588**

2168

Mounting Plate: **2530**

2591

Mounting Plates: **2588/2496**

2549

Mounting Plate: **2530**

2592

Mounting Plates: **2588/2496**

TROUBLE SHOOTING GUIDE

Air spring will not inflate

Ensure that the air line tubing is inserted into the air fittings as far as possible. The tubing should go in the fitting 3/4 of an inch. You will feel some resistance when the tubing goes past the o-ring.

Clear any dirt or debris from inside the inflation valves.

Inspect the entire length of air line tubing to ensure that it is not kinked, damaged from exhaust heat, or cut due to contact with sharp edges

Air spring will not hold air

Normal pressure loss is no more than 3 - 4 psi per week when the air spring is inflated to 50 psi.

Using the inflation valve cap as a core tool, ensure that the valve stem core is installed securely.

Apply a solution of soap and water to the air fittings, air line, and air springs to check for leaks. Tighten the air fitting or re-install the tubing in the air fitting to stop the leak. Rinse the soap and water solution from the system when complete.

If a leak can not be detected with the soap and water solution, deflate the air springs and remove them from the vehicle. Re-install the tubing and inflation valve on the air spring and inflate the air spring to a maximum of 20 psi. Submerge the air spring in a bucket of water to check for leaks.

Locations of air leaks

Leaks occur most often at the threaded connection between the air fittings and the air springs. Tighten the fitting to engage the pre-applied orange thread sealant or until the nylon collar makes contact with the air spring, plus 1/2 turn, depending on which type of fitting is included in your kit. (See air fittings on page 3)

The end of the air line tubing must be cut square and clean to avoid burrs in the connection to the air fittings. The push-to-connect fittings require a square cut to properly seal. The tubing can be removed from the fitting by first releasing the air pressure from the air spring. Push the collar on the fitting toward the body of the fitting. While holding the collar in, pull out the tubing. Cut the tubing squarely and push the tubing into the fitting as far as possible.

The vehicle is not level

Check for proper inflation of the air springs on each side of the vehicle.

Check for obstructions in the air system or vehicle components that may be restricting suspension travel.

IMPORTANT

NYLON TUBE CUTTING:
FOLLOW THESE INSTRUCTIONS
TO AVOID LEAKS

