



## Ventvisor® Deflector

For proper installation and best possible fit, please read all instructions BEFORE you begin.  
For technical assistance or to obtain missing parts, please call Customer Relations at 1-800-344-8759.

### Important Safety Information



- CAUTION - Before driving, ensure that the vent visor is properly secured to vehicle.
- Do not use automatic "brush-style" car washes.
- Do not use cleaning solvents of any kind.
- Periodically check all components for tightness.

### Contents - 4 Piece Set

**NOTE:** Actual product may vary from illustration.

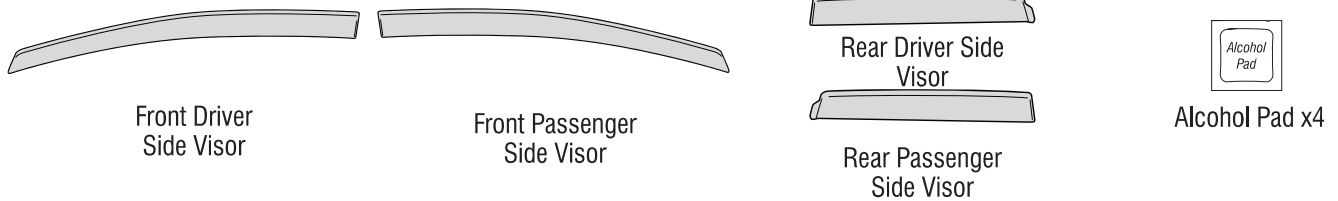

### Contents - 6 Piece Set

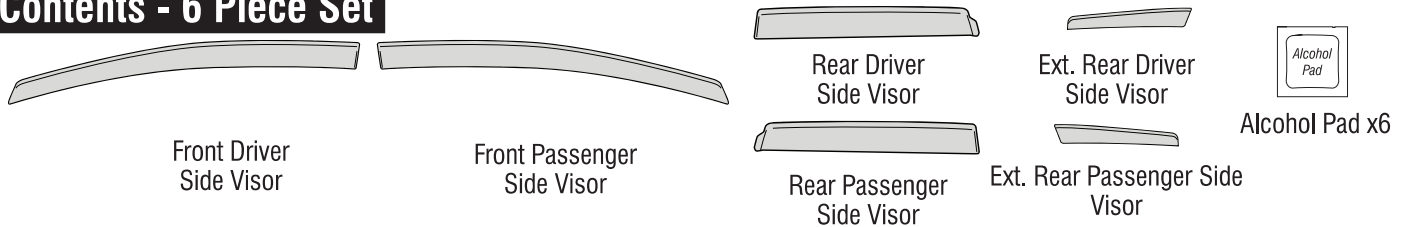

### Tools Required



### Preparation Before Painting / Installation

- A trial fit is recommended to ensure proper positioning and fit.
- Check fit of parts before painting as we will not accept the return of modified or painted parts.
- Wash and dry your vehicle to remove any debris and/or dirt from the installation area.

### Installation Steps

**NOTE:** Actual application may vary slightly from illustrations.

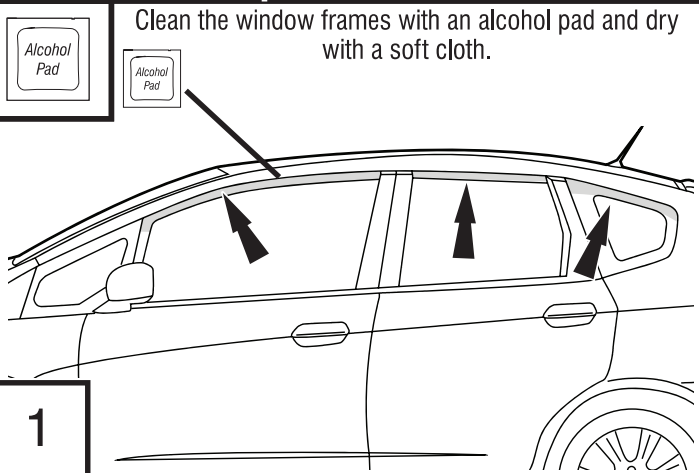

Peel back 2" (5cm) of tape liner from rear end of top flange. Ensure free end is accessible. Remove tape liner from front flange and small tab.

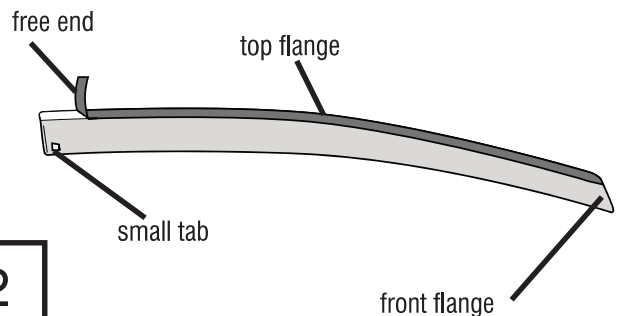

# Installation Steps

**NOTE:** Actual application may vary slightly from illustrations.

Align the Front Visor on the outside of the door frame.

3

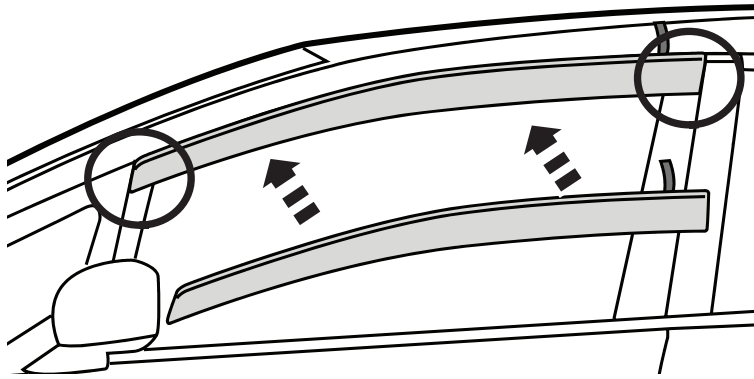

Gently press the exposed areas of tape against the surface and verify position. With the Front Visor in its final position, remove the remaining tape liner by pulling on free end.

4

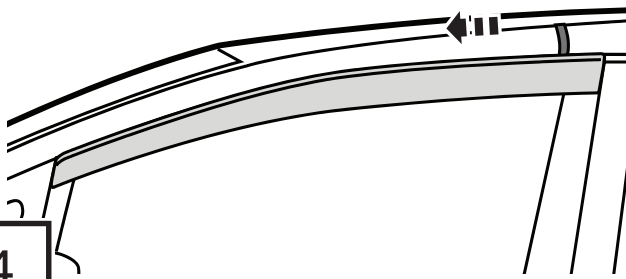

Apply pressure along all flanges to ensure proper adhesion of tape.



5

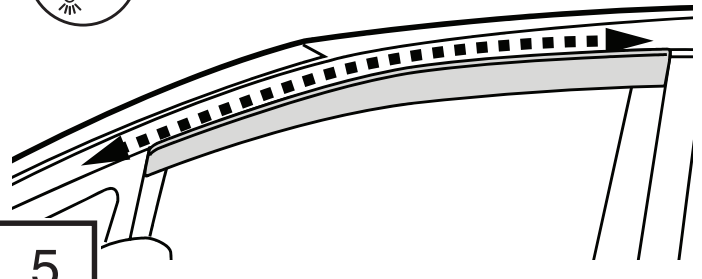

## 4 Piece Set

Peel back 2" (5 cm) of tape liner from each end of top flange. Completely remove small tab tape liner.

6

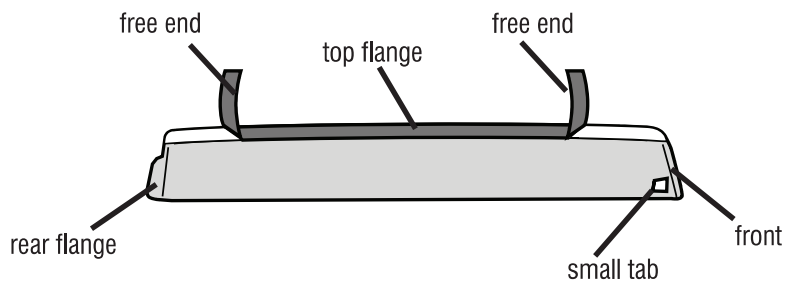

Align the front edge of the visor with the front of the rear door, and slide the rear visor flange **BETWEEN** the plastic applique and rubber weatherstrip at the rear location. Align the top of the visor with the top of the door frame.

7

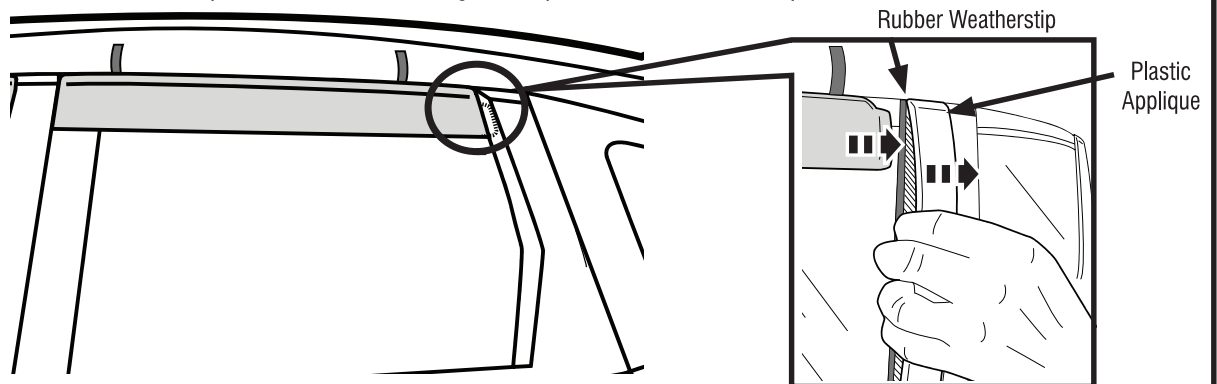

## Installation Steps **NOTE:** Actual application may vary slightly from illustrations.

Gently press the exposed areas of tape against the surface and verify position. With the Rear Visor in its final position, remove the remaining tape liner by pulling on free ends.

8

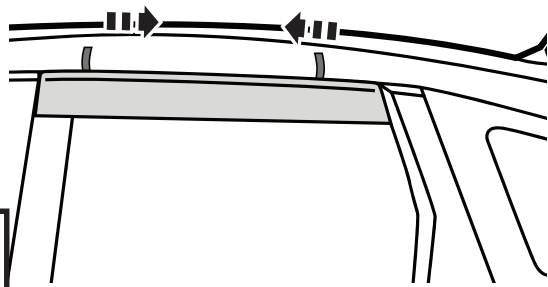

Apply pressure along all flanges to ensure proper adhesion of tape.

9

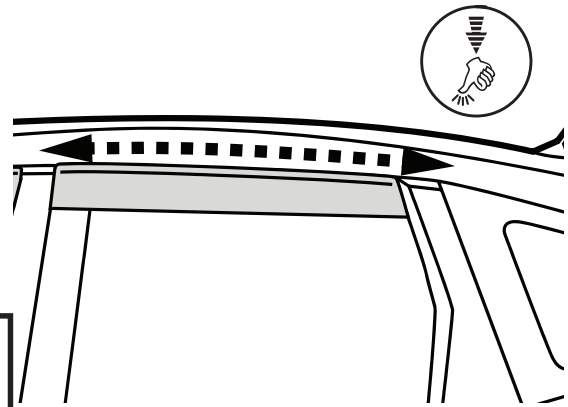

### 6 Piece Set

Remove tape liner from front and rear flanges of Extended Rear Visor. Peel back 2" (5cm) of tape liner from end of top flange.

10

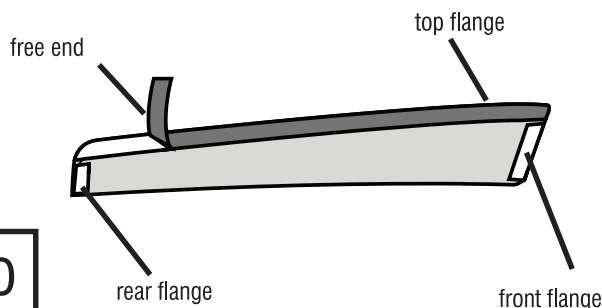

Align the deflector on the outside of the door frame. Align the front of the Extended rear Visor parallel to the previously installed Rear Visor.

11

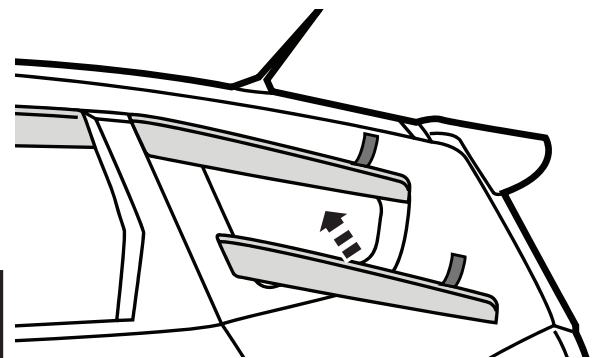

Gently press the exposed areas of tape against the surface and verify position. With the visor in its final position, remove the remaining tape liner by pulling on free ends.

12

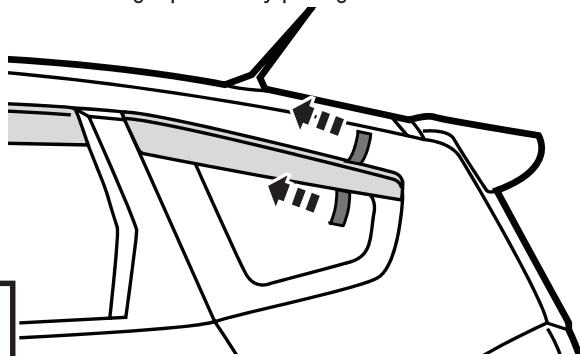

Apply pressure along all flanges to ensure proper adhesion of tape.

13

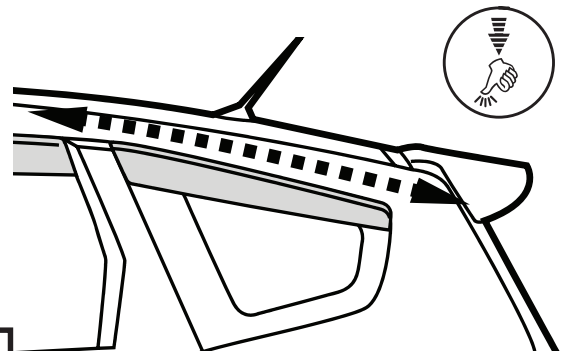

Repeat **Steps 1 - 13** for opposite side.

### Care and Cleaning

- Wash only with mild soap & dry with a clean cloth.



The material that your product is made from can be recycled. Please also consider recycling the packaging that your product came in.



### Congratulations!

You have purchased one of the many quality Husky® branded products. We take the utmost pride in our products and want you to enjoy years of satisfaction from your investment. We have made every effort to ensure that your product is top quality in terms of fit, durability, finish and ease of installation.



1-800-344-8759 • Visit us at [huskyliners.com](http://huskyliners.com)

© 2023 Husky Liners, Inc. All rights reserved.

Husky® and the Husky® logo are trademarks of Husky Liners, Inc.