



Ventvisor® Deflector

**For proper installation and best possible fit, please read all instructions BEFORE you begin.
For technical assistance or to obtain missing parts, please call Customer Relations at 1-800-344-8759.**

Important Safety Information



- CAUTION - Before driving, ensure that the vent visor is properly secured to vehicle.
- Do not use automatic "brush-style" car washes.
- Do not use cleaning solvents of any kind.
- Periodically check all components for tightness.

Contents - 2 Piece Set **NOTE:** Actual product may vary from illustration.

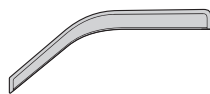

Front Driver Side Visor

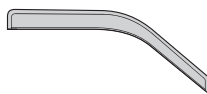

Front Passenger Side Visor

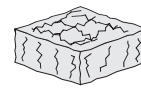

Scotch Brite Pad



Alcohol Pad x2

Contents - 4 Piece Set

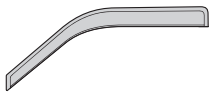

Front Driver Side Visor

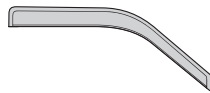

Front Passenger Side Visor



Rear Driver Side Visor



Rear Passenger Side Visor

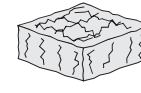

Scotch Brite Pad



Alcohol Pad x4

Tools Required



Car Wash Supplies



Clean Towel

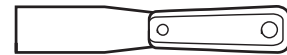

Putty Knife

Preparation Before Painting / Installation

- A trial fit is recommended to ensure proper positioning and fit.
- Check fit of parts before painting as we will not accept the return of modified or painted parts.
- Wash and dry your vehicle to remove any debris and/or dirt from the installation area.

Installation Steps **NOTE:** Actual application may vary slightly from illustrations.



Lower the window & scuff the outside of the rubber window trim where the visor will attach. Clean the scuffed area with an alcohol pad.

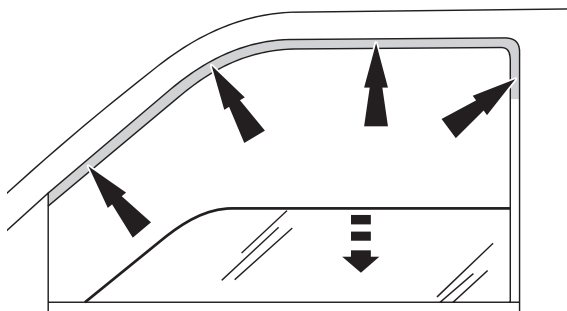

1

Remove the tape liner from the rear flange. Peel back 2" of tape liner from each end of top flange.

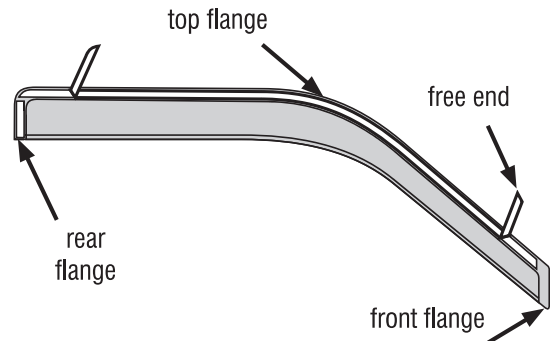

2

Installation Steps

NOTE: Actual application may vary slightly from illustrations.

Slide the front flange behind the mirror cap, use a putty knife to create a gap if needed. Attach the top and rear flanges to the rubber window trim.

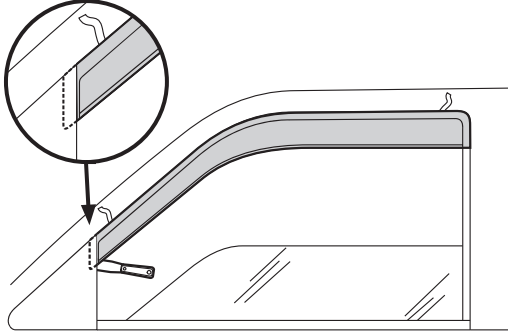

3

Remove tape liner by pulling on free ends. Apply pressure to top and rear tape flanges to secure.

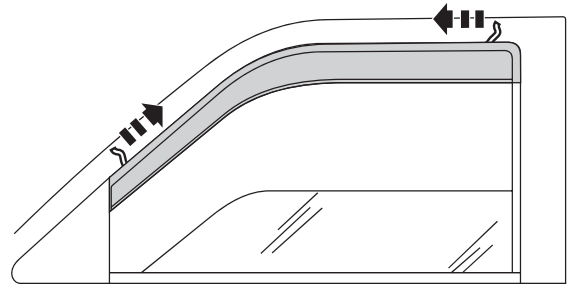

4

4 Piece Set

Clean glass with an alcohol pad. Attach visor to the vehicle's window glass as shown.

Rear visor attached
to glass

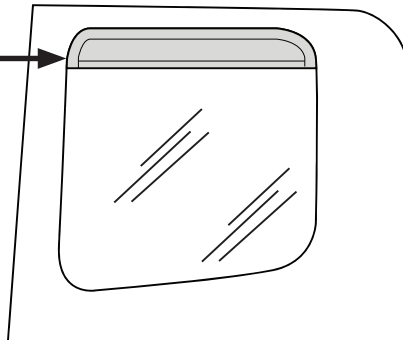

NOTE: Do **NOT** use Scotch Brite pad on window glass

5

Care and Cleaning

- Wash only with mild soap & dry with a clean cloth.



The material that your product is made from can be recycled. Please also consider recycling the packaging that your product came in.



Congratulations!

You have purchased one of the many quality Husky® branded products. We take the utmost pride in our products and want you to enjoy years of satisfaction from your investment. We have made every effort to ensure that your product is top quality in terms of fit, durability, finish and ease of installation.



1-800-344-8759 • Visit us at huskyliners.com

© 2023 Husky Liners, Inc. All rights reserved.

Husky® and the Husky® logo are trademarks of Husky Liners, Inc.