

HUSKY Ventvisor® Deflector

**For proper installation and best possible fit, please read all instructions BEFORE you begin.
For technical assistance or to obtain missing parts, please call Customer Relations at 1-800-344-8759.**

Important Safety Information



- CAUTION - Before driving, ensure that the vent visor is properly secured to vehicle.
- Do not use automatic "brush-style" car washes.
- Do not use cleaning solvents of any kind.
- Periodically check all components for tightness.

Contents - 2 Piece Set **NOTE:** Actual product may vary from illustration.

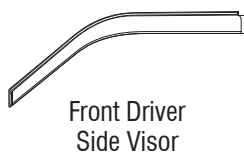

Front Driver Side Visor

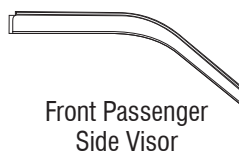

Front Passenger Side Visor

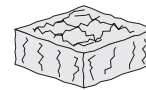

Scotch Brite Pad



Alcohol Pad x2

Contents - 4 Piece Set

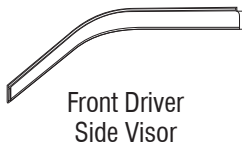

Front Driver Side Visor

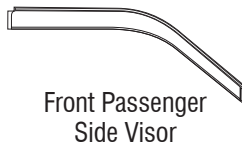

Front Passenger Side Visor



Rear Driver Side Visor



Rear Passenger Side Visor



Scotch Brite Pad



Alcohol Pad x4

Tools Required



Car Wash Supplies



Clean Towel

Preparation Before Painting / Installation

- A trial fit is recommended to ensure proper positioning and fit.
- Check fit of parts before painting as we will not accept the return of modified or painted parts.
- Wash and dry your vehicle to remove any debris and/or dirt from the installation area.

Installation Steps **NOTE:** Actual application may vary slightly from illustrations.



Roll down window. Buff the inside felt surface with scotch brite pad. Then clean with alcohol pad.

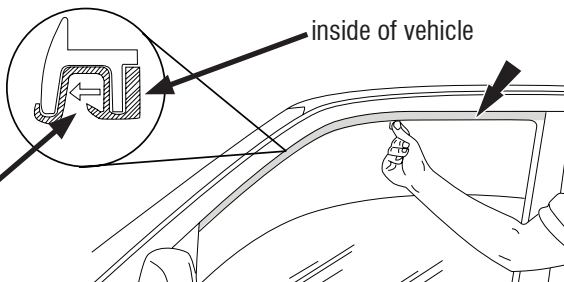

clean

inside of vehicle

1

NOTE: visors mount on the **inside** of the window channel.

Remove tape liner from front flange. Peel back 2" of tape liner from each end of top flange.

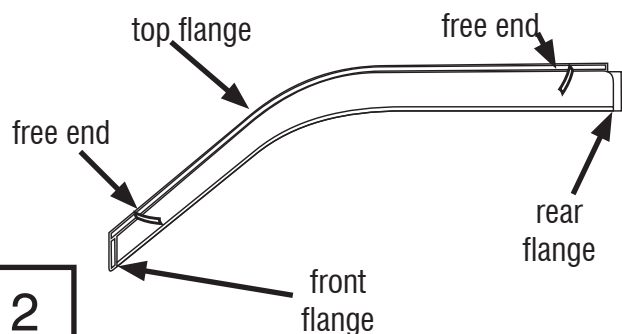

free end

top flange

free end

rear flange

front flange

2

Installation Steps

NOTE: Actual application may vary slightly from illustrations.

Insert visor rear flange first. Rear flange inserts between the trim and the exterior surface. The front & top flange slides into the window channel.

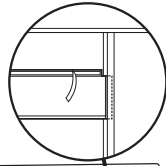

3

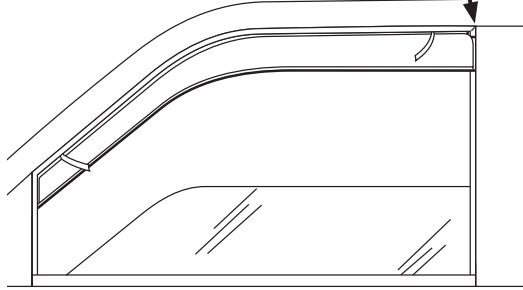

Apply pressure to all flange edges to ensure proper adhesion. Remove tape liner by pulling on free ends.

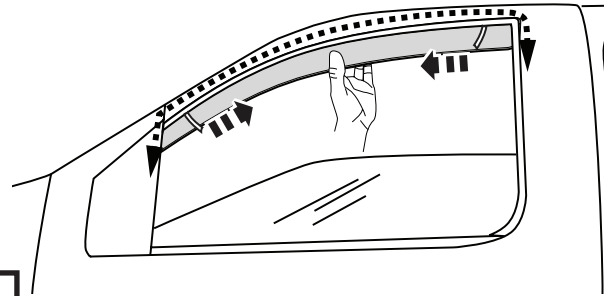

4

NOTE: It is necessary to both hold the visor up into the window channel **AND** pull the bottom of the visor slightly outward while raising the glass to seat visor properly.

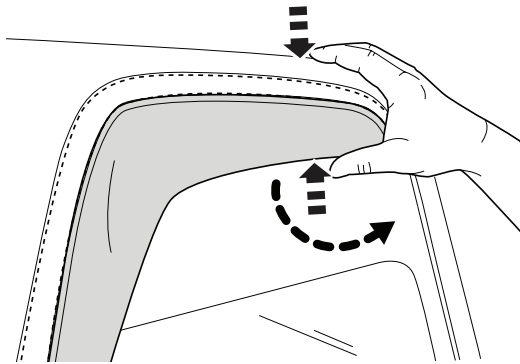

5

Continue to apply pressure to ensure that the visor remains properly seated inside the window channel as window is slowly closed. Leave window up for 72 hours to secure visor to window channel.

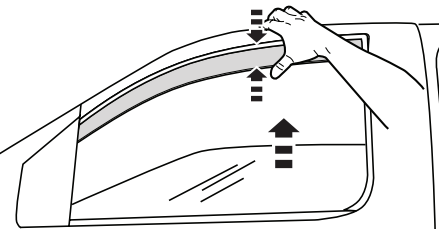
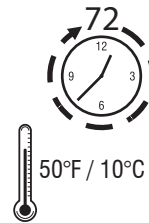

6

If the visor does not seat correctly, roll down window and repeat **Step 5**.

4 Piece Set

Install the rear visor using the same preparation and installation methods as front visor. Note that the top & rear flanges slide into the window channel, and the front flange fits between the rubber & window frame.

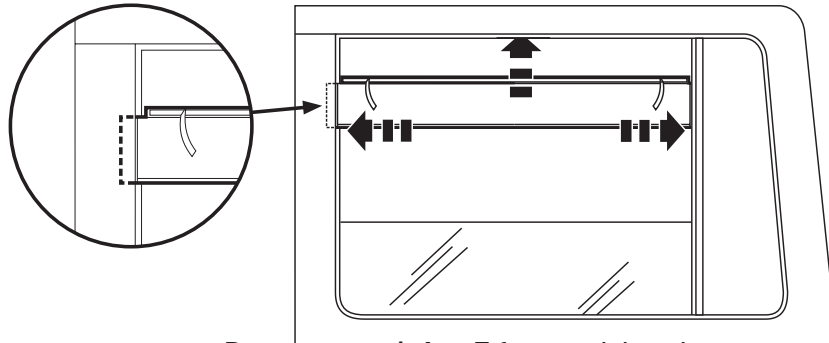

7

Repeat **steps 1 thru 7** for remaining visors

Care and Cleaning

- Wash only with mild soap & dry with a clean cloth.

Congratulations!

You have purchased one of the many quality Husky® branded products. We take the utmost pride in our products and want you to enjoy years of satisfaction from your investment. We have made every effort to ensure that your product is top quality in terms of fit, durability, finish and ease of installation.

HUSKY®

1-800-344-8759 • Visit us at huskyliners.com

© 2023 Husky Liners, Inc. All rights reserved.

Husky® and the Husky® logo are trademarks of Husky Liners, Inc.