

RUGGED COVER

Premium Vinyl Tri-Fold Cover Installation Instructions

200 Universal Dr. • Owosso, MI 48867 • 989-725-8354 • Fax: 989-725-8409 • 1-800-433-3604



1

1. Place the cover on front of truck bed.



Place dust seal between cab and truck bed.



7

7. Cover is laying down flat.

8. Secure rear clamps for a tight fit.

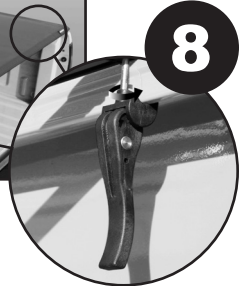

8



2

2. Secure cab clamp hooks under the metal bed rail. Toyota Models Only - Tighten lock nut at bottom of knob.



9. Vehicles With Utility Track

- All Toyota Tacoma or Tundra Pickups.
- 2007 GMC/Chevy Pickups
- 2008 Ford Pickups
- 2008 Nissan Pickups
- 2008 Dodge Pickups

Use aluminum block to attach cover by sliding into place and locking clamping on to blocks. *(See Back For Details)*

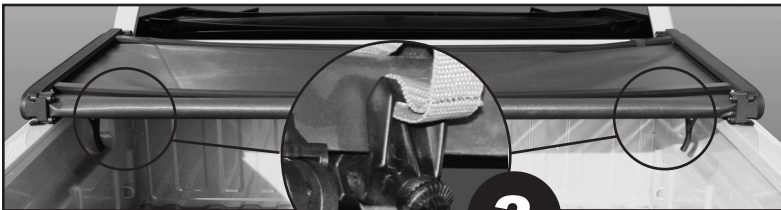

3

3. Attach safety tether strap on both sides.



4

4. Undo both clips so cover can be unfolded.

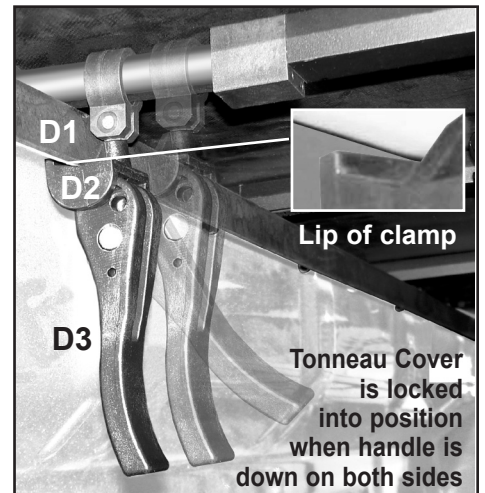
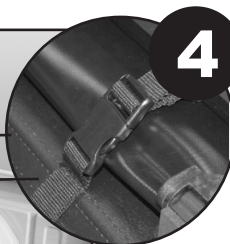

2&7. To clamp cover down, put lip of clamp under side bed rail and push handle down. *(See D1, D2, D3)*

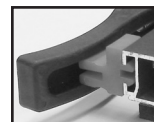

Use orange clip to store clamp when cover is folded.



5

5. Unfold first section.

6

6. Unfold second section.

How To Adjust Clamps

- The clamps might need adjusted.
- To adjust, turn handle on clamp clockwise to tighten or counter clockwise to loosen.

Patent No's.
7,823,957 /
8,146,982 /
8,256,824



www.ruggedliner.com

9

GM Pickups with Utility Track

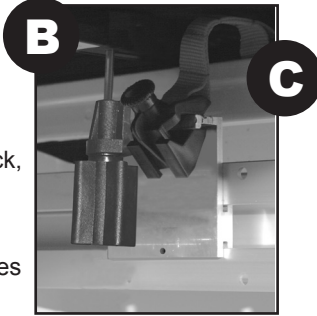
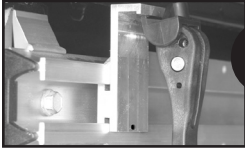
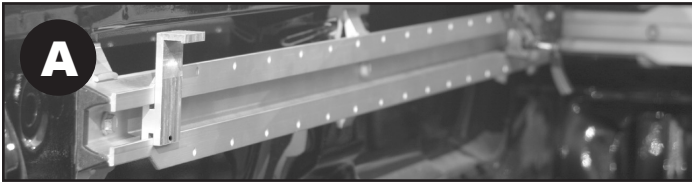

- A.** Slide aluminum blocks into track, position and tighten set-screw.
- B.** Secure front clamp on to aluminum block.
- C.** Attach safety strap on both sides to aluminum block.
- D.** Attach rear clamps

9

Nissan Pickups with Utility Track

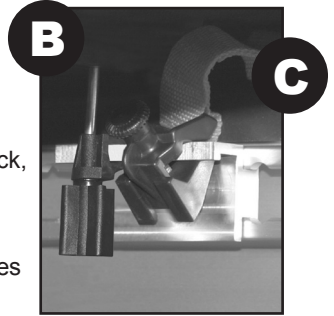
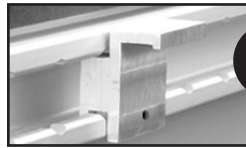

- A.** Slide aluminum blocks into track, position and tighten set-screw.
- B.** Secure front clamp on to aluminum block.
- C.** Attach safety strap on both sides to aluminum block.
- D.** Attach rear clamps

9

Dodge Pickups with Utility Track

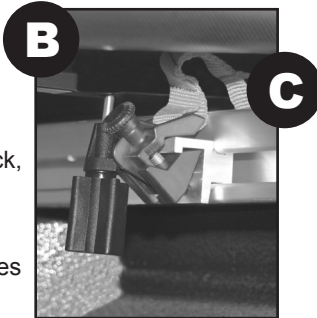
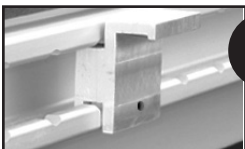

- A.** Slide aluminum blocks into track, position and tighten set-screw.
- B.** Secure front clamp on to aluminum block.
- C.** Attach safety strap on both sides to aluminum block.
- D.** Attach rear clamps

9

Toyota Pickups with Utility Track

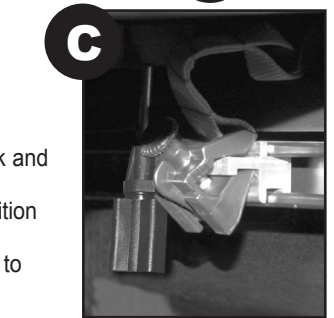
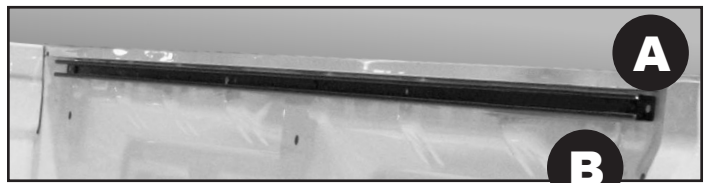

- A.** Loosen rear 2 bolt's on utility track and slide aluminum blocks into track.
- B.** Re-tighten rear 2 bolt's. Then position and tighten blocks with set-screw.
- C.** Secure front clamp & safety strap to aluminum block on both sides.
- D.** Attach rear clamps.

9

Ford Pickups with Utility Track

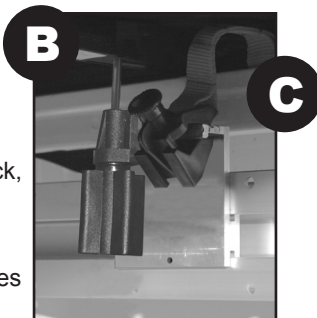
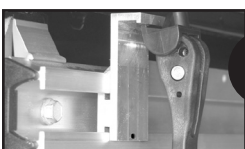
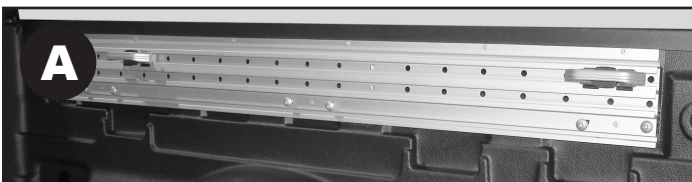

- A.** Slide aluminum blocks into track, position and tighten set-screw.
- B.** Secure front clamp on to aluminum block.
- C.** Attach safety strap on both sides to aluminum block.
- D.** Attach rear clamps

10

Useful Information.

- A.** If there is a gap from the corner to the edge of the wing tailgate piece when the cover is fastened. (1) You can put an extra foam corner piece on the back existing corner pieces. (2) Take the roll of foam and measure from the edge of the tailgate piece to the edge of the corner piece on both sides, cut and stick to existing foam.
- B.** Or, Replace the Wing Style Tailgate Piece with a Flatter Style Tailgate Piece.

