



SUPERLIFT
SUSPENSION

300 HUEY LENARD LOOP | WEST MONROE | LA 71292
OFFICE: 318-397-3000 | FAX: 318-397-3040
SERVICE & TECH SUPPORT: 800-551-4955
SUPERLIFT.COM

2019-2023 GM 1500 PICKUP 4WD 3" UCA Lift Kit INSTALLATION INSTRUCTIONS





MAKE SURE YOU HAVE THE CORRECT LIFT FOR YOUR VEHICLE:

Double check the Year, Make, Model, Lift Height and KIT Part Numbers.

Prior to beginning the installation, OPEN the Boxes and CHECK the Included Components Compared to the Parts Breakdown. Check all parts and hardware in the box with the parts list below. Be sure you have all needed parts and know where they install.

If you find a packaging error, contact SUPERLIFT directly. Do not contact the dealer where the system was originally purchased. You will need the control number from each box when calling; this number is located at the bottom of the part number label and to the right of the bar code.

How to Read the Kit Breakdown Charts:

The 'KIT BREAKDOWN' lists part numbers, quantities & part description of the individual components & hardware bags that are included in each box.

KIT BREAKDOWN		
Kit Part Number	3610	
Part Number	Qty.	Description
55-01-3610	1	Upper Control Arm, Driver Side
55-02-3610	1	Upper Control Arm, Passenger Side
55-10-3610	2	Strut Spacer, 1-1/16"
55-11-3610	2	Preload Spacer
55-07-3610	2	Steel Preload Spacer
55-22-3610	2	Sway Bar Bracket
019	2	Rear Blocks, 1.5"
10422	4	9/16" x 2.5" x 8.5" Ubolts, Square Bend
77-3610	1	Hardware Bag, Kit
77-1509	1	Hardware Bag, Hi-Nut & Ubolt Flat Washers
77-80033	1	Hardware Bag, Shocks
659583	2	SUPERLIFT Shock Cylinder, Rear

THANK YOU FOR CHOOSING SUPERLIFT FOR ALL YOUR SUSPENSION NEEDS!!

INTRODUCTION BEFORE INSTALLATION...

Installation requires a professional mechanic. In addition to these instructions, professional knowledge of disassembly / reassembly procedures and post installation checks must be known.

PRIOR to beginning, inspect the vehicles steering, driveline, and brake systems, paying close attention to the suspension link arms and bushings, sway bars and bushings, tie rod ends, pitman arm, idler arm, ball joints and wheel bearings. Also check the steering sector-to-frame and all suspension-to-frame attaching points for stress cracks. The overall vehicle must be in excellent working condition; repair or replace all worn parts.

Read instructions several times before starting. Read each step completely as you go.

Be sure you have all needed parts and know where they install.

- **The upper control arm ball joints DO NOT have grease installed. They MUST be greased prior to driving.**
- Front end alignment is necessary.
- A foot-pound torque reading is given in parenthesis () after each appropriate fastener.
- Tool and Wrench/Socket size is given in brackets [] after each appropriate step.
- Always wear safety glasses when using power tools.
- Prior to attaching components, be sure all mating surfaces are free of grit, grease, excessive undercoating, etc.
- Do not fabricate any components to gain additional suspension height.
- A factory service manual should be on hand for reference.
- Due to payload options and initial ride height variances, the amount of lift is a 'base figure'. Final ride height dimensions may vary in accordance to original vehicle stance.

BEFORE YOU DRIVE...

Check all fasteners for proper torque. Check to ensure for adequate clearance between all rotating, mobile, fixed, and heated members. Verify clearance between exhaust and brake lines, fuel lines, fuel tank, floor boards and wiring harness. Check steering components for clearance.

Test and inspect brake system. Perform steering sweep to ensure front brake hoses have adequate slack and do not contact any rotating, mobile or heated members. Inspect rear brake hoses at full extension for adequate slack. Failure to perform hose check/replacement may result in component failure.

It is ultimately the buyer's responsibility to have all bolts / nuts checked for tightness after the first 100 miles and then every 1000 miles. The steering, suspension and driveline systems, plus wheel alignment should be inspected by a qualified professional mechanic at least every 3000 miles.

TIRES & WHEELS...

Larger rim and tire combinations may increase leverage on suspension, steering, and related components. When selecting combinations larger than OE, consider the additional stress you could be inducing on the OE and related components.

Stock 18", 20" & 22" Wheels Will Fit back on the vehicle once this suspension system is installed.

ANY larger or wider tire & wheel combination other than listed will require vehicle trimming.

The 2019 and newer Chevy Silverado & GMC Sierra have a larger brake caliper that extends or sticks out past the mounting surface of the wheel. Your choice of aftermarket wheels must be specifically for the 2019 & newer gm models. Backspacing is still crucial, but the wheel's design must state it fits these newer brake caliper models.

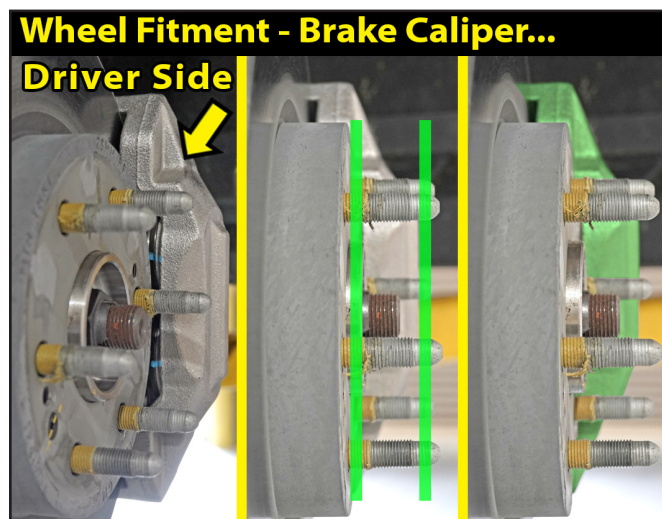

Step	Part Number	Qty. Per Kit	Description	New Attaching Hardware	Qty. Per Bracket	Hardware Bag Number
FRONT						
22	55-01-3610	1	Upper Control Arm, Driver Side	12mm flange nut, 1.25 pitch	1	77-3610
				55-12-3610 - UCA temporary spacer	1	
				1/4" X 3/4" bolt, coarse thread, grade 5	2	
				1/4" nyloc nut, coarse thread	2	
				1/4" SAE washer	4	
22	55-02-3610	1	Upper Control Arm, Passenger Side	12mm flange nut, 1.25 pitch	1	77-3610
				55-12-3610 - UCA temporary spacer	1	
				1/4" X 3/4" bolt, coarse thread, grade 5	2	
				1/4" nyloc nut, coarse thread	2	
				1/4" SAE washer	4	
33	55-07-3610	2	Steel Preload Spacer			
34	55-11-3610	2	Preload Spacer			
39	55-10-3610	2	Strut Spacer	10mm x 70mm bolt, 1.5 pitch	3	77-3610
				10mm Flat Washer	3	
56	55-22-3610	2	Sway Bar Bracket	3/8" x 1-1/4" bolt, coarse thread	2	77-3610A
				3/8" SAE washer	2	
				3/8" nyloc nut, coarse thread	2	
REAR						
9	019	2	Rear Blocks, 1.5"	10422 - 9/16" x 2.5" x 8" ubolt, square bend	2	77-1509
				9/16" hi-nut, fine thread	4	
				9/16" u-bolt washer	4	
11	659583	2	SUPERLIFT Shock Cylinder, Rear	01-60418, hourglass bushing	2	77-80033
				39-3480, 0.75" OD x 0.5630" ID x 1.68" L, sleeve	2	
				3/4" SAE washer	2	



FRONT INSTALLATION

Save all factory components and hardware for reuse, unless noted.

- To properly support the 2019 and up Silverado 1500 & Sierra 1500 trucks, wider lift pad adapters are required because the frame is wider than the previous trucks in the area where the front hoist arm lift pads need to be positioned.
- Chock rear tires and place transmission in neutral. Raise front of vehicle with a jack and secure a jack stand beneath each frame rail. Ease the frame down onto the stands and place transmission in park.
- Raise the hood and disconnect the battery. [10mm]
- Remove front tires and wheels. [22mm]
- [Illustration 1] On each side, disconnect the sway bar link from the lower control arm. [18mm]
- [Illustration 2] Loosen the nut from the tie rod end, then using a tie rod puller, separate the tie rod from the knuckle. Remove the tie rod nut and save for reinstall. [21mm]



- [Illustration 3-A] Above the tie rod boss on the knuckle, remove the ABS line from the knuckle. [10mm]
- [Illustration 3-B] Follow the ABS line up the front of the knuckle and remove the ABS line bracket from the knuckle. [10mm]
- [Illustration 3-C] On the rear side of the knuckle, unplug the brake pad wear sensor from the brake caliper. Follow the ABS line up and remove the brake sensor bracket from the knuckle. [10mm]
- [Illustration 3-D] Unbolt the brake line bracket from the rear side of the knuckle. [10mm]

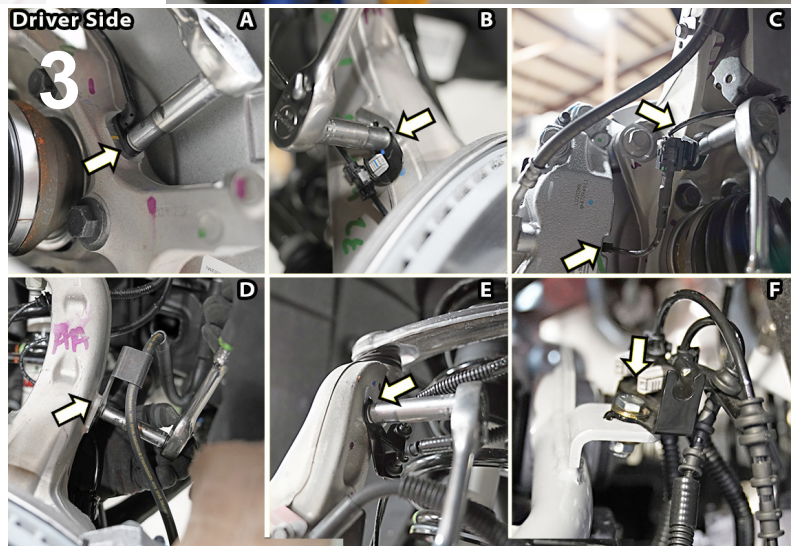

- [Illustration 3-E] Unbolt the ABS line bracket from the inward side of the knuckle. [10mm]
- [Illustration 3-F] Unbolt the ABS line bracket from the upper control arm. [10mm]
- Using a jack, slightly lift the lower control arm (LCA) and knuckle assembly to prevent the arms from being at full droop.

- [Illustrations 4] Remove the nut from the upper ball joint (UBJ), then using the appropriate puller tool, disconnect the ball joints from the knuckle. [18mm] NOTE: Careful not to let the CV axle shaft dislodge from the CV cup or pull out at the differential. Do not let the knuckle fall to the side abruptly, it could cause damage to the ABS wires or brake lines.



15. Lower the jack to allow the removal of the knuckle assembly from the UBJ. Lean the knuckle outward and to the rear to allow access to the strut. Secure the knuckle to the frame with a bungee strap to prevent movement.
16. Mark the alignment of the upper strut mount, upper isolator, and spring seat, also note driver and passenger sides.
17. [Illustration 5-A] Remove the two bolts securing the strut to the lower control arm and allow the lower control arm to hang, while you move to the upper strut mount. [15mm]
18. [Illustration 5-B] Unclip the wire clips located on the top of the studs. [plastic fastener removal tool]
19. [Illustration 5-C] Remove three nuts securing the strut to the frame then remove the strut. [18mm]
20. [Illustration 5-D] Remove the strut from the vehicle.

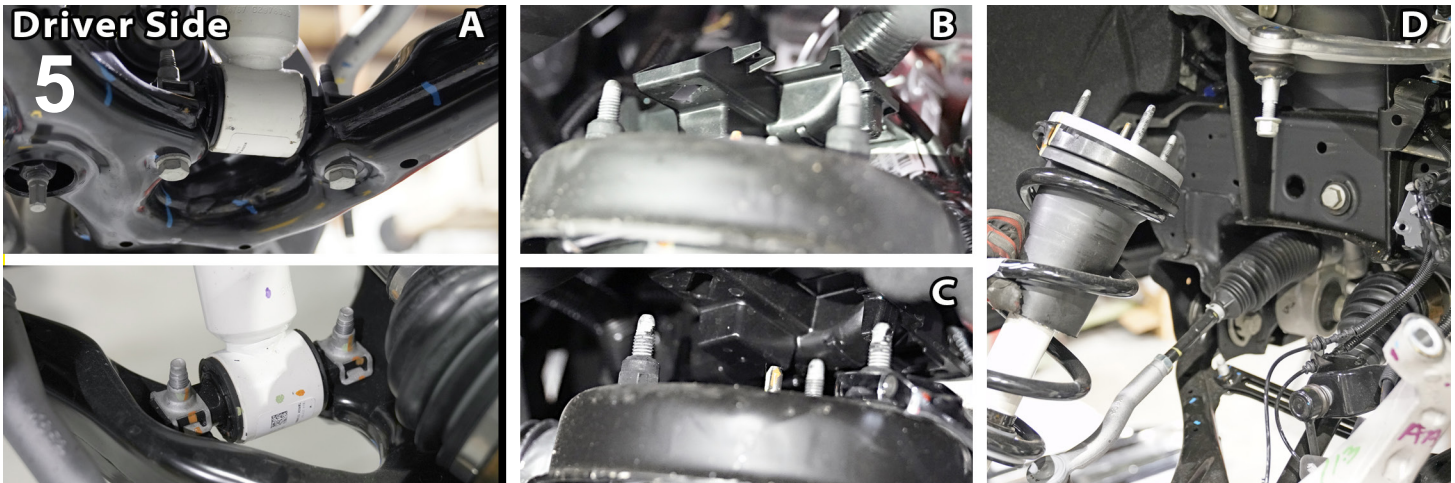

21. [Illustration 6] With the lower control arm still supported with a jack, remove the upper control bolts and remove the upper control arm from the vehicle. [21mm]



22. [Illustration 7-A] Using the factory hardware, install the new Superlift upper control arm (55-01-3610 driver, 55-02-3610 passenger), do not tighten.
23. [Illustration 7-B] Insert the supplied UCA temporary spacer (55-12-3610) in between the factory bump stop bracket and the rear leg of the upper control arm. Roll the upper control arm downward until it rests firmly on the spacer.
24. [Illustration 7-C] Tighten the upper control arm into position, then remove the UCA temporary spacer. [21mm]
25. [Illustration 7-D] Note that the new Superlift UCAs MUST be greased BEFORE vehicle is driven. Failure to add grease to the UCA ball joint will void the warranty.

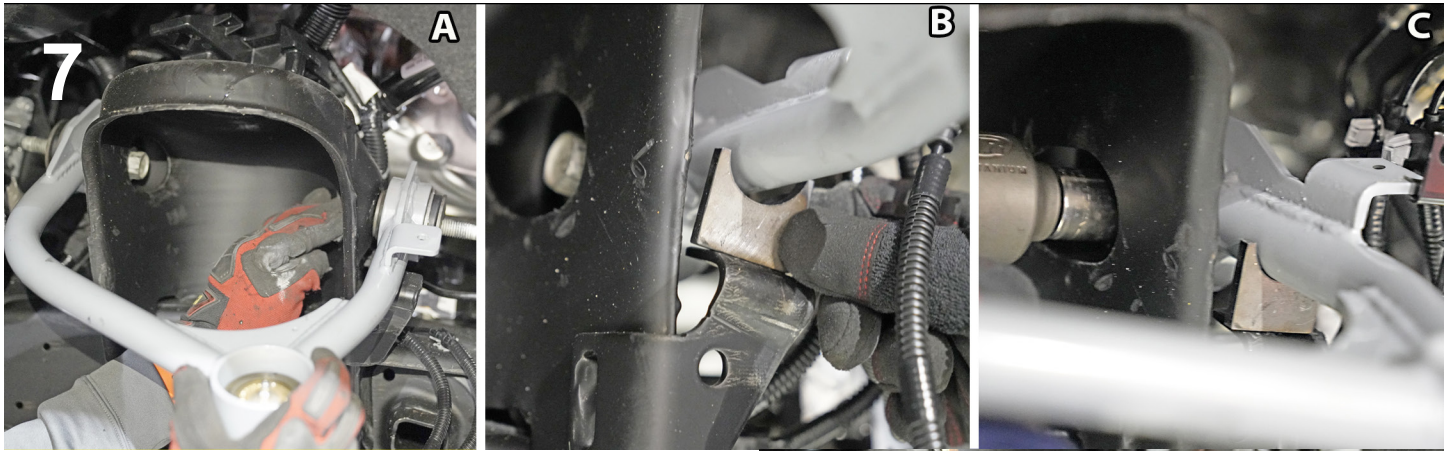

26. Using a suitable coil spring compressor, compress the coil spring until the strut body has approximately 3/8" of free movement. The coil is under extreme pressure and severe bodily injury may occur if the coil spring is disassembled without using a suitable coil spring compressor.

27. [Illustration 8-A] Remove the upper strut mounting plate retaining nut and the strut's upper mounting plate assembly. [6mm, 18mm]

28. Carefully remove the strut cylinder from the coil spring. Inspect the strut assembly for any damage or fluid leakage and replace if necessary.

29. [Illustration 8-B] Separate the rubber coil spring seat and dust boot from the upper isolator.

30. [Illustration 8-C] Remove the foam factory bump stop from the factory upper strut mount.

31. [Illustration 8-D] Separate the upper isolator from the factory upper strut mount.

32. [Illustration 8-E] Remove the three (3) factory studs out of the factory strut mount.

33. [Illustration 8-F] Place the new steel preload spacer (55-07-3610) on top of the factory upper isolator. Align the two (2) holes in the steel spacer with the two (2) tabs on the factory isolator.

34. [Illustration 8-G] Insert the supplied 10mm x 70mm bolts upward through the factory upper strut mount. Place the new preload spacer (55-11-3610) under the factory strut mount assembly aligning the machined slots with the bolt heads, then place the preload spacer on top of the steel pre-load spacer and factory upper isolator.

35. [Illustration 8-H] Reinstall the factory foam bump stop back into the upper strut mount.

36. [Illustration 8-I] Install the factory rubber coil spring seat and dust boot onto the upper isolator. Check your alignment marks to be sure all five (5) components are aligned correctly.

37. [Illustration 8-J] Position the strut cylinder back into the compressed coil spring. Align the indexing marks on the lower strut eye mount and the coil spring.

38. Slowly decompress the coil spring on the strut assembly while ensuring that the coil spring remains seated correctly in its lower seat and that ALL index marks remain aligned.

39. [Illustration 8-K] Tighten the upper strut mounting plate retaining nut and place the new strut spacer (55-10-3610) on top of the strut over the new studs. [6mm, 18mm]

40. [Illustration 8-L] Strut assembly overview.



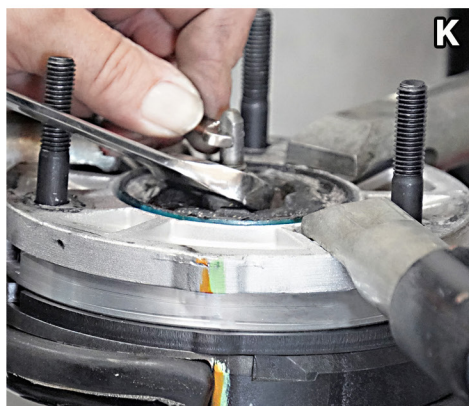
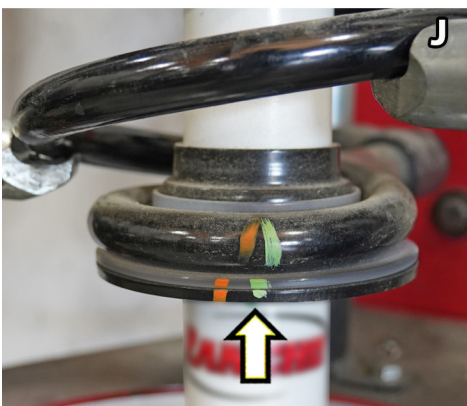
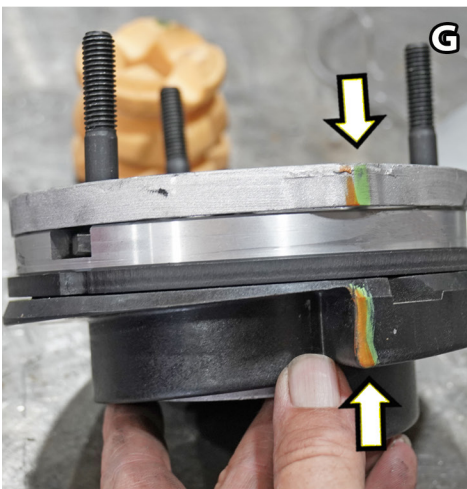
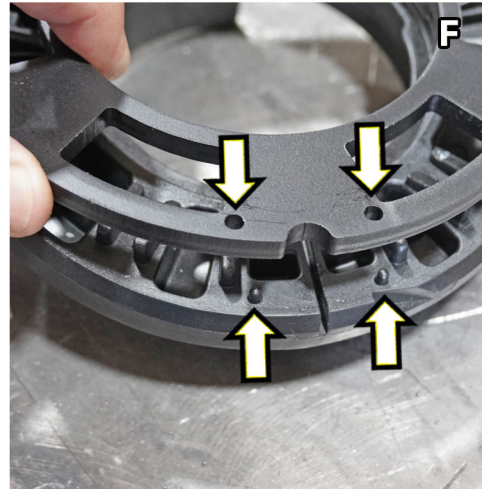
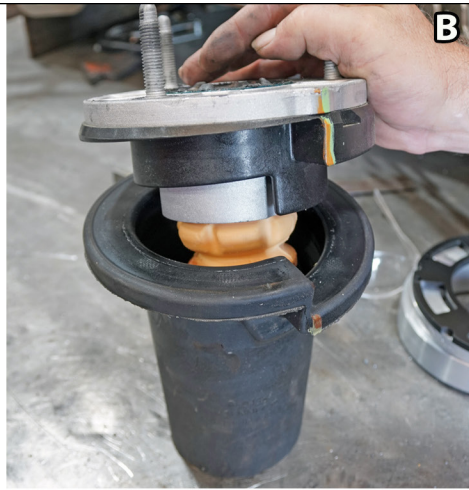
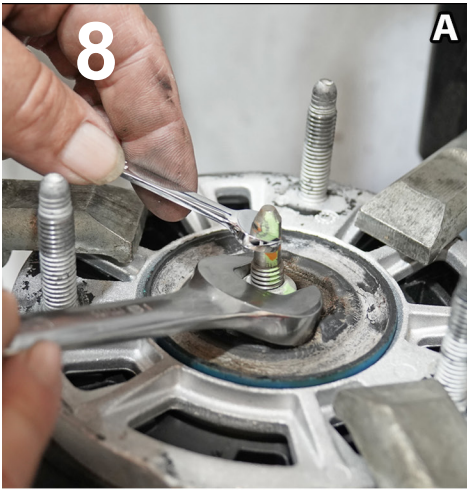

41. [Illustration 9-A] Reinstall the strut but sliding the assembly through the upper control arm and into the frame mount. Secure the three (3) upper end bolts of the assembly using the factory flange nuts; do not tighten at this time. [18mm]
42. [Illustration 9-B] Attach the lower end of the strut to the lower control arm using the factory hardware and tighten. [15mm] (37)
43. [Illustration 9-C] Tighten the top strut flange nuts. [15mm] (37)
44. [Illustration 9-D] Connect the factory wire clips back to the top of the studs.

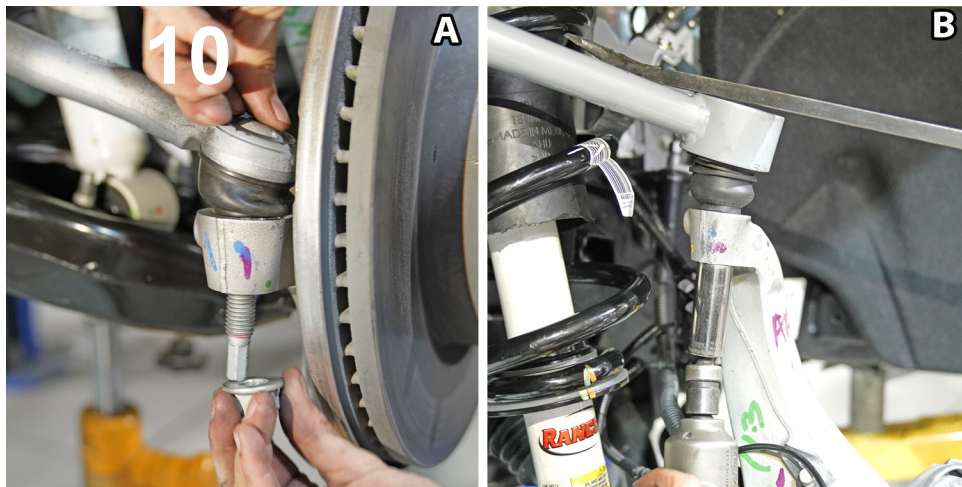
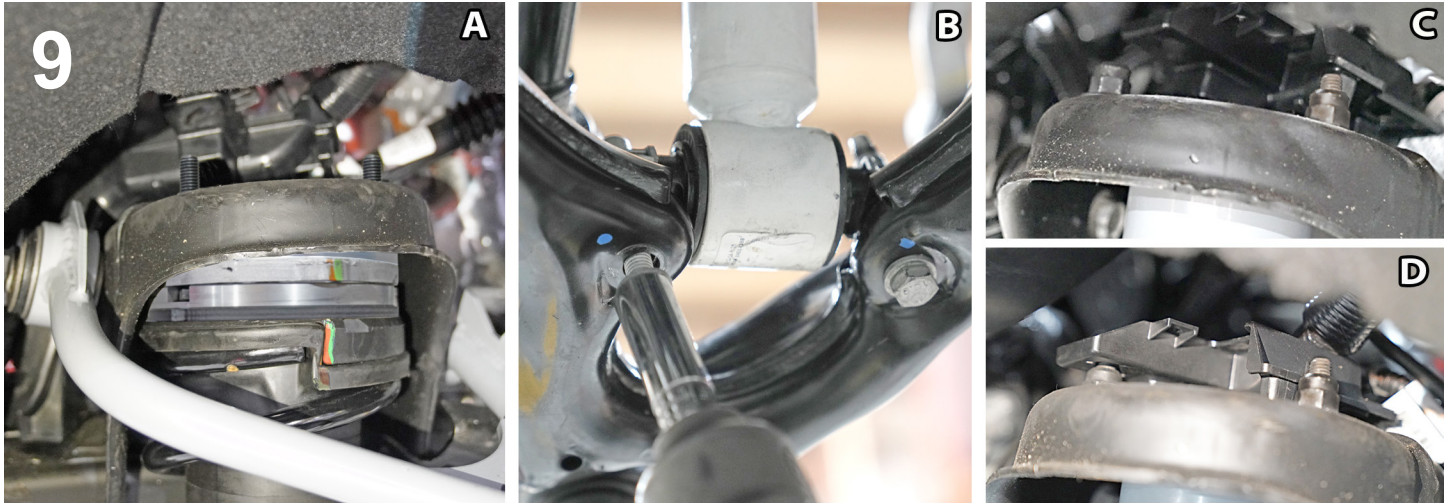

45. [Illustration 10-A] Use the factory hardware to loosely attach the tie rod to the knuckle for stability.
46. [Illustration 10-B] Loosely attach the upper ball joint to the knuckle. [18mm] (103)
47. [Illustration 11-A] Above the tie rod boss on the knuckle, reattach the ABS line to the knuckle. [10mm]
48. [Illustration 11-B] Follow the ABS line up the front of the knuckle and reattach the ABS line bracket to the knuckle. [10mm]
49. [Illustration 11-C] On the rear side of the knuckle, plug the brake sensor into the brake caliper. [10mm]
50. [Illustration 11-D] Reattach the brake line bracket to the rear side of the knuckle. [10mm]
51. [Illustration 11-E] Reattach the ABS and brake pad wear sensor bracket to the inward side of the knuckle. [10mm]
52. [Illustration 11-F] Bolt the ABS and brake sensor bracket to the tab on the Superlift upper control arm using the supplied 1/4" x 3/4" bolt, washer, and nut. [10mm]
53. Tighten the tie rod end to the knuckle. [21mm] (44)
54. Connect the sway bar links to the lower control arm; tighten. [15mm] (63)

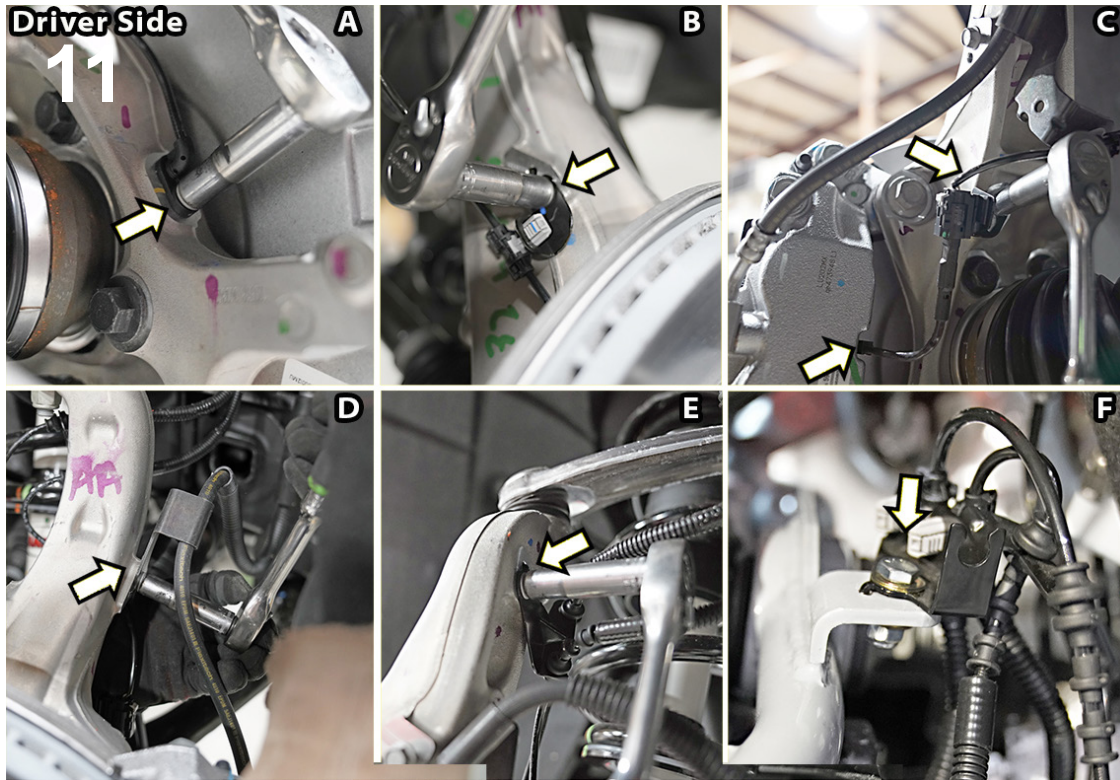

- 55. [Illustration 12] Remove the sway bar body from the frame.
- 56. [Illustration 13 & 14] Install the supplied 3/8" bolt through the new sway bar drop (55-22-3610) and install on the new bracket on the frame with the pointed end facing the rear of the vehicle and the 3/8" bolts hanging downward. Secure with the factory bolts.
- 57. [Illustration 15] Install the sway bar body over the 3/8" bolts and secure with the supplied washers and nyloc nuts.



58. Install tires and wheels, then tighten the lug nuts. [21mm] (151)
59. When the tires and wheels are installed, always check for and remove any corrosion, dirt, or foreign material on the wheel-mounting surface, or anything that contacts the wheel-mounting surface (hub, rotor, etc.). Installing wheels without the proper metal-to-metal contact at the wheel mounting surfaces can cause the lug nuts to loosen and the wheel to come off while the vehicle is in motion.
60. Retighten lug nuts at 500 miles after any wheel change, or anytime the lug nuts are loosened. Failure to do so could cause wheels to come off while vehicle is in motion.
61. With the suspension "hanging" at full extension travel, cycle the steering lock-to-lock and check all components for proper operation and clearances. Pay special attention to the clearance between the tires and wheels, knuckles, brake hoses, wiring, etc.
62. Lower vehicle to the floor so the suspension is now supporting vehicle weight.
63. With the vehicle on the ground, cycle the steering lock-to-lock and check all components for proper operation and clearances. Pay special attention to the clearance between the tires and wheels and knuckles, brake hoses, wiring, etc.

REAR INSTALLATION

Save all factory components and hardware for reuse, unless noted.

1. Chock the front tires. Position a jack beneath the center of the rear axle of the vehicle. Raise rear of vehicle and place jack stands beneath the frame rails just forward of the rear springs' front hangers. Ease the jack down until the frame is resting on the stands. Keep a slight load on the jack.
2. Remove the rear tires.
3. [Illustration 1] Remove shock absorbers. [21mm]
4. [Illustration 2] Remove ubolts and then lower the axle several inches away from springs. [21mm]
5. Clean spring pads of all debris.
6. [Illustration 3-A] Place one (1) c-clamp on each side of the center pin and tighten c-clamps and unbolt the center pin bolt. [c-clamp, 15mm nut]
7. [Illustration 3-B] Remove center pin bolt with the factory shim. [15mm]
8. [Illustration 3-C] Reinstall the center pin bolt through the spring assembly with the head of the center pin in the same location as the stock pin. [c-clamp, 15mm nut]
9. [Illustration 4] Position the new Superlift block (019) on top of the axle pad.
10. [Illustration 4] Using the floor jack(s), mate the springs to the blocks, be sure that the center bolt heads seat properly and install the new Superlift ubolts, factory ubolt plate and supplied ubolt washers and nuts. Evenly torque the ubolts using an "X" tightening sequence. [7/8"] (150)
11. Install the supplied hourglass bushings (01-60418) into the new Superlift shock eyes (659583); then install the supplied sleeves (24-5704) into the shock eyes.

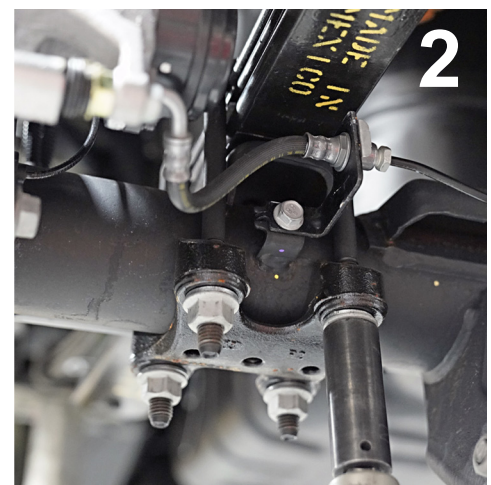

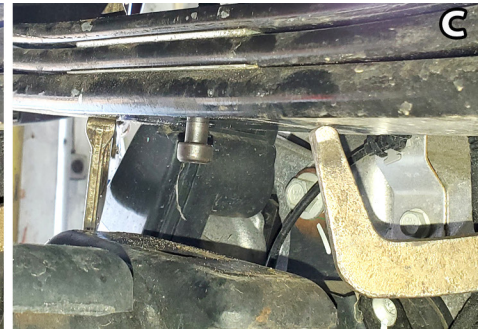
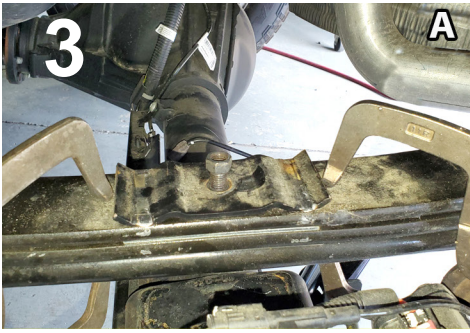

12. Install the new shock into the factory location with the factory hardware; note that the Superlift brand shocks must be installed with the cylinder at the axle and shaft at the frame. [21mm] (55)
13. Reinstall tires and wheels, then tighten the lug nuts. [21mm] (151)
14. When the tires and wheels are installed, always check for and remove any corrosion, dirt, or foreign material on the wheel mounting surface, or anything that contacts the wheel mounting surface (hub, rotor, etc.). Installing wheels without the proper metal-to-metal contact at the wheel mounting surfaces can cause the lug nuts to loosen and the wheel to come off while the vehicle is in motion.
15. Retighten lug nuts at 500 miles after any wheel change, or anytime the lug nuts are loosened. Failure to do so could cause wheels to come off while vehicle is in motion.
16. Lower vehicle to the floor.



FINAL INSPECTIONS

1. Check all hardware for proper torque specifications. With the vehicle on the ground, check all components for proper operation and clearances. Pay special attention to the clearance between the tires and wheels, brake hoses, wiring, etc. Check tire and wheel clearance with the fenders/bumper as well as with the steering knuckle.
2. Realign vehicle to factory OEM specifications. It is necessary to have a proper and professional wheel alignment performed by a certified alignment technician. Align the vehicle to factory specifications. It is recommended that your vehicle alignment be checked after any off-road driving.
3. Re-adjust headlights to proper setting. In addition to your vehicle alignment, for your safety and others, it is necessary to check and adjust your vehicle head lamps for proper aim and alignment.
4. Activate four wheel drive system and check for proper engagement.
5. Install the "WARNING TO DRIVER" decal on the inside of the windshield, sun visor, or on the dash, within Driver's view.

IMPORTANT MAINTENANCE INFORMATION

It is the ultimate buyer's responsibility to have all bolts / nuts checked for tightness after the first 100 miles and then every 1000 miles. The steering, suspension and driveline systems, plus wheel alignment should be inspected by a qualified professional mechanic at least every 3000 miles.

LIMITED LIFETIME WARRANTY / WARNINGS

Your SUPERLIFT® product is covered by the Limited Warranty explained below that gives you specific legal rights. This limited warranty is the only warranty SUPERLIFT® makes in connection with your product purchase. SUPERLIFT® neither assumes nor authorizes any retailer or other person or entity to assume for it any other obligation or liability in connection with this product or limited warranty.

SUPERLIFT, LLC, LIMITED LIFETIME WARRANTY

What is covered? Subject to the terms below, SUPERLIFT® will repair or replace its products found defective in materials or workmanship for so long as the original purchaser owns the vehicle on which the product was originally installed. Your warranter is SUPERLIFT, LLC, doing business as SUPERLIFT® Suspension Systems ("SUPERLIFT®").

What is not covered? Your SUPERLIFT® Limited Warranty does not cover products SUPERLIFT® determines to have been damaged by or subjected to:

- Alteration, modification or failure to maintain.
- Normal wear and tear (bushings, rod ends, etc.). Scratches or defects in product finishes (powder coating, plating, etc.).
- Damage to, or resulting from, the vehicle's electronic stability system, related components or other vehicle systems.
- Racing or other vehicle competitions or contests. Accidents, impact by rocks, trees, obstacles or other aspects of the environment.
- Theft, vandalism or other intentional damage.

Remedy Limited to Repair or Replacement. The exclusive remedy provided hereunder shall, upon SUPERLIFT's inspection and at SUPERLIFT's option, be either repair or replacement of the product covered under this Limited Warranty. Customers requesting warranty consideration should contact SUPERLIFT® by phone (1-800-551-4955) to obtain a Returned Goods Authorization number. All removal, shipping and installation costs are customer's responsibility.

If a replacement part is needed before the SUPERLIFT® part in question can be returned, you must first purchase the replacement part. Then, if the part in question is deemed warrant-able, you will be credited / refunded.

OTHER LIMITATIONS - EXCLUSION OF DAMAGES - YOUR RIGHTS UNDER STATE LAW

- Neither SUPERLIFT® nor your independent SUPERLIFT® dealer are responsible for any time loss, rental costs, or for any incidental, consequential or other damages you may have.
- This Limited Warranty gives you specific rights, and this is the only warranty SUPERLIFT® makes in connection with your product purchase. You may also have other rights that vary from state to state. For example, while all implied warranties are disclaimed herein, any implied warranty required by law is limited to the terms of our Limited Lifetime Warranty as described above. Some states do not allow limitations of how long an implied warranty lasts and / or do not allow the exclusion or limitation of incidental or consequential damages, so the limitations and exclusions herein may not apply to you. SUPERLIFT® neither assumes nor authorizes any retailer or other person or entity to assume for it any other obligation or liability in connection with this product or Limited Warranty.

IMPORTANT PRODUCT USE AND SAFETY INFORMATION / WARNINGS

As a general rule, the taller a vehicle is, the easier it will roll over. Offset, as much as possible, what is lost in rollover resistance by increasing tire track width. In other words, go "wide" as you go "tall"; always use as wide a tire and wheel combination as feasible to enhance vehicle stability. We strongly recommend, because of rollover possibility, that the vehicle be equipped with a functional roll bar and cage system. Seat belts and shoulder harnesses should be worn at all times. Avoid situations where a side rollover may occur.

Generally, braking performance and capabilities are decreased when significantly larger / heavier tires and wheels are used. Take this into consideration while driving. Also, changing axle gear ratios or using tires that are taller or shorter than factory height will cause an erroneous speedometer reading. On vehicles equipped with an electronic speedometer, the speed signal impacts other important functions as well. Speedometer recalibration for both mechanical and electronic types is highly recommended.

Do not add, alter, or fabricate any factory or aftermarket parts to increase vehicle height over the intended height of the SUPERLIFT® product purchased. Mixing component brands is not recommended.

SUPERLIFT SUSPENSION
300 Huey Lenard Loop Rd.
West Monroe, Louisiana 71292
Phone: (318) 397-3000
Sales / Tech: (800) 551-4955
Fax: (318) 397-3040
SUPERLIFT.COM