



SUPERLIFT[®]

S U S P E N S I O N

Superlift 4" Lift System for 2012 and newer DODGE DS 1500 4WD INSTALLATION INSTRUCTIONS

INTRODUCTION

Installation requires a professional mechanic. Prior to beginning, inspect the vehicle's steering, driveline, and brake systems, paying close attention to the suspension link arms and bushings, anti-sway bars and bushings, tie rod ends, pitman arm, ball joints and wheel bearings. Also check the steering sector-to-frame and all suspension-to-frame attaching points for stress cracks. The overall vehicle must be in excellent working condition; repair or replace all worn parts. **If your vehicle is equipped with the factory Outdoorsman package, order Superlift strut spacer kit box part no. 4595.**

Read instructions several times before starting. Be sure you have all needed parts and know where they install. Read each step completely as you go.

NOTES:

- ⊗ **Prior to beginning the installation, check all parts and hardware in the box with the parts list below. If you find a packaging error, contact Superlift directly. Do not contact the dealer where the system was originally purchased. You will need the control number from each box when calling; this number is located at the bottom of the part number label and to the right of the bar code.**
- ⊗ **Wheels** - An 18" diameter or larger wheel must be used with this system. Factory 17" and 18" wheels do not work. Wheel recommendations:
 - * 18" diameter x 9" wide (maximum) with a maximum backspacing of 5", or
 - * 20" diameter x 9" wide (maximum) with a maximum backspacing of 5-1/2"
- ⊗ **Tires** - 35" diameter x 12.50" wide
- ⊗ Front-end realignment is necessary.
- ⊗ In photos, an arrow indicates which direction is towards "front of vehicle".
- ⊗ A foot-pound torque reading is given in parenthesis () after each appropriate fastener.
- ⊗ Do not fabricate any components to gain additional suspension height.
- ⊗ Prior to drilling or cutting, check behind the surface being worked on for any wires, lines, or hoses that could be damaged. After drilling, file smooth any burrs and sharp edges.
- ⊗ Prior to operating a torch or saw, protect any heat-sensitive components located in the immediate area by covering them with a water-saturated cloth. Most undercoatings are flammable but can be extinguished using a water-filled spray bottle. Have a spray bottle and an ABC rated fire extinguisher on hand.
- ⊗ Paint or undercoat all metal surfaces.
- ⊗ Prior to attaching components, be sure all mating surfaces are free of grit, grease, excessive undercoating, etc.
- ⊗ A factory service manual should be on hand for reference.

☉ Use the check-off “” found at each step to help you keep your place. Two “” denotes that one check-off box is for the driver side and one is for the passenger side.

PARTS LIST ... The part number is stamped into each part or printed on an adhesive label. Identify each part and place the appropriate mounting hardware with it.

PART NO.	DESCRIPTION (Qty.- if more than one)	NEW ATTACHING HARDWARE (Qty.)	BAG #
66-01-4594.....	knuckle, driver.....	(1) Threadlocker	77-4594-2
66-02-4594.....	knuckle, passenger.....	(1) Threadlocker	77-4594-2
55-62-4594.....	front diff. bracket, driver / front.....	(4) 12mm x 40mm bolt (6) 12mm flat washer (2) 12mm Stover nut (2) 12mm lock washer	77-4603-1
55-03-4603.....	front diff. bracket, driver / rear...	(3) 12mm x 50mm bolt (3) 12mm lock washer (6) 12mm flat washer (3) 12mm nut	77-4603-1
55-63-4594.....	front diff. bracket, pass. side.....	(2) 1/2" x 2-1/4" bolt (2) 1/2" Stover nut (2) 12mm Stover nut (2) 12mm flat washer (4) 1/2" SAE flat washer (2) 12mm x 70mm bolt	77-4603-1
55-05-4603.....	differential actuator bracket		
55-46-4594.....	front crossmember, lower..... control arms' front legs	(2) 18mm x 150 bolt (4) 3/4" SAE flat washer (2) 2" x 1-1/2" x 3/16" thick lockout tabs (2) 18mm Nyloc nut	77-4594-2
55-49-4594.....	front crossmember, lower..... control arms' rear legs	(2) 18mm x 150 bolt (4) 3/4" SAE flat washer (2) 2" x 1-1/2" x 3/16" thick lockout tabs (2) 18mm Nyloc nut	77-4594-2
55-08-4594.....	front belly pan.....	(6) 3/8" x 1" countersunk blt. (6) 3/8" Flange nut (1) Superlift Badge (1) Alcohol cleaning pad	77-4594-4 88-4596
55-10-4594.....	(2) front strut spacer.....	(6) 7/16" Flange nut (6) 7/16" SAE flat washer	77-4594-3

PART NO.	DESCRIPTION (Qty.- if more than one)	NEW ATTACHING HARDWARE (Qty.)	BAG #
[(55-10-4595).....]	(2) Outdoorsman front strut spacer -SOLD SEPARATELY SL# 4595]		
OR			
BE5-F812-H0.....	(2) Bilstein Struts		
55-11-4594.....	front brake line bracket, pass.....	(1) 3/8" Flange nut (1) 3/8" x 1" bolt (1) 1/4" x 3/4" bolt (1) 1/4" Nyloc nut	77-4594-3
55-12-4594.....	front brake line bracket, driver.....	(1) 3/8" Flange nut (1) 3/8" x 1" bolt (1) 1/4" x 3/4" bolt (1) 1/4" Nyloc nut	77-4594-3
55-23-4640.....	(2) front anti-sway bar link ext.....	(6) 7/16" SAE flat washer	77-4594-3
66-04-4603.....	front driveshaft spacer.....	(4) 12mm x 50mm bolt	77-4594-3
55-47-4594.....	rear track bar bracket.....	(2) 7/16" x 1-1/4" bolt (1) 1-1/8" O.D. x 1-7/16" long sleeve (4) 7/16" SAE flat washer (1) 9/16" x 3-1/2" bolt (2) 9/16" SAE washer (1) 9/16" Nyloc nut (2) 7/16" Nyloc nut	77-4594-13
55-22-4594.....	rear track bar bracket support plate		
55-19-4594.....	(2) rear anti-sway bar/brake line... bracket	(2) 7/16" x 1" bolt (4) 7/16" SAE flat washer (2) 7/16" Nyloc nut (2) 5/16" x 1" bolt (4) 5/16" SAE flat washer (2) 5/16" Nyloc nut	77-4594-13
55-37-4594.....	rear bump stop extension, driver..	(2) 3/8" x1" bolt (2) 3/8" SAE flat washer (2) 3/8" Nyloc nut	77-4594-6
55-36-4594.....	rear bump stop extension, pass...	(2) 3/8" x1" bolt (2) 3/8" SAE flat washer (2) 3/8" Nyloc nut	77-4594-6

PART NO.	DESCRIPTION (Qty.- if more than one)	NEW ATTACHING HARDWARE (Qty.)	BAG #
----------	---	-------------------------------------	-------

Shock absorber part number depends on type ordered.... (2) rear shock absorber decal
(2) hardware pack, cable tie

01-141.....(2) rear coil spring

00461.....decal, "Warning To Driver"

00421.....decal, "Superlift"

FRONT PROCEDURE

NOTE: Save all factory components and hardware for reuse, unless noted.

1) PREPARE VEHICLE...Place vehicle in neutral. Raise front of vehicle with a jack and secure a jack stand beneath each frame rail, behind the lower control arms. Ease the frame down onto the stands, place transmission in low gear or "park", and chock rear tires. Remove front tires.

2) FRONT DIFFERENTIAL SKID PLATE AND DRIVESHAFT...If equipped, remove the factory front differential skid plate and discard. Disconnect the front driveshaft from the differential then secure driveshaft up and out of the way.

3) ANTI-SWAY BAR LINKS...Disconnect the upper end of the anti-sway bar links from the sway bar body; leave the lower ends attached to the lower control arm.

Perform steps 4 through 7 one side at a time.

4) WHEEL SPEED SENSORS...Detach the Wheel Speed Sensor (WSS) wire at the following points, and in this order:

A) At rubber brake hose

B) At rear leg of upper control arm

C) At engine compartment side of the inner fenderwell. This attachment point is just above attachment point "B", and is accessed by pulling the plastic inner fender outboard slightly. Point "C" is also a WSS wire plug / connector; disconnect the WSS wire here.

5) KNUCKLES...

Remove the brake caliper from the rotor and secure it away from the work area. **NOTE: Do not let calipers hang from brake lines.**

Remove the front rotor from the hub. Remove the retaining nut from the center of the bearing hub.

Loosen, but do not remove, the upper control arm bolts.

Using the appropriate puller tool, disconnect the upper and lower ball joints and outer tie rod end from the knuckle. Remove knuckle. The wheel speed sensor wire remains on the factory knuckle for now.

6) **STRUTS...** Loosen, but do not remove, the lower control arm bolts. Remove the lower strut bolt. Remove the three upper strut assembly bolts. Remove strut.

7) **LOWER CONTROL ARMS...** Remove the lower control arm's two alignment cam bolt assemblies then remove the lower control arm.

Repeat steps 4 through 7 on opposite side.

8) **REAR CROSSMEMBER...** Remove the factory lower control arms' rear crossmember.

9) **DIFFERENTIAL...** Disconnect all electrical lines from differential. Unbolt front driveshaft and secure it up and out of the way. Support the differential and remove all differential-to-frame mounting hardware. Remove differential assembly.

10) **TRIMMING FRONT AND REAR / LOWER CONTROL ARM MOUNT...**[See Photo 1 and 1A]

The front driver and passenger side lower control arm mount must be trimmed. Measure down 1" from the bottom edge of the slot and mark a line parallel to the slot. Cut the frame through the front side only along the marked line using a cut-off wheel or Sawz-all. After cutting, clean and paint all exposed areas.

The passenger side factory rear / lower control arm mount must be trimmed as shown. Measure down from the bottom edge of the slot and mark a line parallel to the slot. Cut the frame through the front side only along the marked line using a cut-off wheel or Sawz-all. After cutting, clean and paint all exposed areas.

The driver side factory rear / lower control arm mount must be trimmed as shown. Measure to the inside 1-3/4" from inside edge of slot and mark a line perpendicular to the bottom edge of the slot. Cut the frame through all sides along the marked lines (front, top and back sides) using a cut-off wheel or Sawz-All. After the first cut, measure down from the bottom edge of the slot 15/16" and mark and line parallel with the bottom edge of the slot on the front side of the factory mount. Cut the frame through the front side only along the marked line using a cut-off wheel or Sawz-All. After cutting, clean and paint all exposed areas.

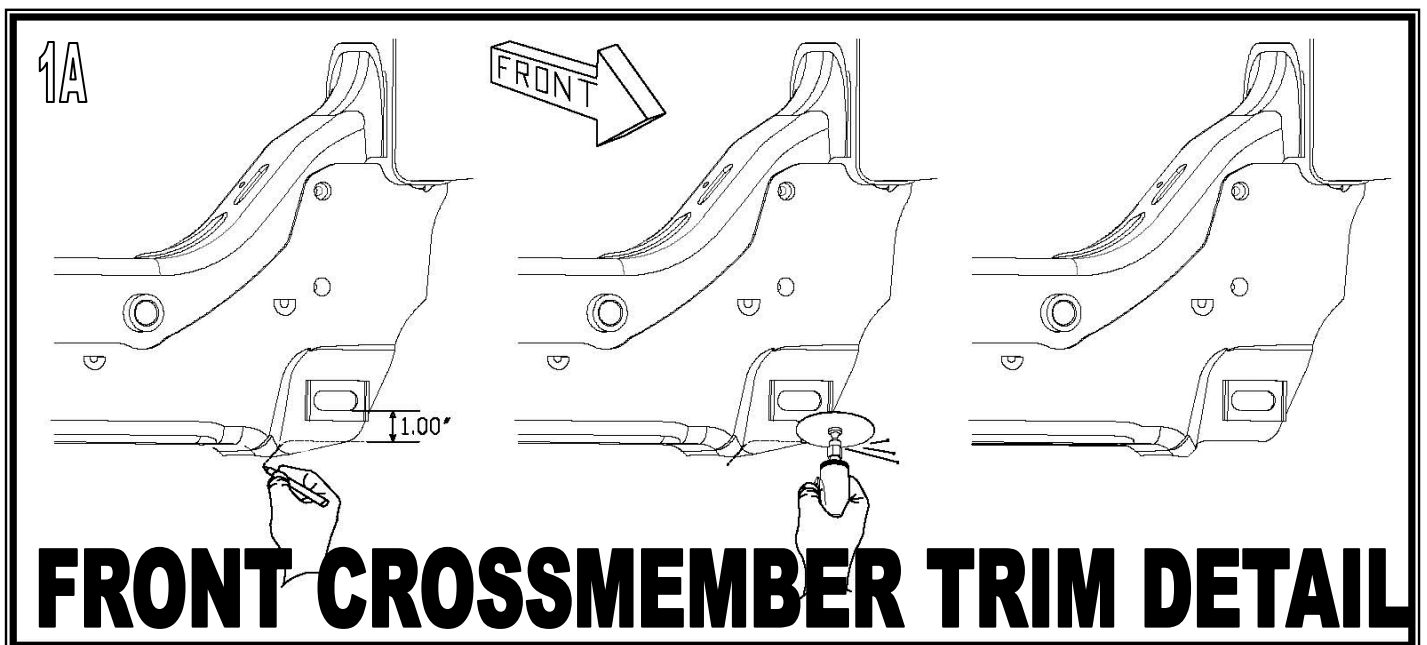

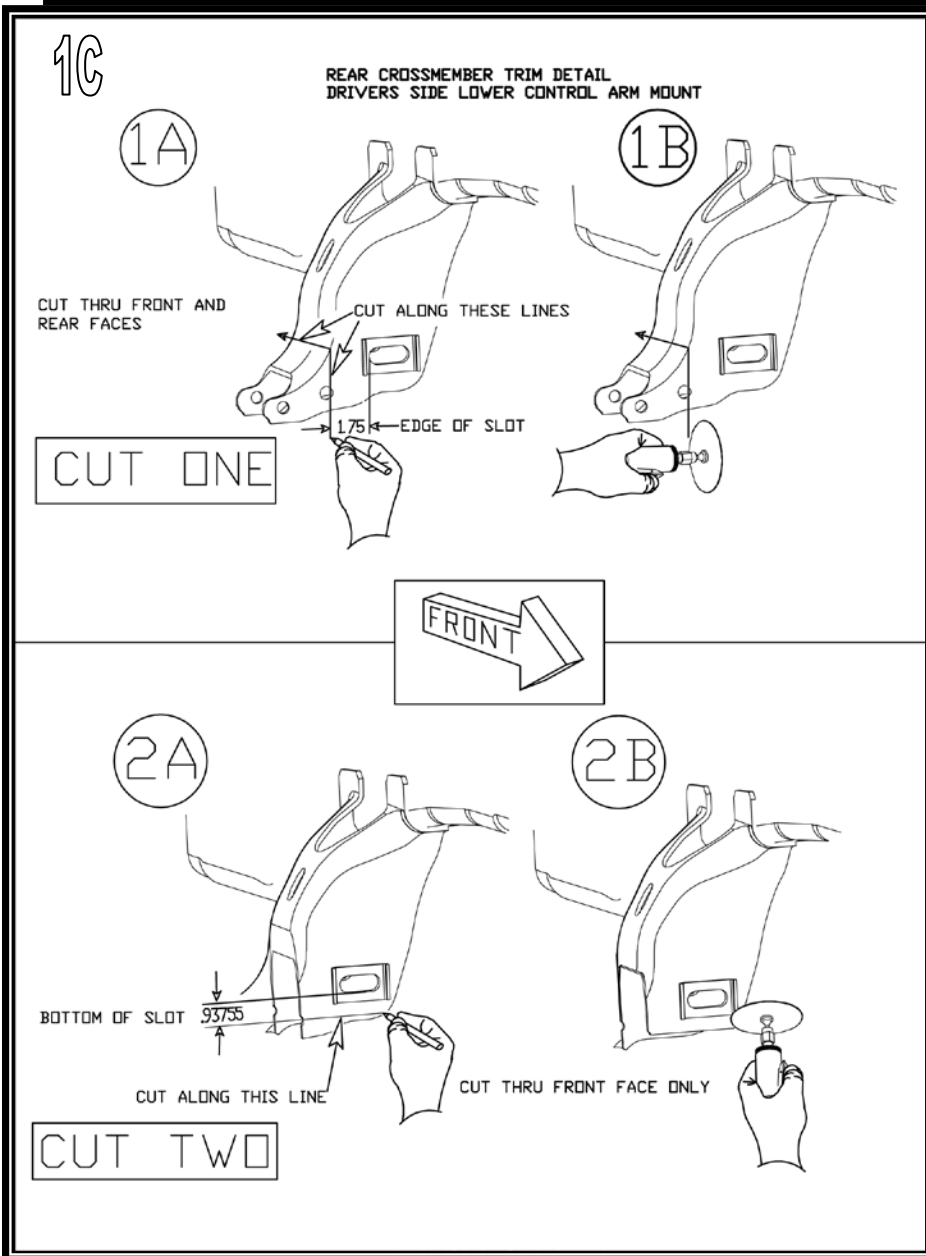
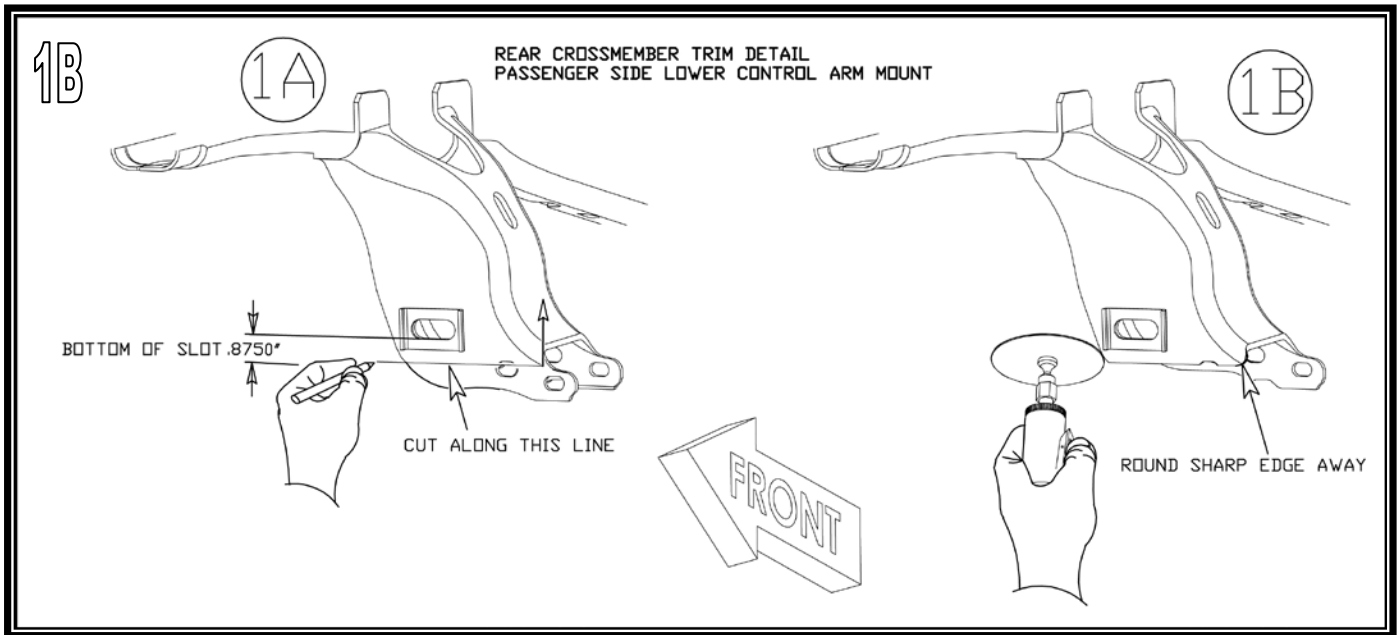

11) DIFFERENTIAL BRACKETS...[See Photo 2]

- ❑ Loosely attach the driver side / front differential bracket (SL# 55-62-4594) to the frame using the supplied 12mm x 40mm bolts, lock washers, and flat washers. Do not tighten.
- ❑ [See Photo 3] Loosely attach the driver side / rear differential bracket (SL# 55-03-4603) to the frame using the factory bolts, supplied flat washers and supplied nuts. Do not tighten.
- ❑ [See Photo 4] Loosely attach the passenger side differential bracket (SL# 55-63-4594) and the differential actuator bracket (SL#55-05-4603) to the frame using the supplied 12mm x 70mm bolts and flat washers and Stover nuts. Do not tighten. Note that the actuator bracket should be placed between the 55-63-4594 and the bolt head with the third hole positioned on the passenger side.

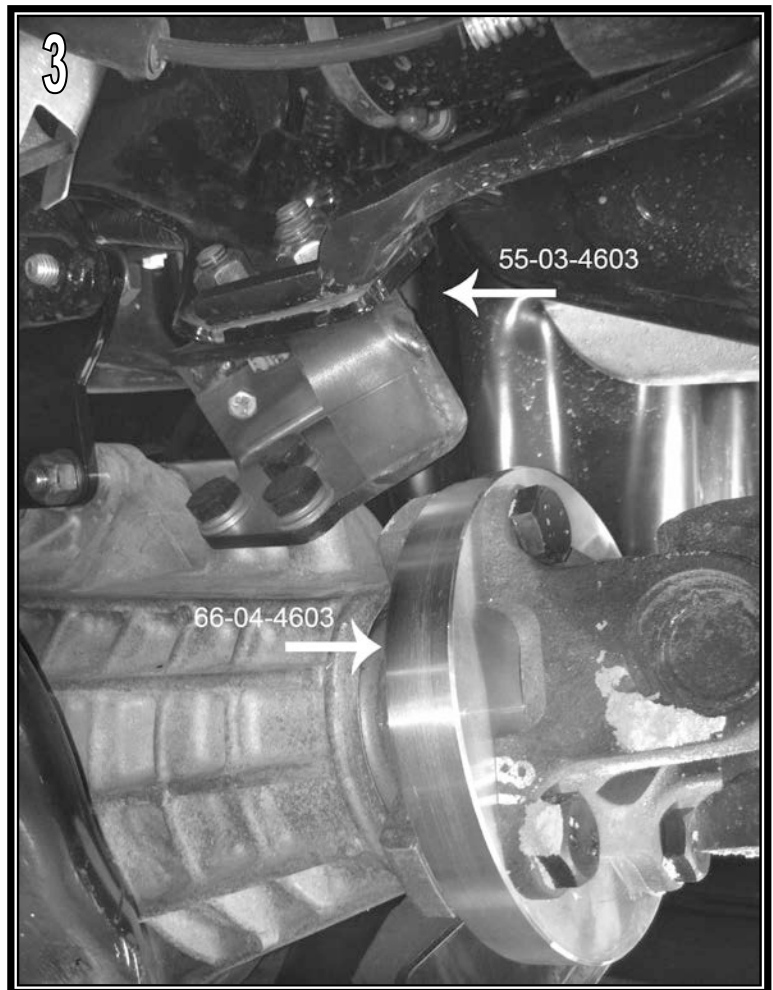

- ### 12) ❑❑ CV AXLES...On each side, disconnect the inner CV axle assembly from the differential. Use two pry bars, positioned between the inner CV and the differential housing, to free the axles.

13) INSTALL DIFFERENTIAL AND SUPERLIFT REAR CROSSMEMBER (SL# 55-49-4594)...

- ❑ **Position the differential in the frame** - Loosely attach the differential to the Superlift driver side / front bracket (SL#55-03-4594) using the supplied 12mm x 50mm bolts, flat washers (on both nut and bolt head sides) and Stover nuts. Do not tighten. The differential is attached to the remaining Superlift brackets in later steps.
- ❑ **Superlift rear crossmember, passenger side** - Raise the passenger side of the differential housing which will allow you to mate the passenger side of the Superlift crossmember - to - frame. Insert the supplied 18mm x 150mm bolt and flat washer from the front, through the factory mount crossmember. Position the 2" x 1-1/2" x 3/16" thick lockout tab onto the bolt; the tab seats in what was the factory rear cam washer's location. Install the supplied flat washer then the supplied 18mm Nyloc nut. Do not tighten. Note the crossmember goes inside of the factory mount.



- ❑ **Superlift rear crossmember, driver side** - Position the driver side of the Superlift crossmember into the frame. Insert the supplied 18mm x 150mm bolt and flat washer from the front, through the factory mount and crossmember. Position the 2" x 1-1/2" x 3/16" thick lockout tab onto the bolt; the tab seats in what was the factory rear cam washer's location. Install the supplied flat washer then the supplied 18mm Nyloc nut. Do not tighten. Note the crossmember goes inside of the factory mount.
- ❑ **Differential - to - Superlift passenger side bracket** - Loosely attach using the supplied 1/2" x 2-1/4" bolts, flat washers (on both nut and bolt head sides) and Stover nuts. Do not tighten.
- ❑ **Differential - to - Superlift driver side / rear bracket** - Attach using the three supplied 12mm x 40mm differential bolts and the supplied nuts.
- ❑ Tighten all differential hardware to (70) in the order listed: the four bolts securing the driver side / front bracket ; the four bolts securing the passenger side bracket; the six bolts securing the driver side / rear bracket. Leave the two crossmember - to - frame bolts loose at this time.
- ❑ Insert the 5/16" vacuum line adapter (SL# 23-3205) and new vacuum line (SL# 18-9690). Reconnect the electrical lines; retaining clips may need to be removed to create enough "slack" to reconnect.

14) ❑❑ **SUPERLIFT FRONT CROSSMEMBER (SL# 55-46-4594)...**

Position the Superlift crossmember into the frame; make sure the tab with the skid plate holes are towards the rear of the vehicle. Insert the supplied 18mm x 150mm bolt and flat washer from the front, through the factory mount and crossmember. Position the 2" x 1-1/2" x 3/16" thick lockout tab onto the bolt; the tab seats in what was the factory rear cam washer's location. Install the supplied flat washer then the supplied 18mm Nyloc nut. Do not tighten. Note the crossmember goes inside of the factory mount.

15) ❑ **FRONT DRIVESHAFT...**[See Photo 3] Install driveshaft spacer (SL# 66-04-4603) between the differential mounting flange and the driveshaft using the supplied 12mm x 50mm bolts. Apply threadlocker to the bolts before installation. Tighten (85).

Perform steps 16 through 20 one side at a time.

16) **LOWER CONTROL ARMS...**

NOTE: It is possible to incorrectly install the driver side lower control arm on the passenger side of the vehicle, and vice-versa. When the control arm is located properly, the sway bar links will be positioned towards front of vehicle, and the lower ball joint stud points down.

❑❑ Loosely install the factory lower control arm reusing the factory cam bolts assemblies. Insert bolts from the front with the cam lobes in the upright / centered position. Do not tighten.

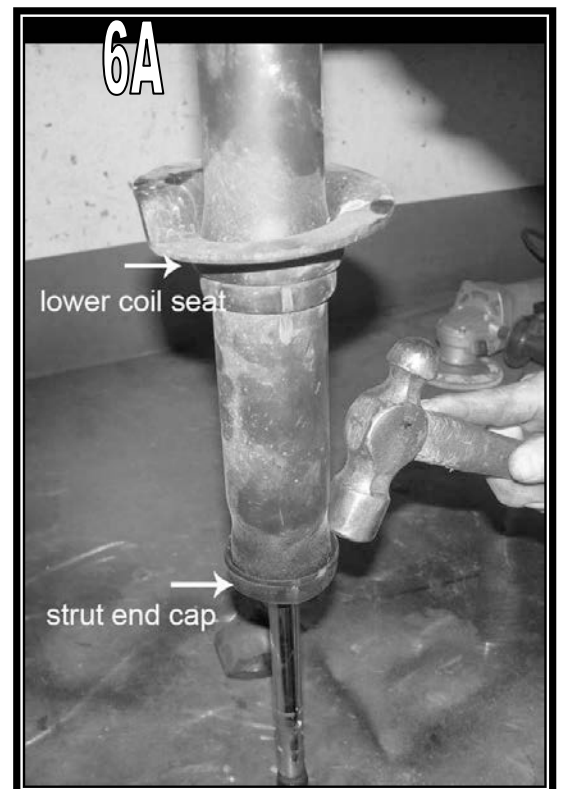

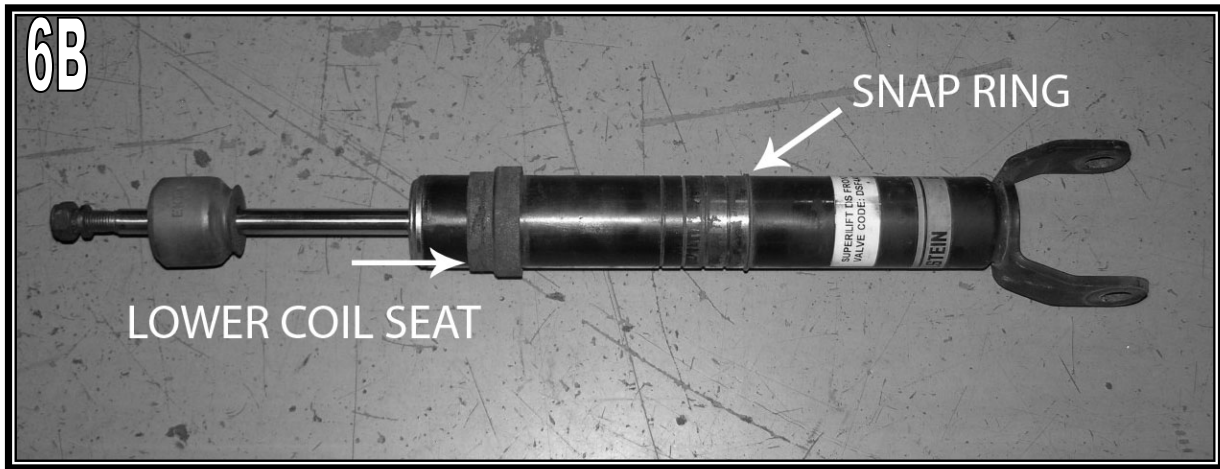

IF REPLACEMENT BILSTEIN STRUTS WERE NOT PURCHASED, SKIP TO STEP 17A.

17) REPLACEMENT STRUTS...

- Locate the factory strut assembly. Use a paint marker to scribe three vertically aligned indexing marks on the outboard side of the assembly. Mark: 1) the outboard facing side of the upper strut mounting plate, 2) the top (exposed) coil spring wrap, 3) the center of the lower strut eye mount.
- WARNING! The coil is under extreme pressure and severe bodily injury may occur if the coil spring is disassembled without using a suitable coil spring compressor.** Compress the coil spring until the strut body has approximately 3/8" of free movement. Remove the upper strut mounting plate retaining nut. **NOTE:** Do not use an impact gun to remove the retaining nut; this may damage the strut shaft.
- Remove the washer then the strut's upper bushing half.
- Remove the strut's upper mounting plate then the factory coil spring isolator.
- Carefully remove the strut cylinder from the coil spring.
- [See Photo 6A] Once the strut has been removed, slide the rubber snubber from the shaft, stand the strut up on the shaft end and carefully remove the strut end cap, then remove the lower coil seat
- [See Photo 6B] Position the snap ring on the new strut in the end groove farthest from the shaft, then slide the lower seat collar onto the snap ring. The collar may need to be carefully tapped in place with a hammer. Slide the lower coil seat onto the collar and tap into place.
- Position the machined spacer on the shock body followed by the lower coil seat, insert the shock inside the coil and rotate the coil until the coil is seated properly in the lower coil seat. Install the Nyloc nut and tighten.

- ☐☐ Slowly decompress the coil spring on the strut assembly. Make sure that the spring is seated correctly into the strut assembly.
- ☐☐ Position the strut spacer (SL# 55-10-4594) onto the top of the factory strut using the factory hardware. Tighten (45).
- ☐☐ Install the strut assembly by first loosely attaching the strut's upper studs to the factory frame mount using the supplied 7/16" SAE flat washers and Stover nuts; do not tighten. Now raise the lower control arm, and insert the factory lower strut hardware. Tighten the upper hardware (45). Do not tighten the lower strut hardware at this time.

Repeat step on opposite side

17A) STRUT SPACERS...

- ☐☐ Position the strut spacer (SL# 55-10-4594 or 55-10-4595 for Outdoorsman models) onto the top of the factory strut using the factory hardware. Tighten (45).
- ☐☐ Install the strut assembly by first loosely attaching the strut's upper studs to the factory frame mount using the supplied 7/16" SAE flat washers and Flange nuts; do not tighten. Now raise the lower control arm, and insert the factory lower strut hardware. Tighten the upper hardware (45). Do not tighten the lower strut hardware at this time.

- 18) ☐☐ **CV AXLES...** Insert the inner CV axle shaft into the differential then push firmly to engage CV axle shaft retaining ring.

19) BRAKE LINE / HOSE RELOCATION...[See Photo 7]

- ☐☐ Locate where the upper end of the rubber brake hose passes through the frame and connects to a metal brake line. Use the appropriate tool (ex: cut-off wheel) to cut a notch in the frame to allow removal of the brake hose / line connector. **Take care NOT to damage the brake line / hose.** Remove the brake line bracket bolt then free the line / hose connector from frame.

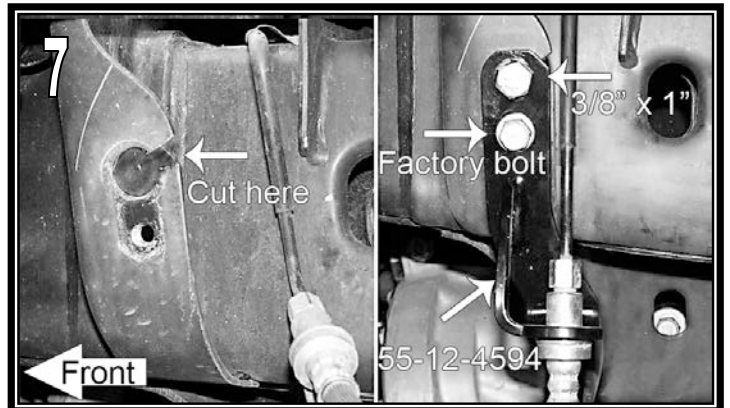

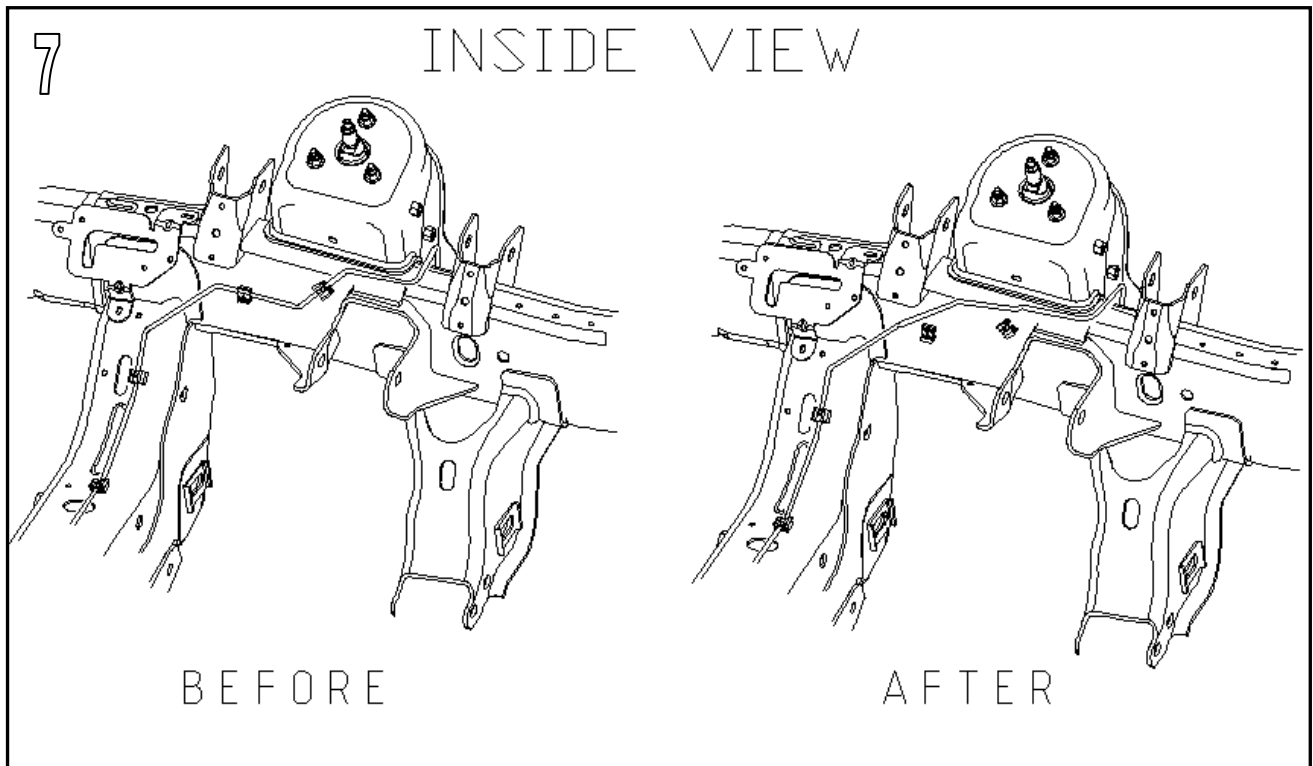

☐☐ There are a couple of bends in the metal line, just above the line / hose connector. Carefully re-form (straighten-out) the bends, as needed, to allow the factory brake line bracket to mate with the Superlift bracket. **DO NOT kink the line.** Attach the factory brake line bracket to the Superlift brake line bracket (SL# 55-12-4594 driver and 55-11-4594 passenger) using the supplied 1/4" x 3/4" bolt and Nyloc nut. Attach Superlift brake line bracket - to - frame using the supplied 3/8" x 1" bolt and Flange nut in the top hole and the factory hardware in the bottom hole. Tighten the 3/8" hardware (30). Tighten the factory and 1/4" hardware (95 In. Lbs.)

20) SUPERLIFT KNUCKLE INSTALLATION...

☐☐ Remove the bolt that secures the Wheel Speed Sensor (WSS) wire mounting bracket to the factory knuckle. Attach this bracket to the Superlift knuckle in the same orientation as factory.

☐☐ Remove the hub assembly and dust shield from the factory knuckle. Do not disconnect the WSS wire from the hub assembly.

☐☐ Position the factory hub assembly and dust shield onto the new Superlift knuckle (SL# 66-01-4594 driver and 66-02-4594 passenger). The hub must be positioned with the WSS wire routed forward and inside the relief machined into the knuckle face. Apply threadlocker to the factory hardware then fasten hub assembly and dust shield to the Superlift knuckle. Tighten (95).

☐☐ [See Photo 8] Route the WSS wire to the mounting bracket on the knuckle, as shown. The rubber grommet on the WSS wire must be shifted. Lubricate the

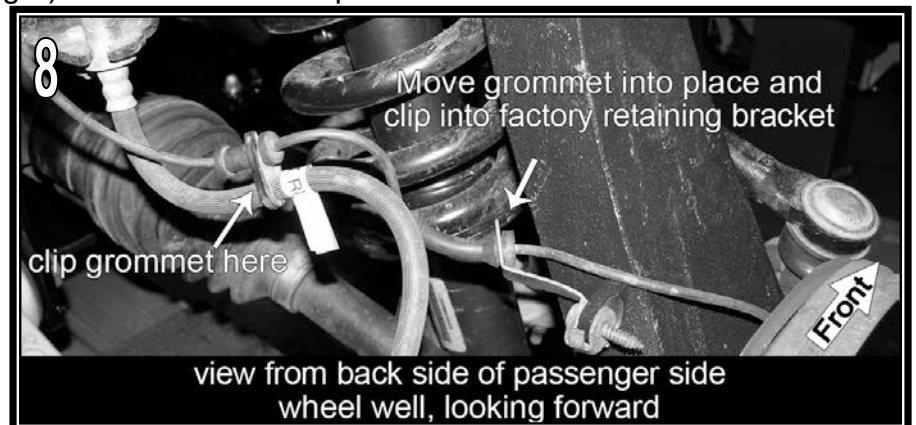

WSS wire and rubber grommet with a detergent-based cleaner (ex: Windex, Formula 409), which allows the WSS wire to slide easily through the rubber grommet. When satisfied with routing, insert the WSS wire / rubber grommet into the mounting bracket.

Install knuckle onto vehicle. Attach the lower ball joint first then slide the CV axle shaft through the hub bearing. Next connect the upper ball joint and tie rod end. Reuse the factory hardware, and apply threadlocker to all. Tighten the lower ball joint nut (85), upper ball joint nut (50), CV axle shaft nut (100) and the tie rod nut (85).

Install the brake rotor and caliper using the factory hardware. Apply threadlocker to caliper bolts. Tighten (130).

Route / reattach the Wheel Speed Sensor (WSS) wire at the following points, and in this order. Again, it will be necessary to lubricate the grommets / WSS wire to allow movement:

A) At rubber brake hose

B) At rear leg of upper control arm

C) Reconnect the WSS wire plug / connector. Do not reattach the connector to the inner fenderwell.

Repeat steps 16 through 20 on opposite side.

21) ANTI-SWAY BAR LINK EXTENSIONS...Apply anti-seize to the factory anti-sway bar link threads. Install three 7/16" SAE washers per side then install the anti-sway bar link extensions (SL# 55-23-4640). Reuse factory bushings and hardware. Attach anti-sway bar links to anti-sway bar body. Tighten until bushings swell slightly.

22) BELLY PAN...[See Photo 9] Attach the belly pan (SL# 55-08-4594) to the Superlift lower control arm crossmembers using the six supplied 3/8" x 1" countersunk bolts and Flange nuts. Tighten (30). Clean the front lip of the belly pan with the supplied alcohol pad and install the Superlift badge.

Tighten all four crossmember - to - frame bolts (75).

23) TIRES / WHEELS...[See Photo 10] Tighten the lug nuts in the sequence shown (130).

WARNING: When the tires / wheels are installed, always check for and remove any corrosion, dirt, or foreign material on the wheel-mounting surface, or anything that contacts the wheel-mounting surface (hub, rotor, etc.). Installing wheels without the proper metal-to-metal contact at the wheel mounting surfaces can cause the lug nuts to loosen and the wheel to come off while the vehicle is in motion.

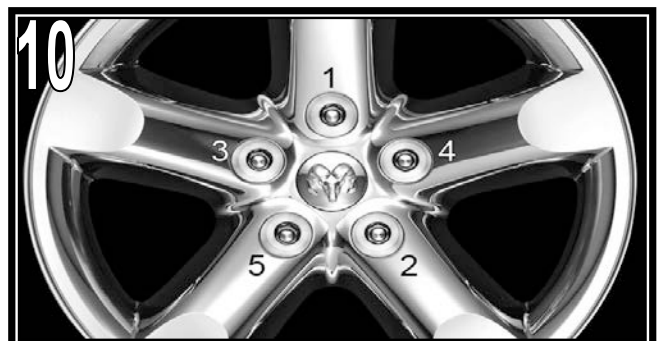

WARNING: Retighten lug nuts at 500 miles after any wheel change, or anytime the lug nuts are loosened. Failure to do so could cause wheels to come off while vehicle is in motion.

Lower vehicle to the floor. The suspension is now supporting vehicle weight.

24) TORQUE CONTROL ARMS AND STRUTS...Tighten the lower control arm bolts (110). Tighten the lower strut bolts (155). Tighten the upper control arm bolts (130).

25) CLEARANCE CHECK...Raise the vehicle back onto jack stands and secure as per step 1. With the suspension "hanging" at full extension travel, cycle steering lock-to-lock and check all components for proper operation and clearances. Pay special attention to the clearance between the tires / wheels and knuckles, brake hoses, wiring, etc.

Lower the vehicle to the floor.

REAR PROCEDURE

26) PREPARE VEHICLE...Before raising the rear of the vehicle:

Disconnect the upper end of the track bar. Loosen, but do not remove, the track bar at the driver side axle mount.

Disconnect the upper ends of the anti-sway bar links where they attach to the frame.

Disconnect the brake line mount and wheel speed sensor. Both are located on the frame, behind the coil spring's upper mount.

Remove the bolt securing the wire hanger bracket that captures the parking brake cables. This hanger is bolted to the driver side, lower suspension link arm. Retain hardware.

27) RAISE REAR OF VEHICLE...Position a jack beneath the center of the rear axle then raise rear of vehicle. Secure jack stands beneath the frame rails just forward of the rear springs. Chock front tires to prevent any possibility of movement. Remove rear tires.

28) SHOCKS AND COIL SPRINGS...Remove shock absorbers. Lower the axle just enough to allow removal of coil springs.

29) SUSPENSION LINK ARMS... Perform this step one side at a time.

Loosen, do not remove, all four suspension link arms where they attach to the axle.

30) TRACK BAR BRACKET...[See Photo 12]

Mate the Superlift track bar bracket (SL# 55-47-4594), support plate, (SL# 55-22-4594) and sleeve (1-1/8" O.D. x 1-7/16" long) to the factory track bar frame bracket, as shown. The support plate attaches to the rear face of both the factory and Superlift brackets (adding this bracket sandwiches the factory bracket between the "47" and "22" bracket). Insert the supplied 9/16" x 3-1/2" bolt, flat washers (on both nut and bolt head sides), and Nyloc nut. Tighten (105).

Two 7/16" holes must be drilled through the factory track bar frame bracket. Using the upper hole in Superlift track bar bracket and the support plate as a template, mark and drill. Insert the two supplied 7/16" x 1-1/4" bolt, flat washers (on both nut and bolt head sides), and Nyloc nut. Tighten (50).

31) □□ WHEEL SPEED SENSOR WIRE...[See Photo 13] Remove the Wheel Speed Sensor (WSS) wire's front and rear clips. The front clip is located on the front / outboard side of the shock absorber's lower mount, and the rear clip is on the outside edge of the coil spring's lower seat. Reposition the front clip into the factory rear clip's hole, at the base of the coil spring seat, and discard the rear clip.

32) BUMP STOPS...[See Photo 14]

□ Position the Superlift passenger side bump stop bracket (SL# 55-36-4594), as shown, on top of the factory bump stop pad, located on top of the axle tube, just inboard of the coil springs. The "hooks" on the back side of the Superlift bracket capture the underside of the factory bump stop pad. Center the Superlift bracket on the pad then using the holes in the Superlift bracket as a template, drill two holes through the factory pad for the 3/8" mounting hardware. Insert the supplied 3/8" x 1" bolts (installed from top), flat washers (on nut side), and Nyloc nuts. Tighten (30).

□ The Superlift driver side bump stop bracket (SL# 55-37-4594) attaches through pre-existing holes in the factory pad. It uses the same hardware as the passenger side.

33) □□ COIL SPRINGS AND SHOCKS...Install Superlift coil springs and shock absorbers using the factory hardware and supplied shock bushings and sleeves. Do not tighten. Apply shock decals.

34) BRAKE LINE / ANTI-SWAY BAR BRACKET...[See Photo 15] Perform this step one side at a time.

□□ The WSS wire is clipped to the front face of the factory anti-sway bar link's frame bracket. Detach WSS clip from the bracket.

□□ Position the Superlift brake line / anti-sway bar relocation bracket (SL# 55-19-4594) over the factory bracket. Use the factory hardware in the top hole, and the supplied 7/16" x 1" bolt, flat washers (on both nut and bolt head sides) and Nyloc nut in the next hole down. Use the supplied 5/16" x 1" bolt, flat washers (on both nut and bolt head sides) and Nyloc nut to attach the factory brake line bracket - to - Superlift bracket. Tighten the 7/16" hardware (50). Tighten the 5/16" hardware (200 in. Lbs.). Tighten the factory hardware (top hole) (23).

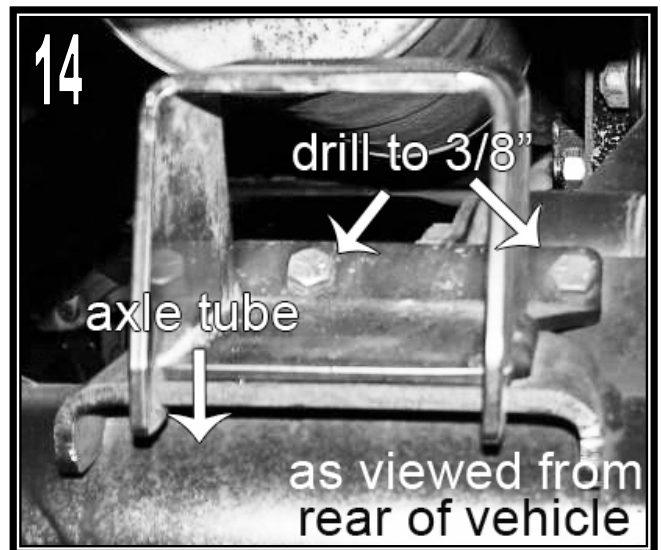
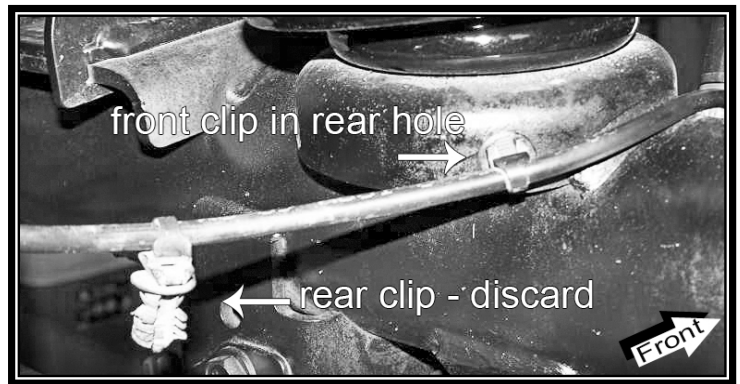
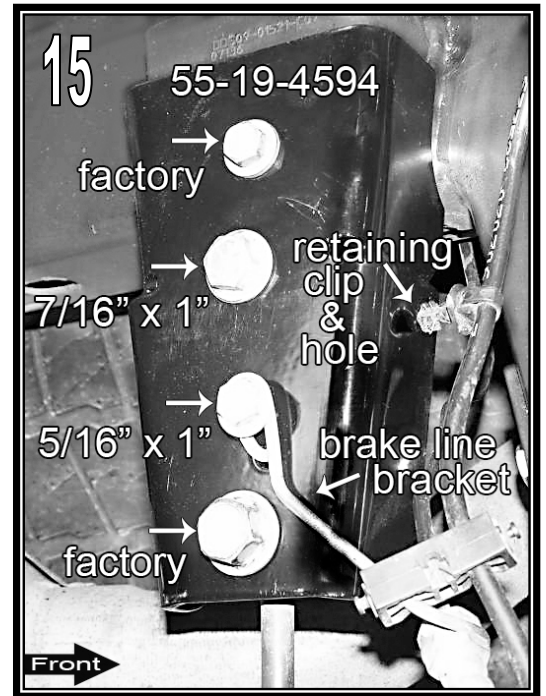

Loosely attach the upper end of the anti-sway bar link to the Superlift bracket using factory hardware. Do not tighten.

The WSS wire clip, detached in the first step, plugs into a hole in the front face of the Superlift bracket, as shown in Photo 15.

[See Photo 15] There are three more WSS wire clips per side. Lubricate all then feed the WSS wire up and along the brake hose / line so the end result is as shown.

35) TIRES / WHEELS...[See Photo 16]

Tighten the lug nuts in the sequence shown (130).

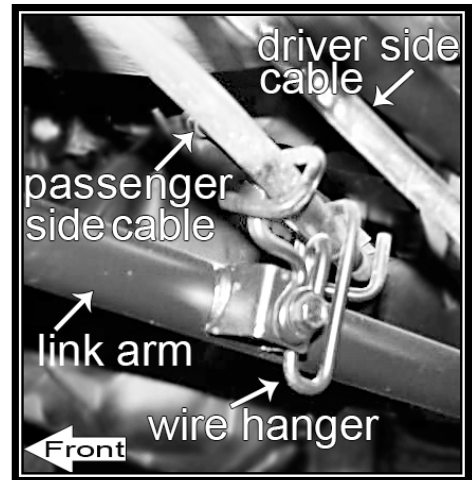

WARNING: When the tires / wheels are installed, always check for and remove any corrosion, dirt, or foreign material on the wheel-mounting surface, or anything that contacts the wheel-mounting surface (hub, rotor, etc.). Installing wheels without the proper metal-to-metal contact at the wheel mounting surfaces can cause the lug nuts to loosen and the wheel to come off while the vehicle is in motion.

WARNING: Retighten lug nuts at 500 miles after any wheel change, or anytime the lug nuts are loosened. Failure to do so could cause wheels to come off while vehicle is in motion.

Lower vehicle to the floor. The suspension is now supporting vehicle weight.

36) REAR HARDWARE TIGHTENING SEQUENCE...

Suspension link arms to frame (210). Suspension link arms to the axle (210).

Shock absorbers (100).

Reconnect upper end of track bar using the factory hardware (130). Tighten track bar's lower end (130).

Anti-sway bar links to the Superlift brackets (80).

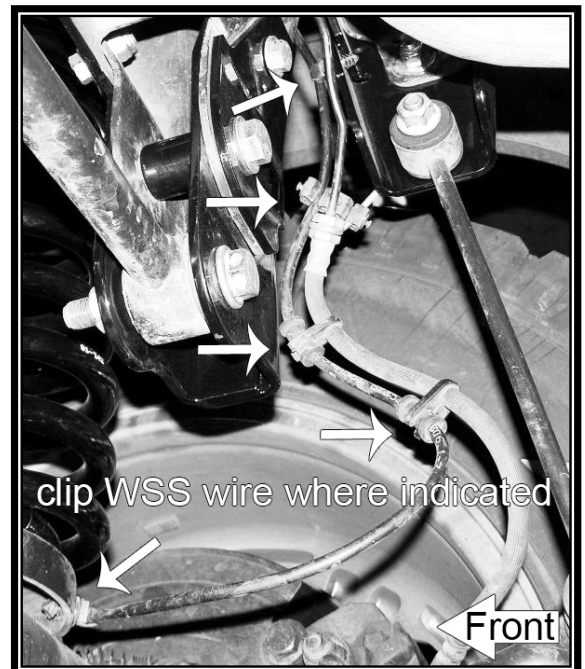

37) PARKING BRAKE CABLES...[See Photo 17]

Reattach the parking brake cables' wire hanger bracket to the driver side, lower suspension link arm, but only capture the passenger side cable; leave the driver side cable loose. Tighten the hanger bracket to the link arm bolt (35).

38) REAR WHEEL LINER...[See Photo 18] On trucks equipped with the plastic rear wheel liners the liner may have to be trimmed to minimize contact to the tire. Trim the liner horizontally on the angled face above the area of contact. Leave the two fasteners intact and trim the liner at an angle on each end to meet the bottom of the liner. Paint any exposed surfaces black for best appearance.

39) □ FINAL CLEARANCE AND TORQUE CHECK...With vehicle on floor, cycle steering lock-to-lock and inspect the tires / wheels, and the steering, suspension, and brake systems for proper operation, tightness, and adequate clearance.

40) □ FOUR WHEEL DRIVE...Activate four-wheel drive system and check for proper engagement.

41) □□ HEADLIGHTS...Readjust headlights to proper setting.

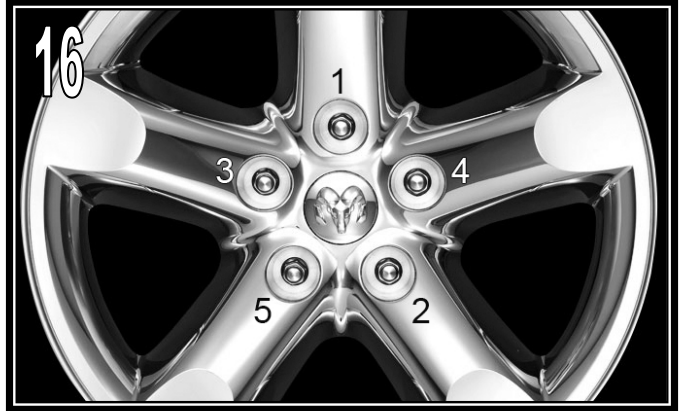

42) □ SUPERLIFT WARNING DECAL...Install the WARNING TO DRIVER decal on the inside of the windshield, or on the dash, within driver's view.

Limited Lifetime Warranty / Warnings

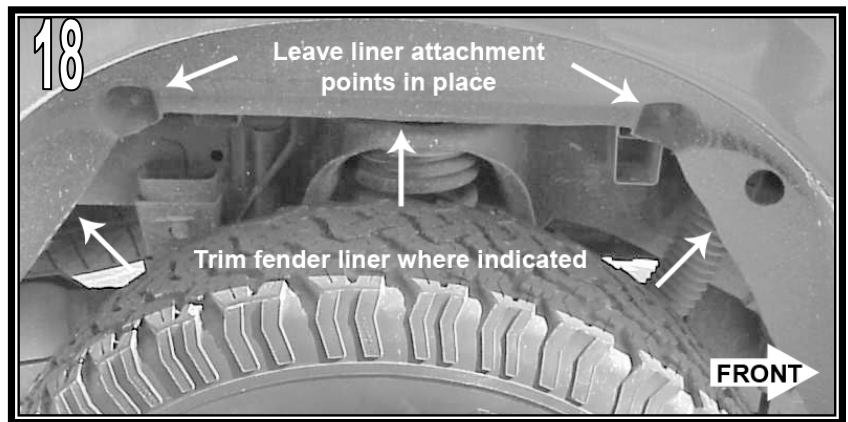

Your Superlift® product is covered by the Limited Warranty explained below that gives you specific legal rights. This limited warranty is the only warranty Superlift® makes in connection with your product purchase. Superlift® neither assumes nor authorizes any retailer or other person or entity to assume for it any other obligation or liability in connection with this product or limited warranty.

What is covered? Subject to the terms below, Superlift® will repair or replace its products found defective in materials or workmanship for so long as the original purchaser owns the vehicle on which the product was originally installed. Your warrantor is LKI Enterprises, Inc. d/b/a Superlift® Suspension Systems ("Superlift®").

What is not covered? Your Superlift® Limited Warranty does not cover products, parts or vehicles Superlift® determines to have been damaged by or subjected to:

- Alteration, modification or failure to maintain.
- Normal wear and tear (bushings, tie-rod ends, etc.). Scratches or defects in product finishes (powdercoating, plating, etc.),
- Damage to or resulting from vehicle's electronic stability system, related components or other vehicle systems.
- Racing or other vehicle competitions or contests. Accidents, impact by rocks, trees, obstacles or other aspects of the environment.
- Theft, vandalism or other intentional damage.

Remedy Limited to Repair / Replacement. The exclusive remedy provided hereunder shall, upon Superlift's inspection and at Superlift's option, be either repair or replacement of product or parts covered under this Limited Warranty. Customers requesting warranty consideration should contact Superlift® by phone (1-800-551-4955) to obtain a Returned Goods Authorization number. All removal, shipping and installation costs are customer's responsibility.

If a replacement part is needed before the Superlift® part in question can be returned, you must first purchase the replacement part. Then, if the part in question is deemed warrantable, you will be credited / refunded.

Other Limitations - Exclusion of Damages - Your Rights Under State Law

- Neither Superlift® nor your independent Superlift® dealer are responsible for any time loss, rental costs, or for any incidental, consequential or other damages you may have.
- This Limited Warranty gives you specific rights. You may also have other rights that vary from state to state. For example, while all implied warranties are disclaimed herein, any implied warranty required by law is limited to the terms of our Limited Lifetime Warranty as described above. Some states do not allow limitations of how long an implied warranty lasts and / or do not allow the exclusion or limitation of incidental or consequential damages, so the limitations and exclusions herein may not apply to you.

Important Product Use and Safety Information / Warnings

As a general rule, the taller a vehicle is, the easier it will roll over. Offset, as much as possible, what is lost in rollover resistance by increasing tire track width. In other words, go "wide" as you go "tall". Many sportsmen remove their mud tires after hunting season and install ones more appropriate for street driving; always use as wide a tire and wheel combination as feasible to enhance vehicle stability. We strongly recommend, because of rollover possibility, that the vehicle be equipped with a functional roll bar and cage system. Seat belts and shoulder harnesses should be worn at all times. Avoid situations where a side rollover may occur.

Generally, braking performance and capabilities are decreased when significantly larger / heavier tires and wheels are used. Take this into consideration while driving. Also, changing axle gear ratios or using tires that are taller or shorter than factory height will cause an erroneous speedometer reading. On vehicles equipped with an electronic speedometer, the speed signal impacts other important functions as well. Speedometer recalibration for both mechanical and electronic types is highly recommended.

Do not add, alter, or fabricate any factory or aftermarket parts to increase vehicle height over the intended height of the Superlift product purchased. Mixing component brands is not recommended.

SUPERLIFT SUSPENSION SYSTEMS

300 Huey Lenard Loop Rd.
West Monroe, Louisiana 71292
Phone: (318) 397-3000
Sales / Tech: 1-800-551-4955
FAX: (318) 397-3040
www.superlift.com