



300 HUEY LENARD LOOP | WEST MONROE | LA 71292
OFFICE: 318-397-3000 | FAX: 318-397-3040
SERVICE & TECH SUPPORT: 800-551-4955
SUPERLIFT.COM

2019-2020 RAM 1500 4WD 6" Lift Kit



⚠ CAUTION: MAKE SURE YOU HAVE THE CORRECT LIFT FOR YOUR VEHICLE:
Double check the Year, Make, Model, Lift Height and KIT Part Numbers.

Prior to beginning the installation, OPEN the boxes and CHECK the included components compared to the parts breakdown. Check all parts and hardware in the box with the parts list below. Be sure you have all needed parts and know where they install.

If you find a packaging error, contact SUPERLIFT directly. Do not contact the dealer where the system was originally purchased. You will need the control number from each box when calling; this number is located at the bottom of the part number label and to the right of the bar code.

How to Read the Kit Breakdown Charts:

The 'K KIT BREAKDOWN' lists the Part Numbers, Quantities & Part Description of the Boxes that are included in the K KIT. The 'KIT BREAKDOWN' lists Part Numbers, Quantities & Part Description of the Individual Components & Hardware Bags that are included in Each Box.

K KIT BREAKDOWN		
Kit Part Number	K198	
Part Number	Qty.	Part Description
4750	1	Kit Box: Driver Side Knuckle
4751	1	Kit Box: Passenger Side Knuckle
4752	1	Kit Box: Front and Rear Crossmembers
4753	1	Kit Box: Front Component Box
4754	1	Kit Box: Rear Component Box
84122	1	Kit Box: Rear Shocks

KIT BOX BREAKDOWN					
Kit Part Number 4750			Kit Part Number 4754		
Part Number	Qty.	Part Description	Part Number	Qty.	Part Description
66-01-4750	1	Driver Side Knuckle	55-13-4750	1	Track Bar Bracket
77-4750	1	Knuckle Hardware Bag	55-17-4750	1	Driver Link Arm Bracket
			55-18-4750	1	Passenger Link Arm Bracket
Kit Part Number 4751			55-22-4750	1	Rear Brake Line Bracket
Part Number	Qty.	Part Description	55-27-4750	1	Driver Rear Bump Stop
66-02-4750	1	Passenger Side Knuckle	55-28-4750	1	Passenger Rear Bump Stop
77-4750	1	Knuckle Hardware Bag	55-61-4594	2	Bottom Coil Spacer
			55-60-4594	2	Top Coil Spacer
Kit Part Number 4752			55-14-3310	2	Rear Sway Bar Link
Part Number	Qty.	Part Description	77-4754	1	Hardware Bag: Track Bar, Brake Line, Bump Stops
55-05-4750	1	Front Crossmember	77-4754A	1	Hardware Bag: Link Arm
55-06-4750	1	Rear Crossmember	77-4754B	1	Hardware Bag: Bushing Sleeves, Tab Bolts
77-4752	1	Crossmember Hardware Bag	77-4754C	1	Hardware Bag: Sway Bar Links, Coil Spacers
			Kit Part Number 84122		
Part Number	Qty.	Part Description	Part Number	Qty.	Part Description
55-03-4750	1	Driver Front Differential Bracket	01-88540	2	Rear Shock Absorbers
55-04-4750	1	Rear Differential Bracket	77-80026	2	Shock Bushings and Sleeves
55-07-4750	1	Passenger Front Differential Bracket			
55-09-4750	4	Strut Preload Ring			
55-10-4750	2	Strut Spacer			
55-11-4750	1	Front Driveshaft Spacer			
55-12-4750	1	Belly Pan			
55-15-4750	2	Front Sway Bar Drop			
91610	1	Front Brake Lines			
77-4753	1	Hardware Bag: Differential Brackets			
77-4753A	1	Hardware Bag: Strut, Driveshaft, Belly Pan, Sway Bar			



THANK YOU FOR CHOOSING SUPERLIFT FOR ALL YOUR SUSPENSION NEEDS!!

Read And Understand All Instructions And Warnings Prior To Installation Of System AND Operation Of Vehicle.

INTRODUCTION BEFORE INSTALLATION...

Installation requires a professional mechanic. In addition to these instructions, professional knowledge of disassembly / reassembly procedures and post installation checks must be known.

PRIOR to beginning, inspect the vehicles steering, driveline, and brake systems, paying close attention to the suspension link arms and bushings, sway bars and bushings, tie rod ends, pitman arm, idler arm, ball joints and wheel bearings. Also check the steering sector-to-frame and all suspension-to-frame attaching points for stress cracks. The overall vehicle must be in excellent working condition; repair or replace all worn parts.

Read instructions several times before starting.

Read each step completely as you go.

Be sure you have all needed parts and know where they install...

⚠ NOTES:

- DOES NOT fit TRX or models equipped with air ride suspensions.
- Stock factory 17" and 18" wheels will NOT fit back on the vehicle once this suspension system is installed.
- Do NOT install this suspension system in conjunction with any other type of aftermarket or fabricated components to gain additional suspension height.
- Do not fabricate any components to gain additional suspension height.
- Prior to drilling and/or cutting, check behind the surface being worked on for any wires, lines, or hoses that could be damaged. Prep all cutting surfaces by removing all debris and frame coatings.
- After drilling and/or cutting, file smooth any burrs and sharp edges.
- Prior to operating a torch or saw, protect any heat-sensitive components located in the immediate area by covering them with a water-saturated cloth. Most undercoating are flammable but can be extinguished using a water-filled spray bottle. Have a spray bottle and an ABC rated fire extinguisher on hand.
- Paint or undercoat all exposed metal surfaces.
- Prior to attaching components, be sure all mating surfaces are free of grit, grime, grease, undercoating, etc.
- Front end alignment is necessary.
- Tool and Wrench/Socket size is given in brackets [] after each appropriate step.
- A foot-pound torque reading is given in parenthesis () after each appropriate fastener.
- Always wear safety glasses when using power tools.
- A factory service manual should be on hand for reference.
- Due to payload options and initial ride height variances, the amount of lift is a 'base figure'. Final ride height dimensions may vary in accordance to original vehicle stance.

BEFORE YOU DRIVE...

Check all fasteners for proper torque. Check to ensure for adequate clearance between all rotating, mobile, fixed, and heated members. Verify clearance between exhaust and brake lines, fuel lines, fuel tank, floor

boards and wiring harness. Check steering components for clearance.

Test and inspect brake system. Perform steering sweep to ensure front brake hoses have adequate slack and do not contact any rotating, mobile or heated members. Inspect rear brake hoses at full extension for adequate slack. Failure to perform hose check/replacement may result in component failure.

Perform head light check and adjustment.

⚠️ WARNING: It is the ultimate buyer's responsibility to have all bolts / nuts checked for tightness after the first 100 miles and then every 1000 miles. The steering, suspension and driveline systems, plus wheel alignment should be inspected by a qualified professional mechanic at least every 3000 miles.

TIRES & WHEELS...

Larger rim and tire combinations may increase leverage on suspension, steering, and related components. When selecting combinations larger than OE, consider the additional stress you could be inducing on the OE and related components.

ANY larger or wider tire & wheel combination other than listed will require vehicle trimming.

⚠️ NOTE: ALL tire & wheel combinations should be test fit prior to installation. Some minor trimming may be required. This is normal with most aftermarket tire/wheel fitments on today's trucks. Trimming will normally include the bottom edge of the inner fender shrouds and/or lower corner of front bumper valance. As a rule of thumb, deeper backspacing and shorter/narrower tires will reduce/eliminate trimming required.

TIRE SIZE SPECIFICATIONS		
Tire Size	Wheel	Offset (mm)
37x12.50 R20	20x9	0 to -12
37x12.50 R20	20x10	-18 to -24
37x12.50 R22	22x10	-18 to -24

TORQUE SPECIFICATIONS					
Standard			Metric		
Size	Grade 5	Grade 8	Size	Grade 8.8	Grade 10.9
5/16"	15 ft/lbs.	20 ft/lbs.	6mm	7 ft/lbs.	10 ft/lbs.
3/8"	30 ft/lbs.	35 ft/lbs.	8mm	17 ft/lbs.	24 ft/lbs.
7/16"	45 ft/lbs.	60 ft/lbs.	10mm	33 ft/lbs.	47 ft/lbs.
1/2"	65 ft/lbs.	90 ft/lbs.	12mm	59 ft/lbs.	83 ft/lbs.
9/16"	95 ft/lbs.	130 ft/lbs.	14mm	101 ft/lbs.	131 ft/lbs.
5/8"	135 ft/lbs.	175 ft/lbs.	16mm	146 ft/lbs.	202 ft/lbs.
3/4"	185 ft/lbs.	280 ft/lbs.	18mm	201 ft/lbs.	283 ft/lbs.

STEP	PART NUMBER	QTY. PER KIT	DESCRIPTION	NEW ATTACHING HARDWARE	QTY. PER BRACKET	HARDWARE BAG NUMBER
79	66-01-4750	1	Driver Side Knuckle	1/4" x 3/4" Bolt, Coarse Thread	1	77-4750
				1/4" Adel Clamp	1	
79	66-02-4750	1	Passenger Side Knuckle	1/4" x 3/4" Bolt, Coarse Thread	1	77-4750
				1/4" Adel Clamp	1	
36	55-03-4750	1	Driver Front Differential Bracket	12mm x 40mm Bolt, 1.75 Pitch	2	77-4753
				12mm Flat Washer	2	
				1/2" x 2" Bolt, Coarse Thread	2	
				1/2" Nyloc Nut, Coarse Thread	2	
				1/2" SAE Washer	4	
38	55-04-4750	1	Rear Differential Bracket	1/2" x 1-1/2" Bolt, Coarse Thread	3	77-4753
				1/2" Nyloc Nut, Coarse Thread	3	
				1/2" SAE Washer	3	
54	55-05-4750	1	Front Crossmember	55-21-4750 - Lockout Washer	4	77-4752
				18mm x 140mm Bolt, Pitch 2.5	2	
				18mm Nyloc Nut, Pitch 2.5	2	
53	55-06-4750	1	Rear Crossmember	55-21-4750 - Lockout Washer	4	77-4752
				18mm x 140mm Bolt, Pitch 2.5	2	
				18mm Nyloc Nut, Pitch 2.5	2	
39	55-07-4750	1	Passenger Front Differential Bracket	12mm x 70mm Bolt, Pitch 1.75	2	77-4753
				12mm Flat Washer	4	
				12mm Nyloc Nut	2	
				1/2" x 2-1/4" Bolt, Coarse Thread	2	
				1/2" Nyloc Nut, Coarse Thread	2	
				1/2" SAE Washer	4	
63	55-09-4750	4	Strut Preload Ring			
72	55-10-4750	2	Strut Spacer	10mm x 35mm Carriage Bolt, Pitch 1.5	6	77-4753A
				10mm Push Nut	6	
				10mm Flange Nut, Pitch 1.5		
52	55-11-4750	1	Front Driveshaft Spacer	12mm x 60mm Bolt, Pitch 1.75	4	77-4753A
				12mm Flat Washer	4	
102	55-12-4750	1	Belly Pan	3/8" x 1" Bolt, Coarse Thread	4	77-4753A
				3/8" Flange Nut, Coarse Thread	4	
24	55-13-4750	1	Track Bar Bracket	1/2" x 1-1/4" Bolt, Coarse Thread	2	77-4754
				1/2" Flange Nut, Coarse Thread	2	
				1/2" SAE Washer	2	
				9/16" x 3" Bolt, Coarse Thread	1	
				9/16" SAE Washer	2	
				9/16" Nyloc Nut, Coarse Thread	1	
				5/16" x 1-1/4" Bolt, Coarse Thread	1	
				5/16" Flange Nut, Coarse Thread	1	
				5/16" SAE Washer	2	
99	55-15-4750	2	Front Sway Bar Bracket	7/16" x 1-1/4" Bolt, Coarse Thread	4	77-4753A
				7/16" Nyloc Nut, Coarse Thread	4	
				7/16" SAE Washer	8	
19	55-17-4750	1	Driver Link Arm Bracket	5/8" x 4-1/2" Bolt, Coarse Thread	2	77-4754A
				5/8" Nyloc Nut, Coarse Thread	2	
				5/8" SAE Washer	4	
				1/2" x 1-1/2" Bolt, Coarse Thread	1	
				1/2" SAE Washer	1	
77-4754B	55-10-5070 - Tab Nut	1				
19	55-18-4750	1	Passenger Link Arm Bracket	5/8" x 4-1/2" Bolt, Coarse Thread	2	77-4754A
				5/8" Nyloc Nut, Coarse Thread	2	
				5/8" SAE Washer	4	
				1/2" x 1-1/2" Bolt, Coarse Thread	1	
				1/2" SAE Washer	1	
77-4754B	55-10-5070 - Tab Nut	1				
35	55-22-4750	1	Rear Brakeline Bracket	5/16" x 1" Bolt, Coarse Thread	1	77-4754
				5/16" Nyloc Nut, Coarse Thread	1	
				5/16" SAE Washer	2	
23	55-27-4750	1	Driver Rear Bump Stop Bracket	3/8" x 1" Bolt, Coarse Thread	2	77-4754
				3/8" Flange Nut, Coarse Thread	2	
				3/8" SAE Washer	2	
23	55-28-4750	1	Passenger Rear Bump Stop Bracket	3/8" x 1" Bolt, Coarse Thread	2	77-4754
				3/8" Flange Nut, Coarse Thread	2	
				3/8" SAE Washer	2	
38	55-14-3310	2	Rear Sway Bar Link	01-60454 - Sleeve	1	77-4754B
				01-60450 - Sleeve	1	
				01-60416 - Bushing	2	
				1/2" x 2-3/4" Bolt, Coarse Thread	1	77-4754C
				1/2" Nyloc Nut, Coarse Thread	1	
				1/2" USS Washer	1	
32	01-88540	2	Rear Shock Absorber	02-2210 - Sleeve	2	77-80026
				142731 - Washer Pack	2	
				01-60419 - Bushings	2	
88	01-91610	2	Front Brakelines			
28	55-60-4594 55-61-4594	2	Top Coil Spacer Bottom Coil Spacer	7/16" x 1-1/4" Carriage Bolt, Coarse Thread	4	77-4754C
				7/16" Flange Nut, Coarse Thread	4	
				5/16" x 1" Bolt, Coarse Thread	3	
				5/16" Flange Nut, Coarse Thread	3	
				5/16" Push Nut	3	

FRONT DISASSEMBLY AND INSTALLATION

Save ALL factory components and hardware for reuse, unless noted.

PREPARE VEHICLE FOR FRONT INSTALLATION

1. Disconnect the battery.
2. Chock rear tires and place transmission in neutral.
3. Raise the front of vehicle with a jack and secure a jack stand beneath each frame rail.
4. Ease the frame down onto the stands, place transmission in park for automatic.
5. Remove the front wheels & tires. [22mm]
6. [Illustration 1] Remove the four bolts retaining the factory skid plate and discard. [16mm]
7. [Illustration 2] Loosen but do not remove the upper control arm bolts at the frame. [21mm]

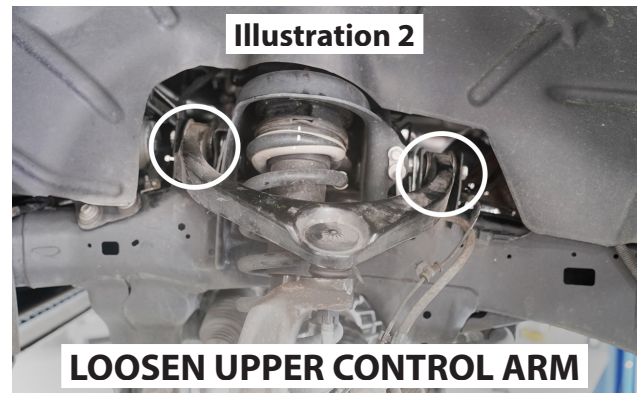

SWAY BAR

8. [Illustration 3] Disconnect the sway bar links from the lower control arm on both sides. [18mm]
9. [Illustration 4] Remove two bolts attaching the sway bar to the frame on both sides. [15mm]
10. [Illustration 5] Remove the sway bar from the vehicle.

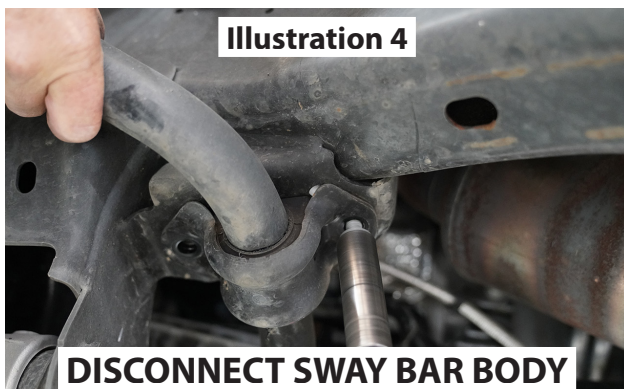

KNUCKLE

11. [Illustration 6] Using the appropriate puller tool, disconnect the tie rod end from the knuckle. [21mm]
If you do not have a puller tool you can use a hammer by very carefully striking the ball joint boss of the knuckle; do not strike the tie rod.

12. [Illustration 7] Unclip ABS wire from brake hose.

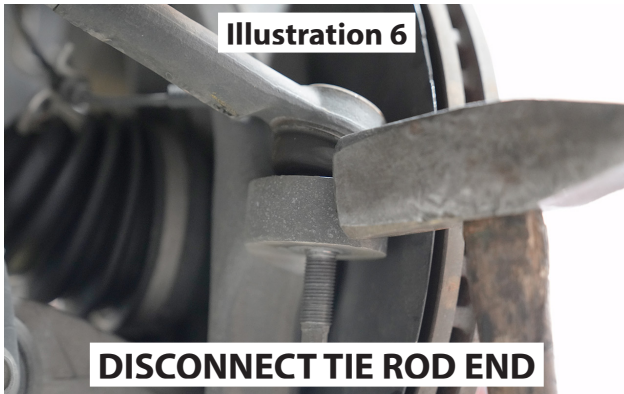

13. [Illustration 8] Remove the caliper mounting bolts and hang the caliper out of the way. [21mm] NOTE: DO NOT LET THE CALIPER HANG FROM BRAKE HOSE.

14. [Illustration 9] Remove the brake rotor. [T30 torx]

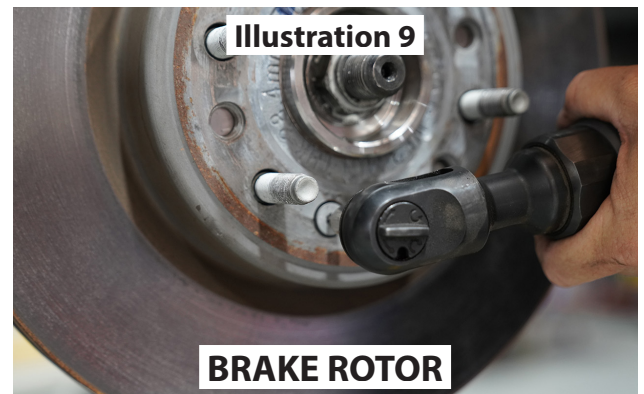
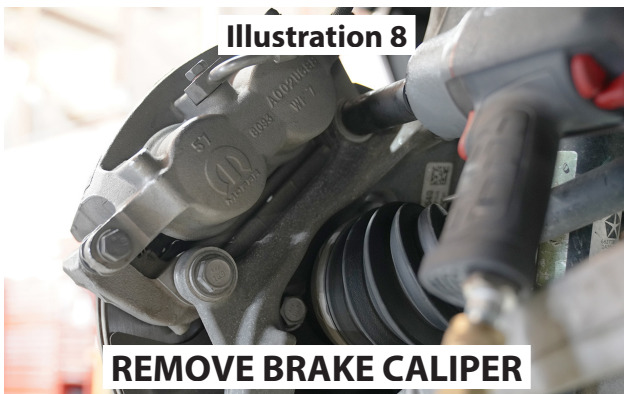

15. [Illustration 10 & 11] Disconnect the ABS sensor from the hub and unclip the ABS wire from the knuckle and the upper control arm. [5mm]

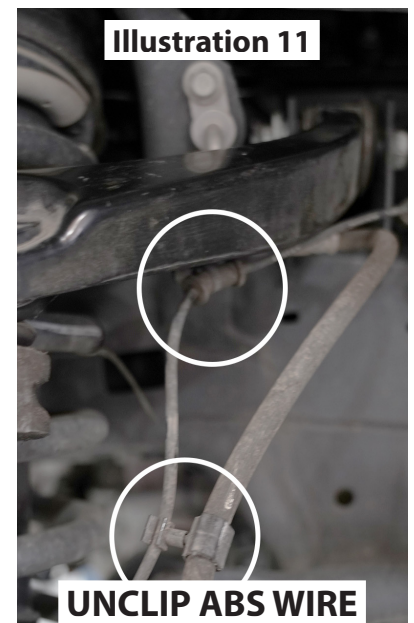
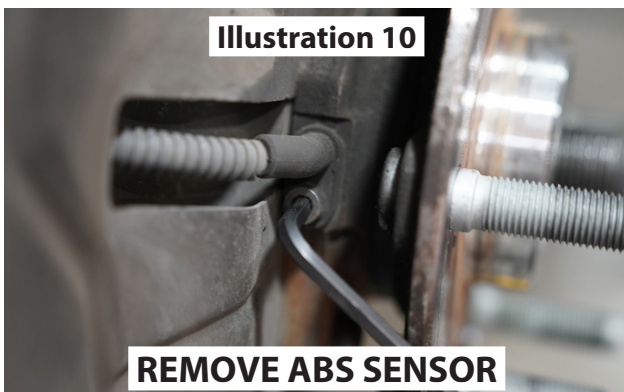

16. [Illustration 12] Remove the CV axle retaining nut. [36mm]

17. [Illustration 13] Disconnect the upper control arm ball joint from the knuckle. [21mm]

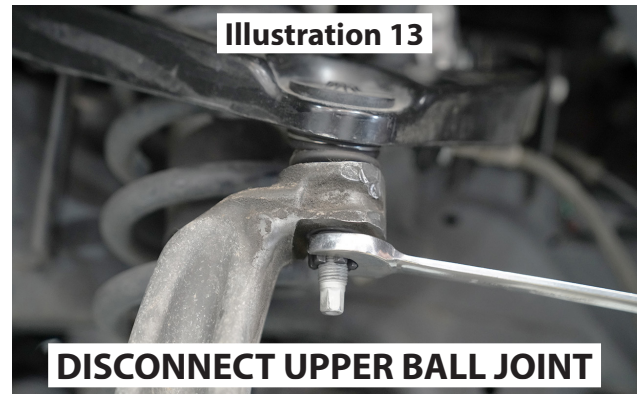

18. [Illustration 14 & 15] Disconnect the lower control arm ball joint from the knuckle and remove the knuckle from the vehicle. [24mm]

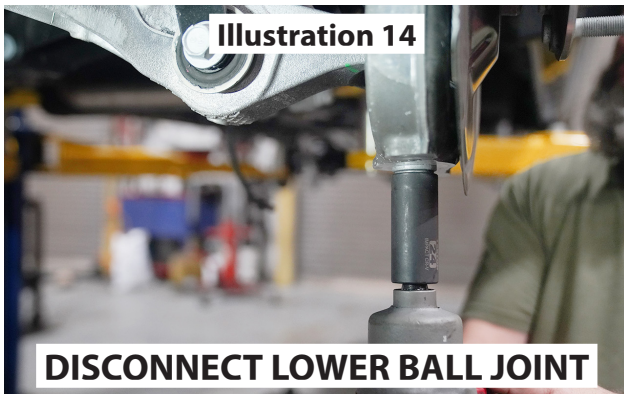

LOWER CONTROL ARM

19. [Illustration 16] Loosen the lower control arm mounting bolts. [24mm]

20. [Illustration 17] Remove the lower strut bolt. [21mm, 24mm]

21. [Illustration 18] Remove the lower control arm bolts then remove lower control arm from vehicle.

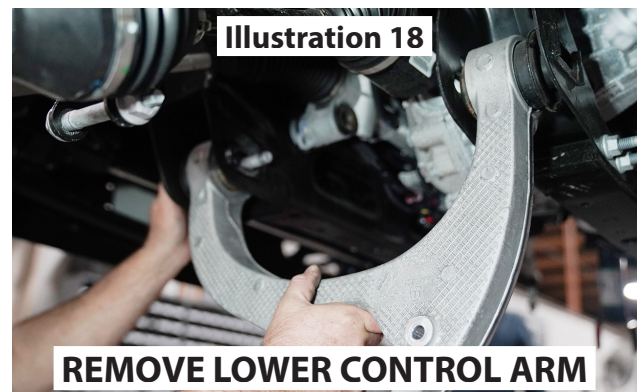
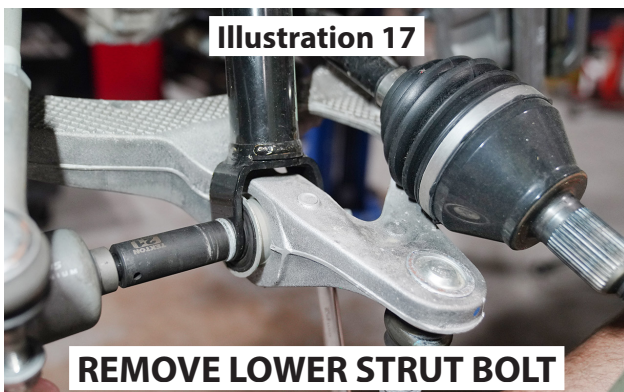
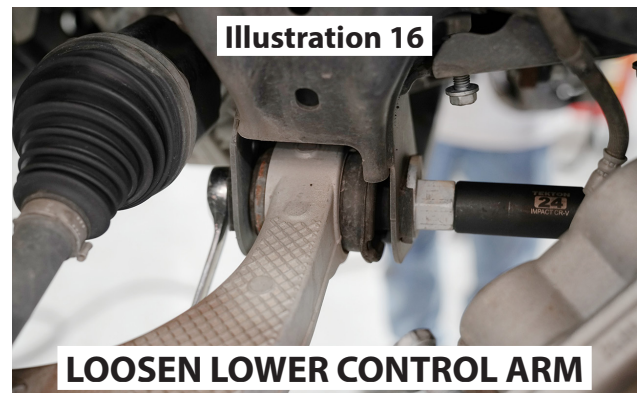

STRUT

22. [Illustration 19] Remove the upper strut nuts then remove strut from vehicle. [16mm]

**DIFFERENTIAL REMOVAL**

23. [Illustration 20] Remove the factory rear crossmember. [18mm]

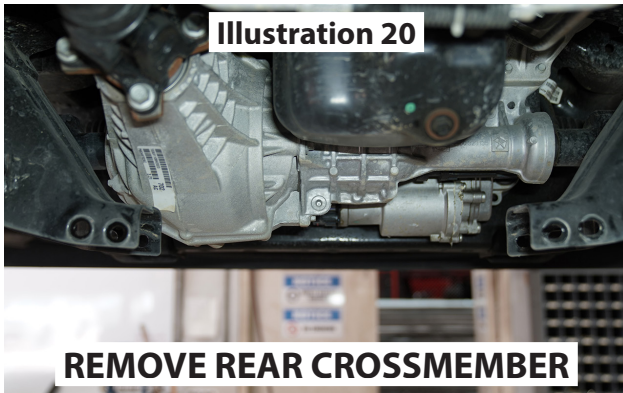

24. [Illustration 21] Mark the driveshaft location on the driveshaft and the mounting flange on the differential.



25. [Illustration 21] Disconnect the driveshaft from the differential and secure it up and out of the way. [15mm]

26. [Illustration 22] Disconnect all the electrical plugs from the differential. NOTE: Most of the plugs have a "locking tab" that must be pulled back before the plug will separate.

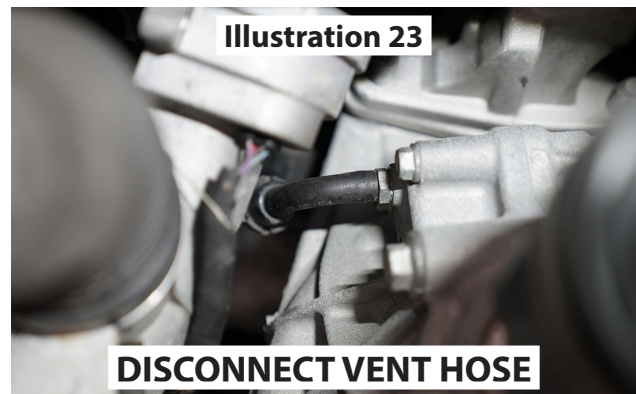

27. [Illustration 23] Disconnect the vent hose from the differential.

28. [Illustration 24] Support the differential and remove the front driver side differential bolt. [18mm] NOTE: The wiring harness may need to be unclipped from the oil pan and moved upward to allow access to the rearward bolt.

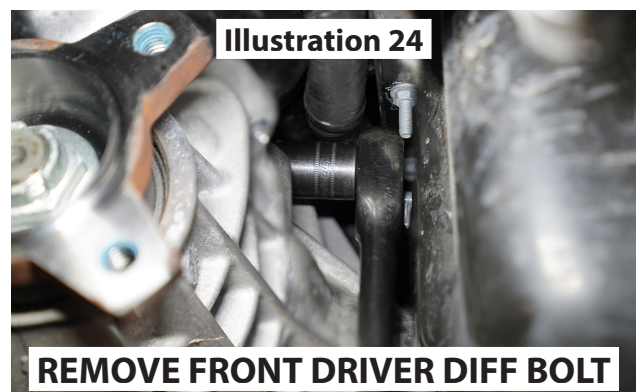

29. [Illustration 25] Remove the three bolts on the driver rear differential mount. [18mm]

30. [Illustration 26] Remove the two bolts on the passenger side differential mount. [18mm]

31. [Illustration 27] Lower the differential and remove from the vehicle.

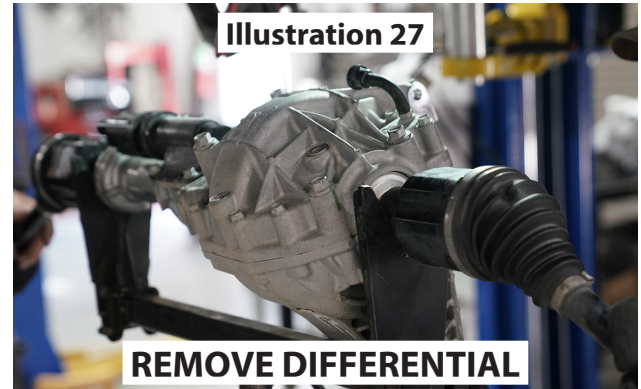
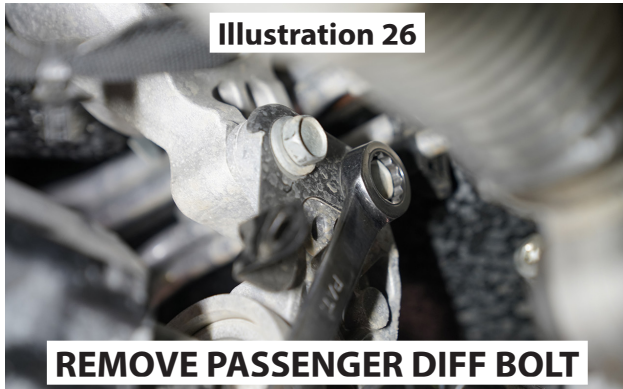
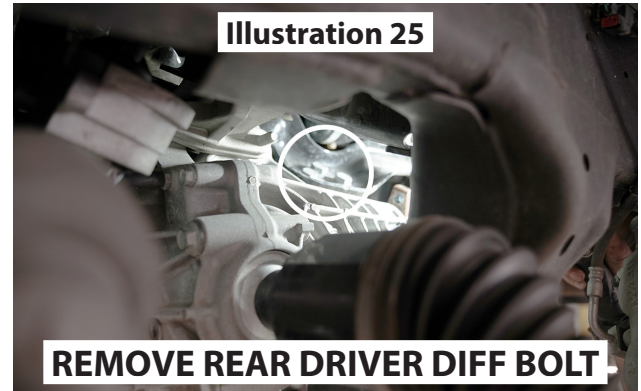

CUTTING FRAME

32. [Illustration 28] Measure 2-3/4" from inside edge of the factory rear crossmember on the front and rear of the lower control arm pocket and mark. Connect marks across the top. Do this on both driver and passenger sides.

33. [Illustration 28] From the bottom edge of the cam bolt plate, measure down 1" on the front and rear of the lower control arm pocket and mark a line parallel with the slot.

34. [Illustration 29] Cut the control arm pockets along the marks.

35. [Illustration 29] Grind and paint all the exposed areas.

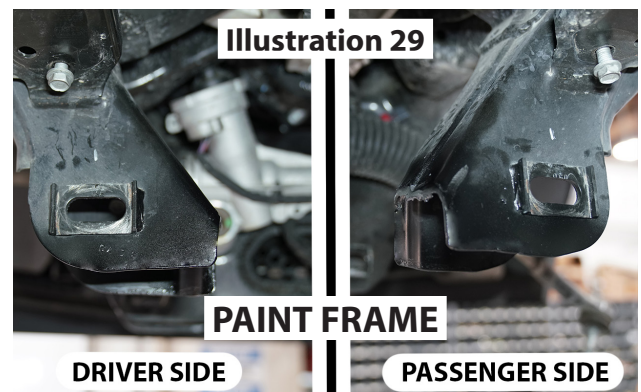
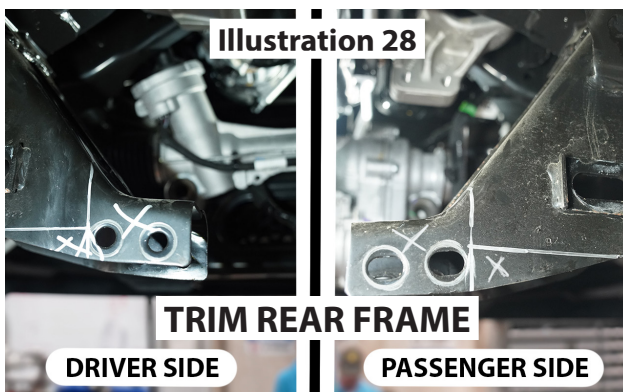

DIFFERENTIAL INSTALLATION

36. [Illustration 30] Install the new driver front differential bracket (55-03-4750) to the frame using the supplied 12mm x 40mm bolts and washers. [19mm] (50) NOTE: The bracket has an arrow that is cut into the bracket that goes to the top and points forward.

37. If the wire loom was removed, reattach to the oil pan at this time.

38. [Illustration 31] Install the new driver rear differential bracket (55-04-4750) to the frame using the supplied 1/2" x 1-1/2" bolts, washers and nyloc nuts. [3/4"] Snug but do not tighten.

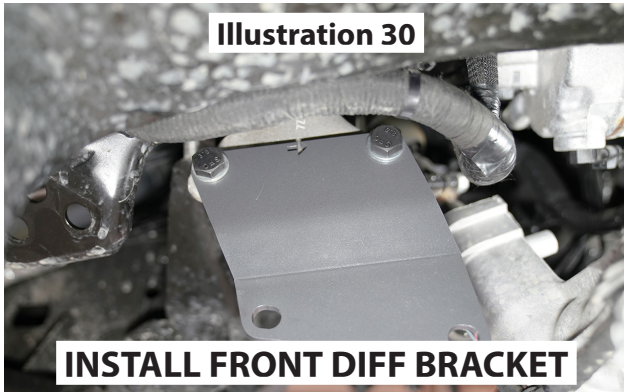

39. [Illustration 32] Install the passenger differential bracket (55-07-4750) to the frame using the supplied 12mm x 70mm, washers, and nyloc nuts; tighten. [19mm] (50) NOTE: Position the bracket so that the offset is towards the front of the vehicle.

40. [Illustration 33] Drill the factory wiring harness bracket holes to 1/2".



41. [Illustration 34] Install the differential and attach to the passenger side bracket with the wiring harness bracket positioned on the front of the differential using the supplied 1/2" x 2" bolts, washers, and nyloc nuts. [3/4"] Do not tighten at this time. NOTE: Bolts go in from front through wiring harness bracket, differential, then Superlift bracket, washer, and nut.

42. [Illustration 35] Attach the differential to the driver front bracket using the supplied 1/2" x 2" bolts, washers, and nyloc nuts. [3/4"] Do not tighten at this time.

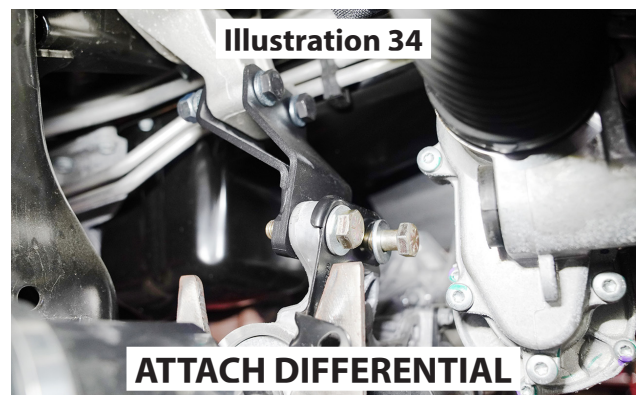

43. [Illustration 35] Attach the differential to the driver rear bracket using the factory hardware. [18mm] Do not tighten at this time.

44. [Illustration 35] Tighten the driver rear differential bracket at the frame. [3/4"] (65)

45. [Illustration 36] Tighten the driver front differential bracket at the differential. [3/4"] (65)

46. [Illustration 35] Tighten the driver rear differential bracket at the differential. [18mm] (50)

47. [Illustration 37] Tighten the passenger differential bracket at the differential. [3/4"] (65) NOTE: The bolts must be tightened before the nuts.

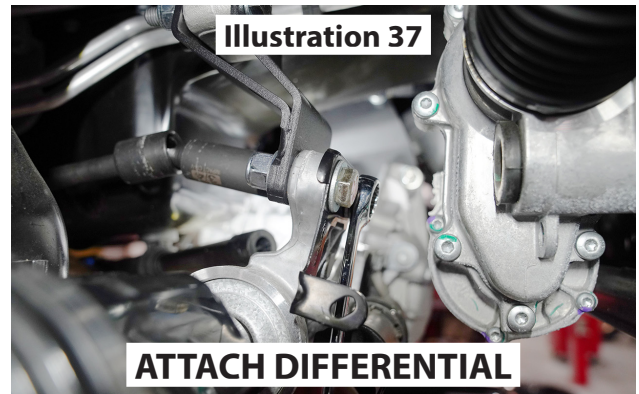
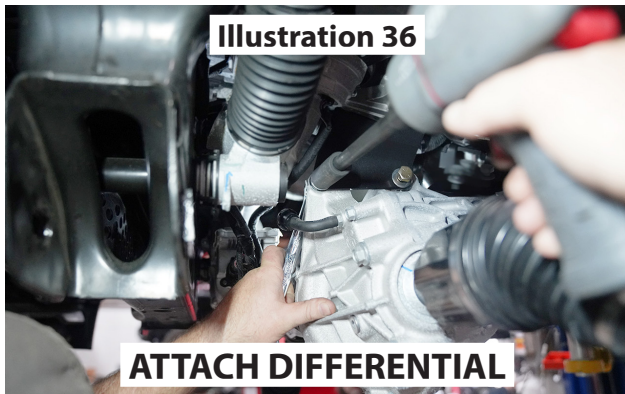
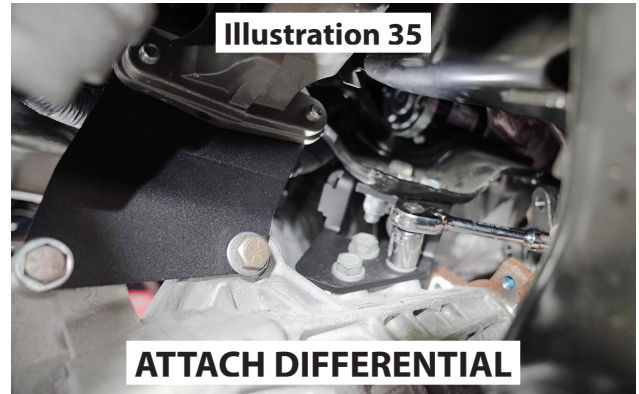

48. [Illustration 38] Unclip the differential wiring harness from the frame (2 clips). Plug into differential and attach the lower clip to the wiring harness bracket.

49. Install the new 5/16" vacuum hose adapter (23-3205) and the new vacuum hose (18-9690) to the factory vacuum hose.

50. [Illustration 39 & 40] Reconnect all the electrical plugs to the differential.

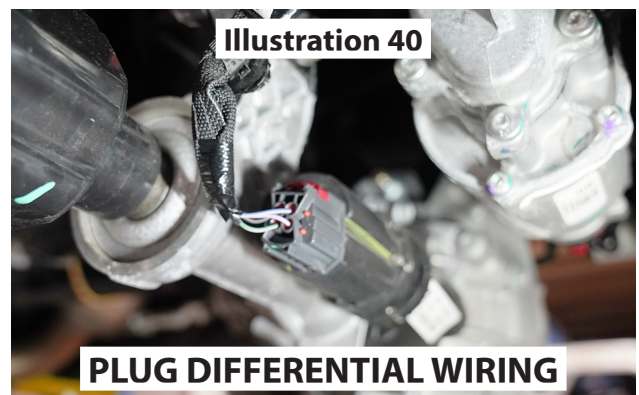

51. [Illustration 41] The shifter linkage shield must be trimmed to allow clearance for the driveshaft. Mark a straight line from the curved area to the end of the shield, then cut.

52. [Illustration 42] Align the marks previously made during removal and install the new driveshaft spacer (55-11-4750) between the differential and the factory driveshaft using the supplied 12mm x 60mm bolts and washers. Apply supplied thread locker before installing bolts. [19mm] (55)

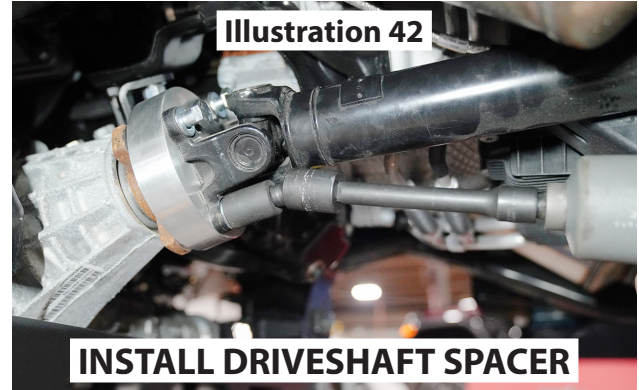

CROSSMEMBERS

53. [Illustration 43] Install the new rear crossmember (55-06-4750) to the frame using the supplied 18mm x 140mm bolts, new lockout washers, and nyloc nuts. [27mm] Bolts are installed from the rear to front. Do not tighten at this time.

54. [Illustration 44] Install the new front crossmember (55-05-4750) to the frame using the supplied 18mm x 140mm bolts, new lockout washers (55-21-4750), and nyloc nuts. [27mm] Bolts installed from front to rear. Do not tighten at this time.

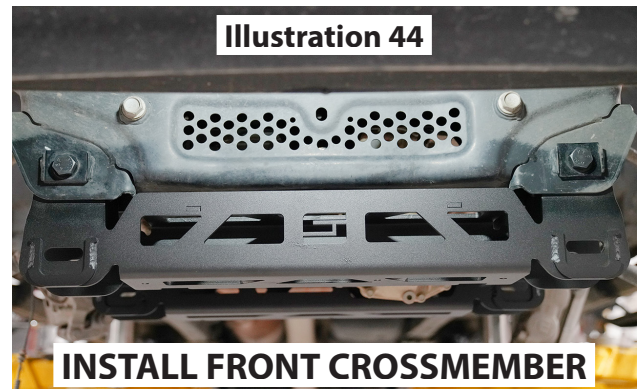

55. [Illustration 45] Install the lower control arms into the new crossmembers using the factory cam bolt hardware. NOTE: Front crossmember bolts are installed from front and the rear crossmember bolts are installed from the back.

56. [Illustration 45] Position the cams so the lobes are in the upright neutral position and snug. [24mm] Do not tighten.

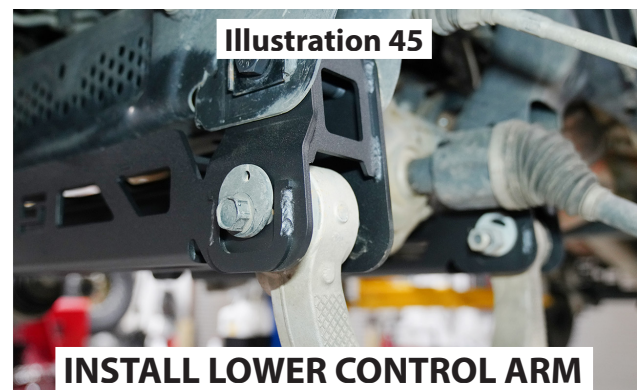

STRUT

57. [Illustration 46] On the strut assembly mark the orientation of the upper mounting plate, the coil springs, and the lower strut mount.

58. [Illustration 46] Using the appropriate coil compressor, compress the coil until the strut body has approximately 3/8" of movement and remove the upper strut mounting plate retaining nut. [18mm, 8mm]

NOTE: Do not use an impact to remove the nut.

59. [Illustration 46] Remove the washer, upper bushing half, the upper mounting plate, and the coil spring isolator.

60. Remove the strut body from the coil spring. NOTE: Inspect the strut assembly for damage or fluid leakage; replace if necessary.

NOTE: If replacement Bilstein struts were purchased skip to step (66).

61. Position the strut cylinder back into the compressed spring making sure to align the indexing marks on the lower strut mount and the coil spring.

62. Position the spring isolator on the top of the coil spring.

63. [Illustration 47] Position the two new coil spring preload spacers (55-09-4750) on the top of the isolator.

64. Position the strut upper mounting plate on the top of the new spacer, aligning the plate indexing mark with the marks on the coil spring and strut body.

65. Install the factory bushing half, washer, and nut; tighten. [18mm, 8mm] (20)

NOTE: If replacement Bilstein struts were not purchased skip to step (72).

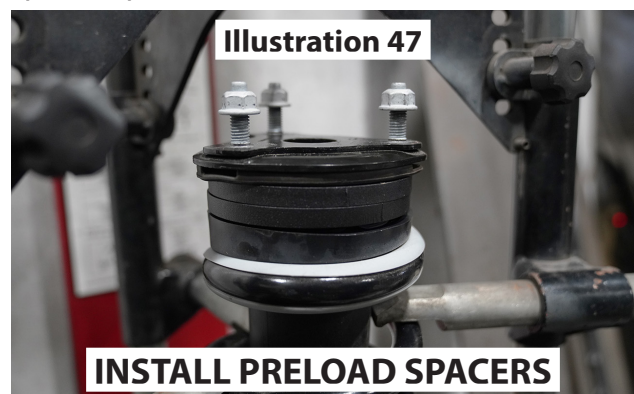

REPLACEMENT STRUTS

66. [Illustration 48] With the factory strut removed, slide the rubber snubber from the shaft, stand the strut up on the shaft end and carefully remove the strut end cap, then remove the lower coil seat.

67. [Illustration 49] Position the snap ring on the new strut in the end groove closest to the shaft, then slide the lower seat collar onto the snap ring. The collar may need to be carefully tapped in place with a hammer.

68. [Illustration 49] Slide the lower coil seat onto the collar and tap into place.

69. [Illustration 49] Place the machined spacer on the body followed by the lower coil seat.

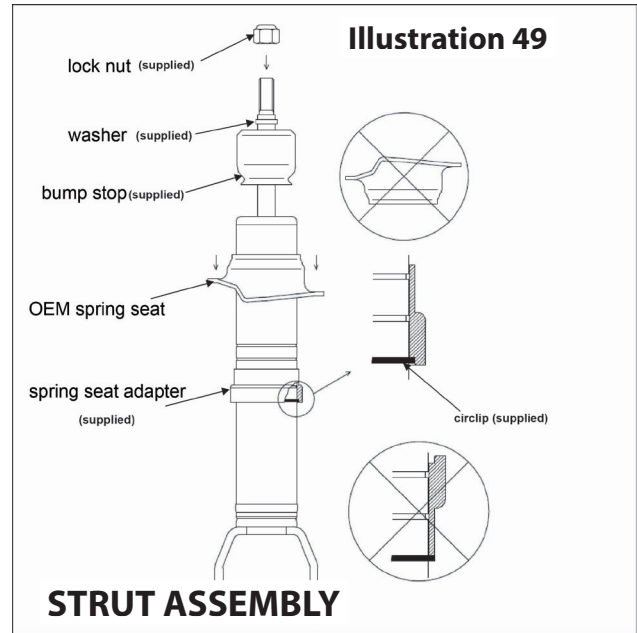

70. Install the shock inside the coil and rotate the coil until the coil is seated properly in the lower coil seat and tighten the factory nut. [16mm] (45)

71. Slowly decompress the coil spring on the strut assembly while ensuring that the coil spring remains seated correctly in its lower seat and that all three index marks remaining aligned.

72. [Illustration 50] Attach the supplied 10mm carriage bolts to the new strut spacer (55-10-4750) using the push nuts. The carriage bolts must be placed into the end of the spacer with square holes.

73. [Illustration 50] Position the strut spacer on the top of the factory strut using the factory hardware and tighten. (45)

74. [Illustration 51] Install the strut assembly by first loosely attaching the strut's upper studs to the factory frame mount using the supplied 10mm flange nuts. [15mm] Do not tighten.

75. [Illustration 52] Raise the lower control arm and attach the strut using the factory hardware. [21mm, 24mm] Do not tighten at this time.

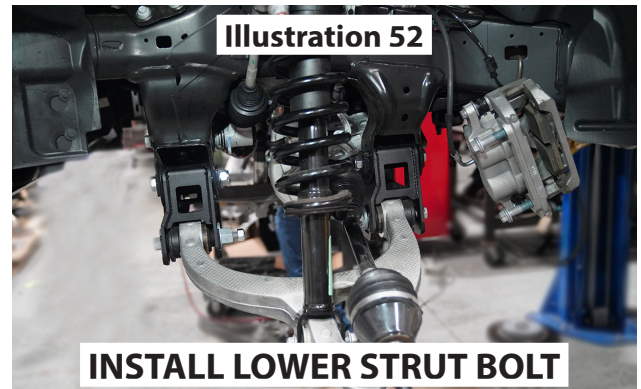

76. [Illustration 51] Tighten the upper strut hardware. [15mm] (30)

77. [Illustration 52] Tighten the crossmember bolts at the frame. [27mm] (220)

KNUCKLE and BRAKE HOSE

78. [Illustration 54] Remove the hub assembly and dust shield from the factory knuckle. [21mm] (95)

79. [Illustration 55] Position the factory hub assembly and dust shield onto the new knuckle (driver side = 66-01-4750 / passenger side = 66-02-4750). The hub must be positioned with the WSS wire routed forward and inside the relief machined into the knuckle face.

80. Apply thread locker to the factory hardware and fasten the hub assembly to the knuckle. [21mm] (95)

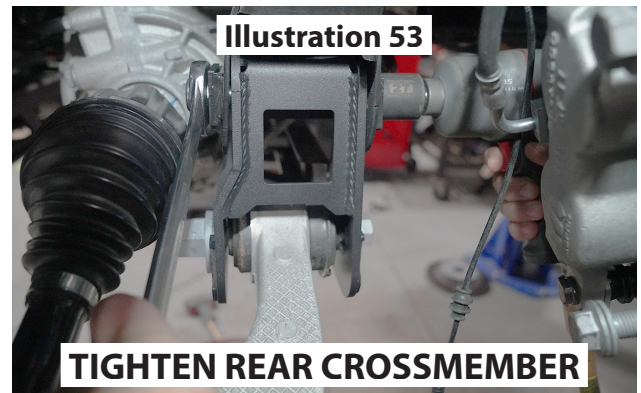

81. [Illustration 56] Install the new knuckle assembly in the vehicle. Attach the lower ball joint first then slide the CV axle shaft through the hub bearing.

82. [Illustration 57] Connect the upper ball joint using factory hardware.

83. [Illustration 58 & 59] Unclip the ABS wire from the frame at two locations and feed the wire down to the knuckle; routing the wire behind the knuckle and over the tie rod boss between the knuckle and the dust shield.



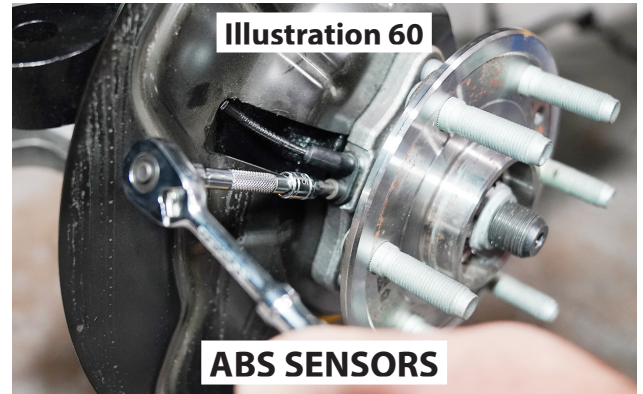
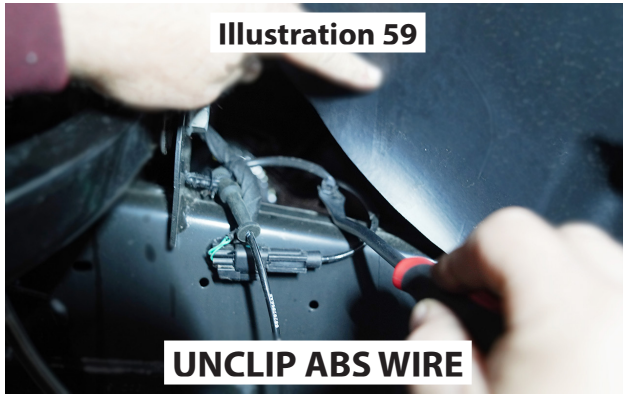

84. [Illustration 60] Attach the ABS sensor to the knuckle. [5mm allen] (7)

85. Install the brake rotor. [T30] (20)

86. [Illustration 61] Install the brake caliper using the factory hardware and supplied thread locker. [21mm] (130)

87. [Illustration 62 & 63] Using a clamp or vice grips, clamp the factory brake hose and then unbolt the hose from the caliper. [15mm]

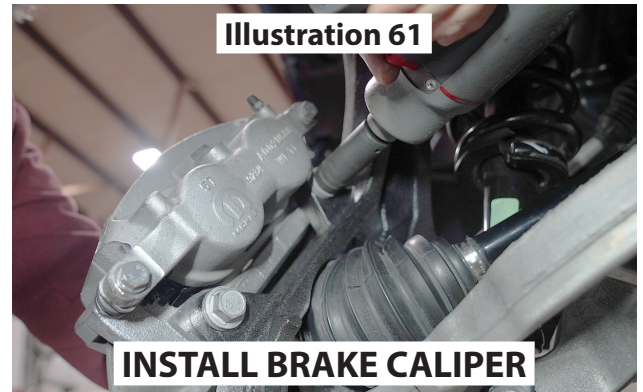

88. [Illustration 64 & 65] Install the new brake hose (driver side = 01-91610 / passenger side 02-91610) to the brake caliper using the factory bolt and two supplied crush washers. NOTE: A crush washer must be placed on each side of the brake hose "block" that is bolted to the caliper.

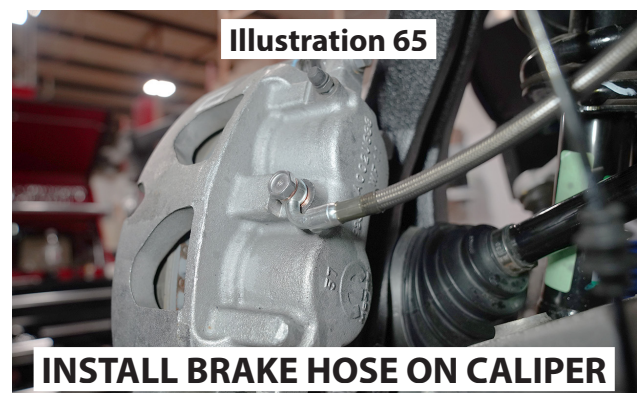

89. [Illustration 66] Unbolt the brake hose from the metal brake line at the frame. [12mm line wrench /flare nut wrench] NOTE: These nuts are easily stripped so be extremely careful.

90. [Illustration 66] Unbolt the brake hose from the frame. [13mm]

91. [Illustration 67] Insert the new brake hose through the factory brake hose frame location and attach to the brake line. [12mm line wrench / flare nut wrench] NOTE: Take caution to not over tighten as these are very easily stripped.

92. [Illustration 67] Attach the new brake hose to the frame using the supplied horseshoe clip by clipping it onto the hose on the inside of the frame mount.

93. [Illustration 68] Install the supplied adel clamp over the brake hose and the abs wire and attach to the knuckle with the supplied 1/4" x 3/4" hardware. [7/16"] (45)

94. Route the ABS wire and reattach the factory plastic clips to the outside of the frame.

95. [Illustration 69] Connect the tie rod to the knuckle using factory hardware and tighten. [21mm] (85)

96. [Illustration 70] Tighten the lower ball joint nut. [24mm] (65)

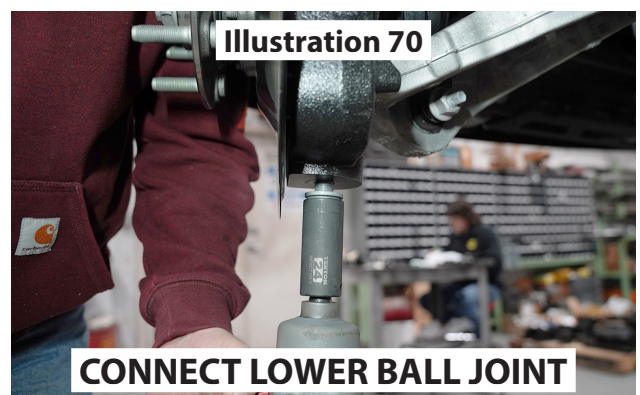
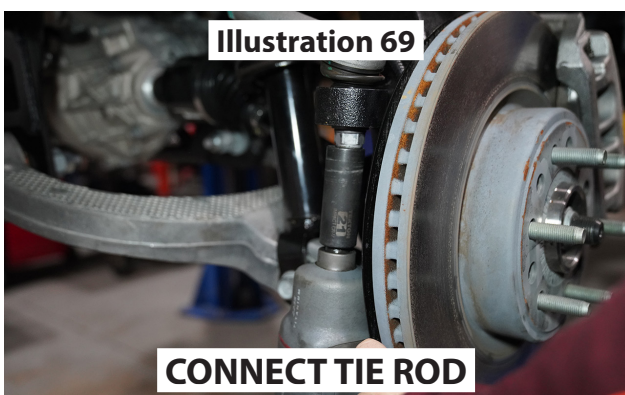
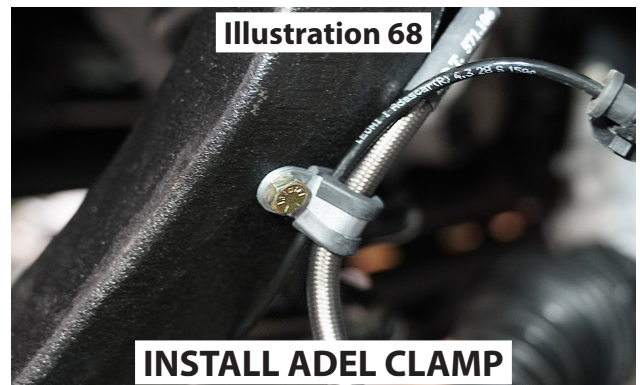

97. [Illustration 71] Tighten the upper ball joint nut. [21mm] (50)

98. [Illustration 72] Tighten the CV axle nut. [36mm] (185)

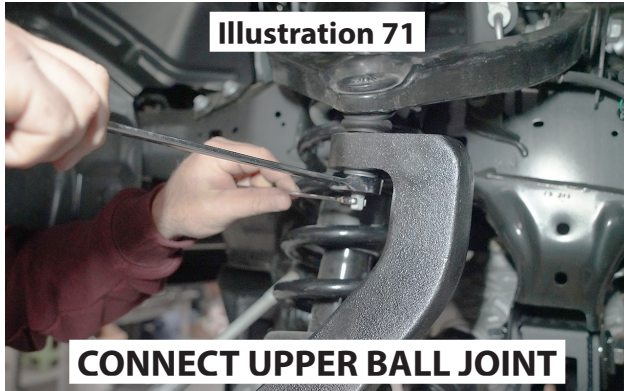

SWAY BAR

99. [Illustration 73] Install the new sway bar bracket (55-15-4750) to the frame using the factory hardware. [15mm] (35)

100. [Illustration 74] Install the sway bar body to the new brackets using the supplied 7/16" x 1-1/4" bolts, washers, and nyloc nuts. [5/8"] (50)

101. [Illustration 75] Install the sway bar links to the lower control arm using the factory hardware. [18mm]



BELLY PAN

102. [Illustration 76 & 77] Install the new belly pan (55-12-4750) using the supplied 3/8" carriage bolts and flange nuts. [9/16"] (25)

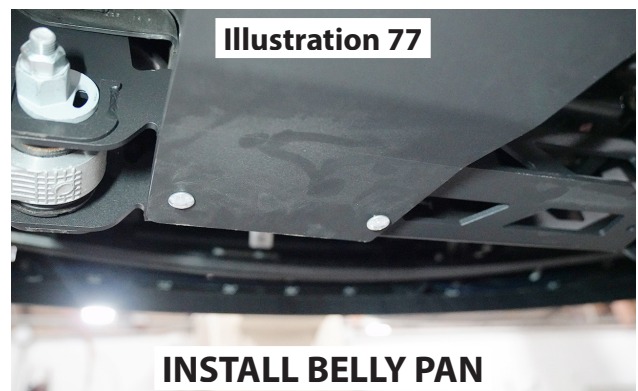
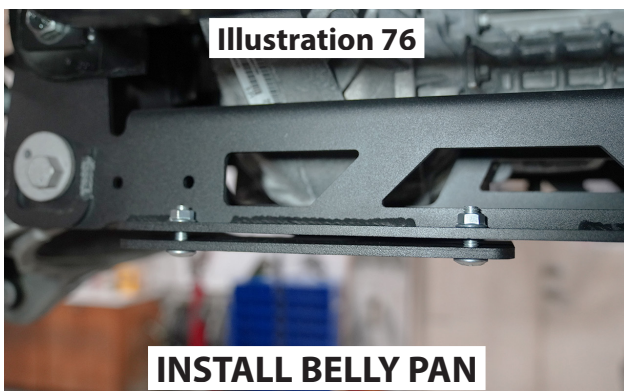

FRONT TIRES / WHEELS AND FRONT CLEARANCE CHECK

103. Install the front tires & wheels.

104. With the suspension 'hanging' at full extension travel, cycle the steering lock-to-lock and check all components for proper operation and clearances. Pay special attention to the clearance between the tires / wheels and knuckles, brake hoses, wiring, etc.

105. Lower the vehicle to the ground. Reconnect the battery.

106. With the vehicle on the ground, cycle the steering lock-to-lock and check all components for proper operation and clearances. Pay special attention to the clearance between the tires / wheels and knuckles, brake hoses, wiring, etc. NOTE: Re-tighten lug nuts at 500 miles after any wheel change, or anytime the lug nuts are loosened. Failure to do so could cause wheels to come off while vehicle is in motion.

TORQUE SEQUENCE

107. [Illustration 78] Tighten the lower control arm bolts, keeping the cam lobes in the neutral position. [24mm] (125)

108. [Illustration 79] Tighten the lower strut mount. [21mm, 24mm] (125)

109. [Illustration 80] Tighten the upper control arm bolts. [21mm] (125)

BRAKE HOSES

110. Bleed the front brake hoses. Failure to do so may cause serious injury.

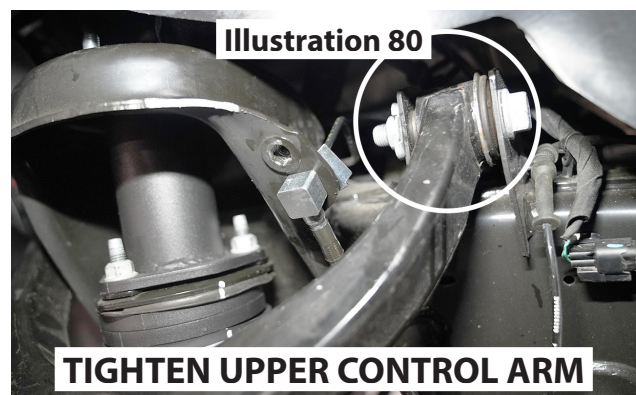
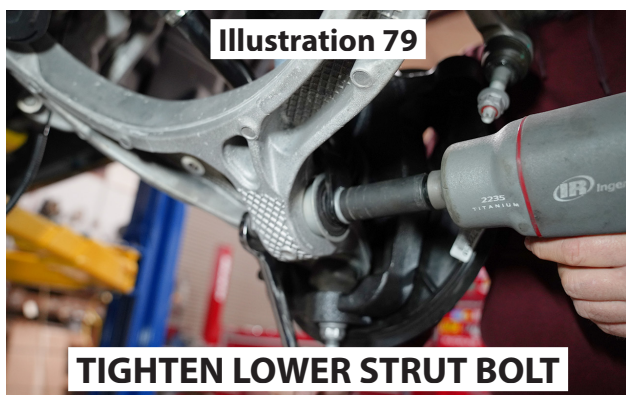
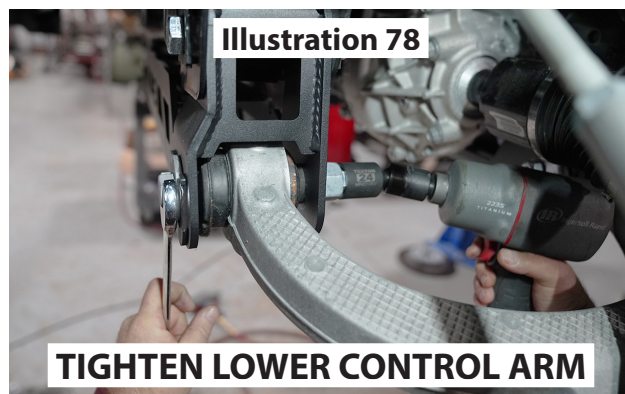

REAR DISASSEMBLY AND INSTALLATION

Save ALL factory components and hardware for reuse, unless noted.

PREPARE VEHICLE FOR REAR INSTALLATION

1. Chock front tires and place transmission in neutral.
2. Raise the rear of vehicle with a jack and secure a jack stand beneath each frame rail, just ahead of the link arm brackets.
3. Leave plenty of room to lower the rear axle and ease the frame down onto the stands, place transmission 'Park'.
4. Remove the rear wheels & tires.
5. [Illustration 81] Remove the plastic inner fender liner.
6. [Illustration 82] Unbolt the brake line brackets from frame. [13mm]
7. [Illustration 83] Remove the shocks from the vehicle. [21mm] [18mm]
8. [Illustration 84] Remove the sway bar links from the vehicle. [8mm, 18mm, 16mm]
9. [Illustration 85] Disconnect the differential vent hose, ABS wires, and the locker electrical plug, if equipped.

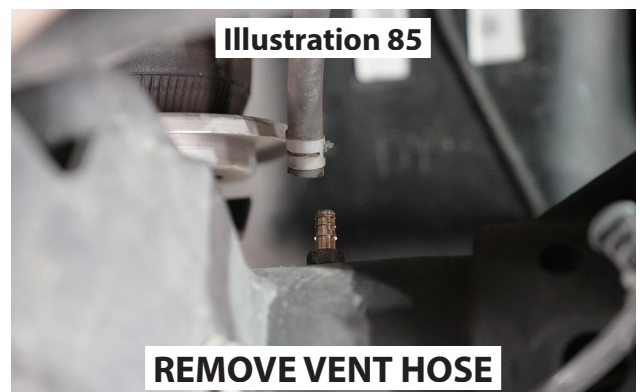
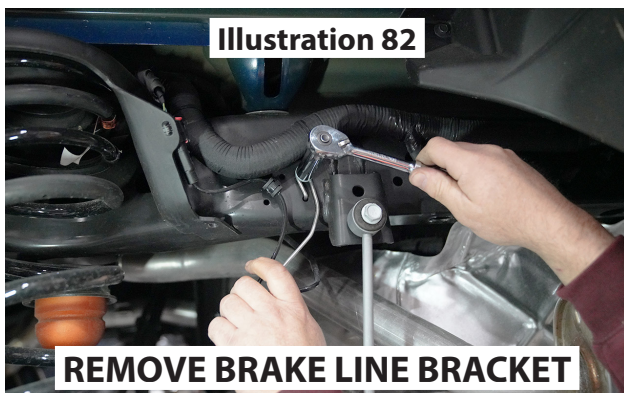
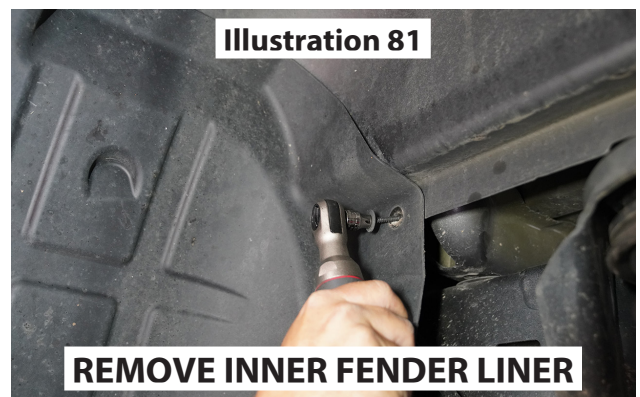

10. [Illustration 86] Disconnect the track bar from the frame and loosen at the axle end. [21mm]

11. [Illustration 87] Loosen both link arms on each side at both ends. [21mm, 24mm]

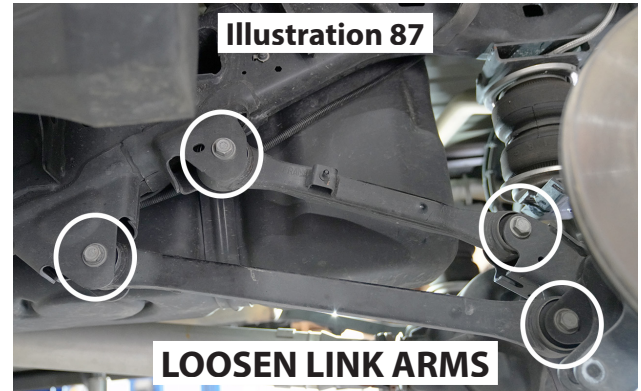

12. Support the rear axle with a hydraulic jack.

13. [Illustration 88] Make sure the parking brake is not engaged and disconnect the electric parking brake connector then unclip wires from caliper.

14. [Illustration 89] Remove the brake calipers and hang up out of the way. [21mm] NOTE: DO NOT LET THE CALIPERS HANG FROM BRAKE HOSES.

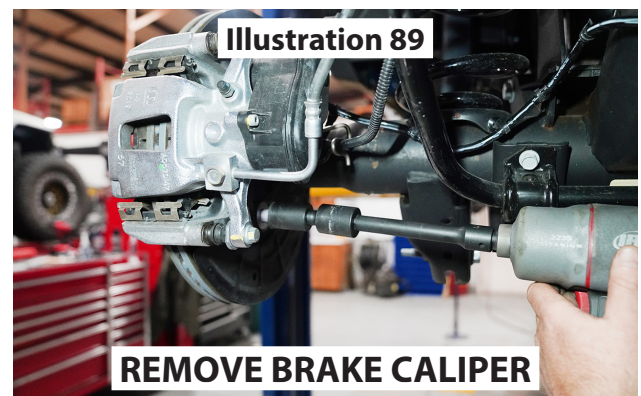
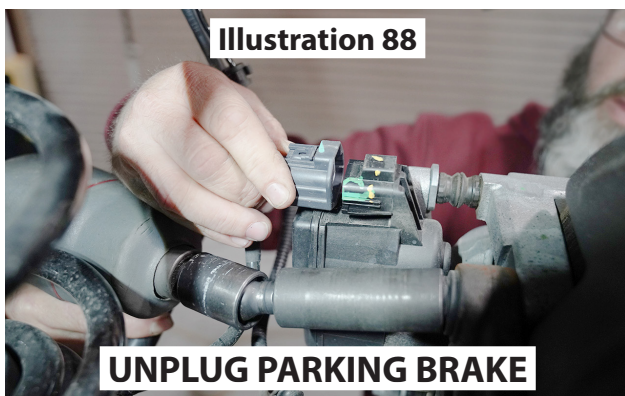

LINK ARMS

15. [Illustration 90] Lower the axle enough to remove the coil springs.

16. Disconnect the upper and lower link arms from the frame. [21mm, 24mm]

17. [Illustration 91] Measure from up from the bottom of the lower link arm bracket 3/4" mark then cut off from frame.



18. Debur the cut areas and paint all exposed metal.

19. [Illustration 92, 93, & 94] Install the new link arm brackets (driver side = 55-17-4750 / passenger side = 55-18-4750) and secure using the supplied 5/8" hardware. NOTE: If vehicle is equipped with an optional fuel tank skid plate, it will have to be notched to allow clearance for the new link arm bracket. The new bracket has a notch that allows it to fit around the factory bracket's rear leg.

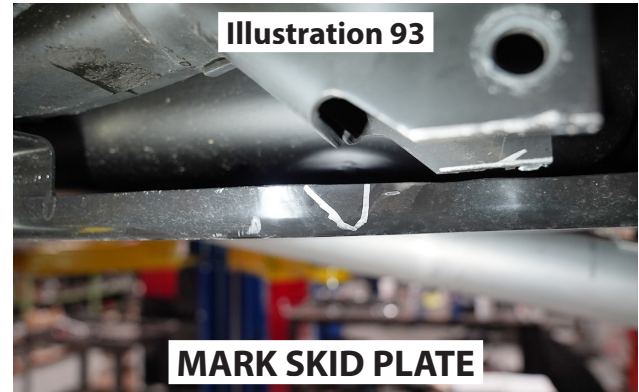

20. [Illustration 95] Install the 1/2" x 1-1/2" bolt through the bracket and frame then secure with a supplied tab nut (55-10-5070). [3/4"] (55)

21. Install the link arms into the new frame bracket using the factory hardware. [21mm, 24mm] Do not tighten at this time.

22. [Illustration 96] Tighten the 5/8" hardware securing the new link arm bracket to the frame. [15/16"] (150)

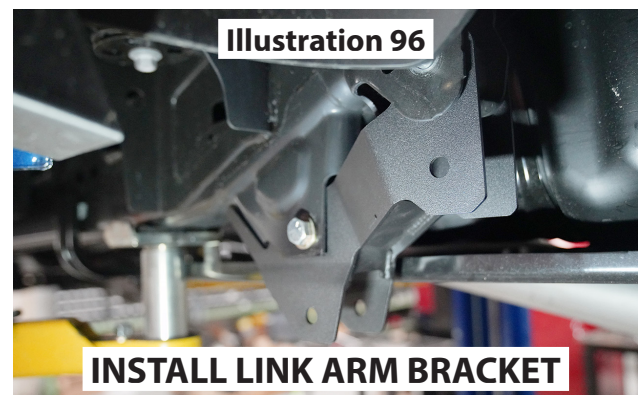
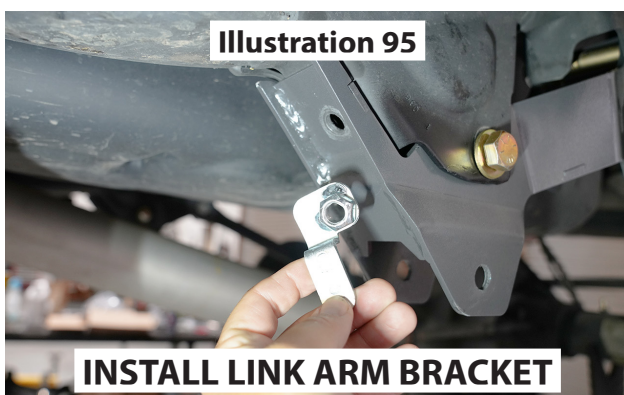
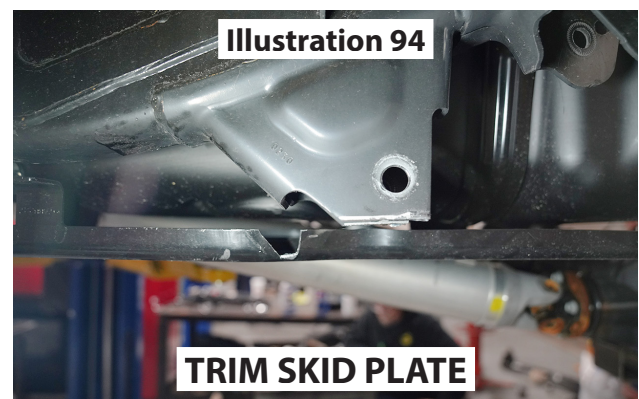

BUMP STOPS

23. [Illustration 97] Install the new bump stops (driver side = 55-27-4750 / passenger side = 55-28-4750) on the axle using the supplied 3/8" bolts, washers, flange nuts. [9/16"] (30)



TRACK BAR

24. [Illustration 98] Install the new track bar bracket (55-13-4750) to the frame using the supplied 1/2" x 1-1/4" and 9/16" x 3" bolts, washers, and nuts. [3/4", 13/16", 7/8"] Do not tighten any of the bolts at this time. The "leg" of the track bar bracket goes inside the frame and the 1/2" x 1-1/4" bolt goes from the top down so the flange nut is inside the bracket. The bracket is then attached to the frame at the factory track bar mount using the 9/16" x 3" bolt, washer, and nyloc nut with the bolt inserted from front to back. Lastly the outside tab can be secured to the frame using the supplied 1/2" x 1-1/4" bolt, washer, and flange nut.

25. [Illustration 98] Tighten the 9/16" bolt that is in the factory track bar location. [13/16", 7/8"] (105)

26. [Illustration 98] Tighten the 1/2" bolt on the outside of the track bar bracket. [3/4"] (55)

27. [Illustration 99] Tighten the 1/2" bolt on the inside of the track bar bracket. [3/4"] (55)

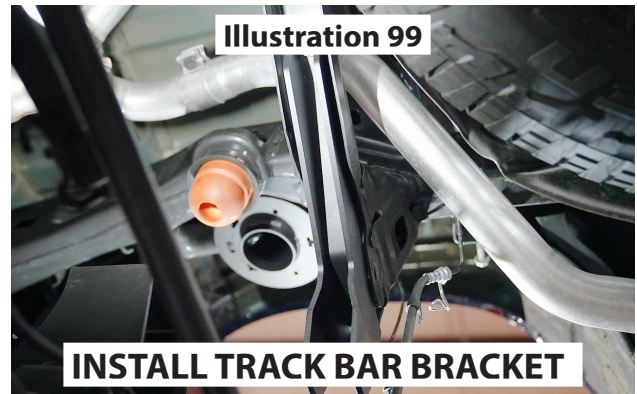
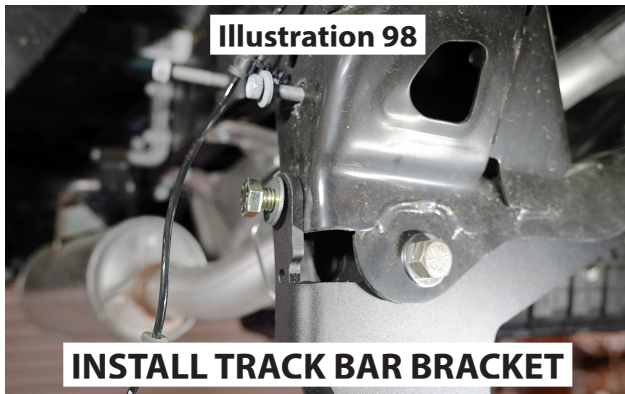

COIL SPRING SPACERS

28. [Illustration 100 & 101] Assemble the new coil spring spacer (top half = 55-60-4594 / bottom half = 55-61-4594) using the supplied 7/16" x 1-1/4" carriage bolts and flange nuts in the middle hole of the spacers. [5/8"] (50)

29. [Illustration 102] Install the 5/16" x 1" bolts into the top of the top side so they are pointing upward and secure them with a push nut so the flat side points to the bracket.

30. [Illustration 103] Install spacer into the frame with the slotted hole facing to the front of the vehicle and secure with supplied 5/16" flange nuts. [1/2"] (20)



31. [Illustration 104] Install the factory coil springs and raise axle to seat coil springs properly. NOTE: The upper isolator pads have two tabs and can only be installed one way.



SHOCK ABSORBERS

32. [Illustration 105] Install new shocks (01-88540) with the body down and shaft up using the factory hardware. [18mm, 21mm] (100)

BRAKES

33. Install the brake calipers using the factory hardware and thread locker. [21mm] (120)

34. [Illustration 106] Reconnect the wiring harness and plug in connector.

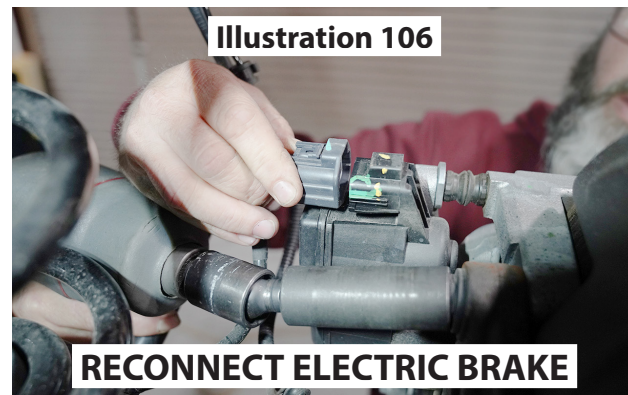

35. [Illustration 107] Install the new rear brake line bracket (55-22-4750) to the frame on the driver side in the factory brake line bracket location using the factory hardware.

36. [Illustration 107] On the driver side unclip the metal brake line from the frame at the first clip located above the rubber line. Gently pull down and reform the line to allow the factory brake line bracket to be bolted to the new brake line bracket using the supplied 5/16" x 1" bolt, washers, and nyloc nut. [1/2"] (15)

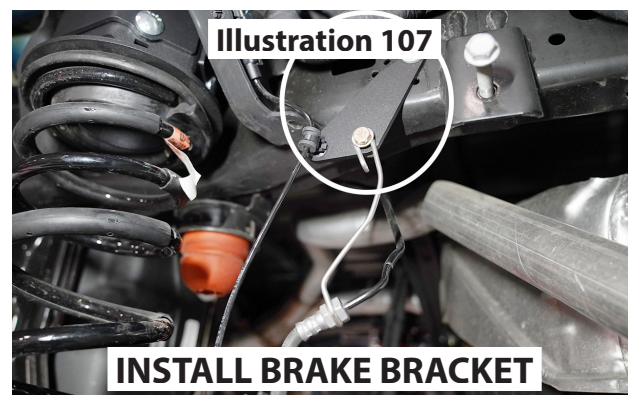

37. [Illustration 108] On the passenger side unclip the metal brake line from the frame at the first clip located above the rubber line. Gently pull down and reform the line to allow the factory brake line bracket to be bolted to the new track bar bracket using the supplied 5/16" x 1" bolt, washers, and nyloc nut. [1/2"] (15)

SWAY BAR

38. Locate the new sway bar link (55-14-3310), bushings (01-60416), and sleeves (01-60454 and 01-60450). Install the new bushings and one sleeve in one eye and the other sleeve in the other.

39. [Illustration 109] Install the sway bar link to the frame using the factory bolt and supplied washer. [16mm] (80)

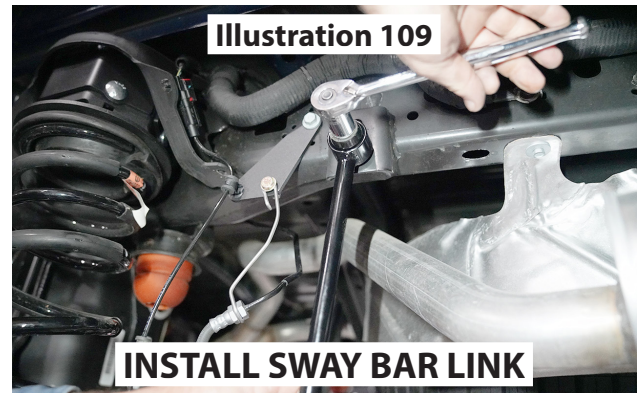
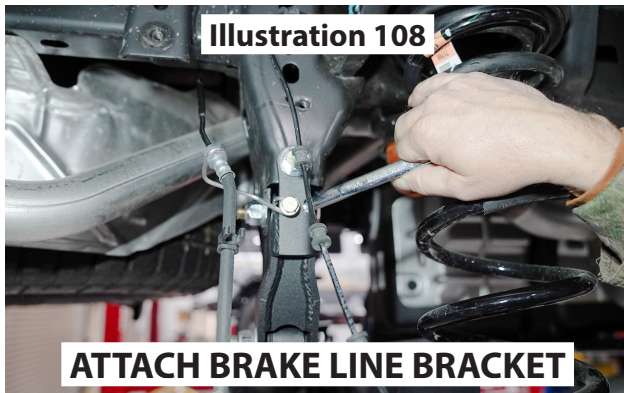

40. [Illustration 110] Attach the sway bar link to the axle using the supplied 1/2" x 2-3/4" bolt and small washer through the sway bar body then link with the larger washer and nyloc nut on the outside. [3/4"] (50)

41. [Illustration 111] Reinstall the plastic inner fender liner using the factory hardware.

**REAR TIRES / WHEELS**

42. Install the rear tires & wheels.

43. Lower the vehicle to the ground.

TRACK BAR

44. [Illustration 112] Install the track bar to the track bar bracket using the factory hardware. [21mm] (130)



LINK ARMS

45. [Illustration 113] Tighten the link arms to the frame brackets. [21mm, 24mm] (210)
46. Tighten the link arms to the axle brackets. [21mm, 24mm] (210)
47. [Illustration 114] Connect the differential vent hose, ABS wires, and the locker electrical plug, if equipped.

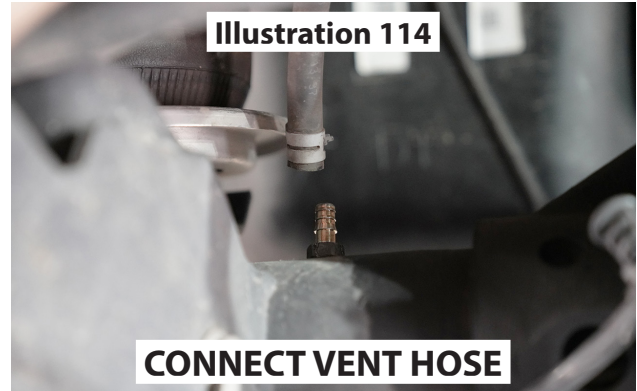
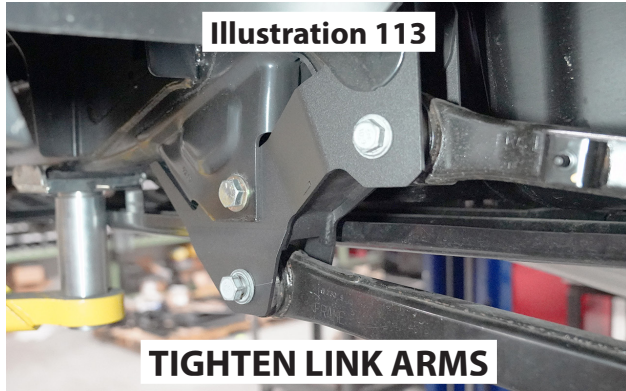

FINAL CHECKS

1. Check all hardware for proper torque specifications.
2. With the vehicle on the ground, check all components for proper operation and clearances. Pay special attention to the clearance between the tires / wheels, brake hoses, wiring, etc.
3. Check tire/wheel clearance with the fenders/bumper as well as with the steering knuckle. Depending on your choice of tire size and wheel width, it is not uncommon to trim the lower plastic valance of the bumper and inner fender shroud slightly to add proper tire clearance while turning.
4. Align vehicle to factory specifications.
5. Adjust headlights to proper setting.
6. Activate the four wheel drive system and check for proper engagement.
7. Install the **WARNING TO DRIVER** decal on the inside of the windshield or sun visor, within Driver's view.

IMPORTANT MAINTENANCE INFORMATION

It is the ultimate buyer's responsibility to have all bolts / nuts checked for tightness after the first 100 miles and then every 1000 miles. The steering, suspension and driveline systems, plus wheel alignment should be inspected by a qualified professional mechanic at least every 3000 miles.

LIMITED LIFETIME WARRANTY / WARNINGS

Your SUPERLIFT® product is covered by the Limited Warranty explained below that gives you specific legal rights. This limited warranty is the only warranty SUPERLIFT® makes in connection with your product purchase. SUPERLIFT® neither assumes nor authorizes any retailer or other person or entity to assume for it any other obligation or liability in connection with this product or limited warranty.

SUPERLIFT, LLC, LIMITED LIFETIME WARRANTY

What is covered? Subject to the terms below, SUPERLIFT® will repair or replace its products found defective in materials or workmanship for so long as the original purchaser owns the vehicle on which the product was originally installed. Your warranter is SUPERLIFT, LLC, doing business as SUPERLIFT® Suspension Systems ("SUPERLIFT®").

What is not covered? Your SUPERLIFT® Limited Warranty does not cover products SUPERLIFT® determines to have been damaged by or subjected to:

- Alteration, modification or failure to maintain.
- Normal wear and tear (bushings, rod ends, etc.). Scratches or defects in product finishes (powder coating, plating, etc.).
- Damage to, or resulting from, the vehicle's electronic stability system, related components or other vehicle systems.
- Racing or other vehicle competitions or contests. Accidents, impact by rocks, trees, obstacles or other aspects of the environment.
- Theft, vandalism or other intentional damage.

Remedy Limited to Repair or Replacement. The exclusive remedy provided hereunder shall, upon SUPERLIFT's inspection and at SUPERLIFT's option, be either repair or replacement of the product covered under this Limited Warranty. Customers requesting warranty consideration should contact SUPERLIFT® by phone (1-800-551-4955) to obtain a Returned Goods Authorization number. All removal, shipping and installation costs are customer's responsibility.

If a replacement part is needed before the SUPERLIFT® part in question can be returned, you must first purchase the replacement part. Then, if the part in question is deemed warrantable, you will be credited / refunded.

OTHER LIMITATIONS - EXCLUSION OF DAMAGES - YOUR RIGHTS UNDER STATE LAW

- Neither SUPERLIFT® nor your independent SUPERLIFT® dealer are responsible for any time loss, rental costs, or for any incidental, consequential or other damages you may have.
- This Limited Warranty gives you specific rights, and this is the only warranty SUPERLIFT® makes in connection with your product purchase. You may also have other rights that vary from state to state. For example, while all implied warranties are disclaimed herein, any implied warranty required by law is limited to the terms of our Limited Lifetime Warranty as described above. Some states do not allow limitations of how long an implied warranty lasts and / or do not allow the exclusion or limitation of incidental or consequential damages, so the limitations and exclusions herein may not apply to you. SUPERLIFT® neither assumes nor authorizes any retailer or other person or entity to assume for it any other obligation or liability in connection with this product or Limited Warranty.

IMPORTANT PRODUCT USE AND SAFETY INFORMATION / WARNINGS

As a general rule, the taller a vehicle is, the easier it will roll over. Offset, as much as possible, what is lost in rollover resistance by increasing tire track width. In other words, go "wide" as you go "tall"; always use as wide a tire and wheel combination as feasible to enhance vehicle stability. We strongly recommend, because of rollover possibility, that the vehicle be equipped with a functional roll bar and cage system. Seat belts and shoulder harnesses should be worn at all times. Avoid situations where a side rollover may occur.

Generally, braking performance and capabilities are decreased when significantly larger / heavier tires and wheels are used. Take this into consideration while driving. Also, changing axle gear ratios or using tires that are taller or shorter than factory height will cause an erroneous speedometer reading. On vehicles equipped with an electronic speedometer, the speed signal impacts other important functions as well. Speedometer recalibration for both mechanical and electronic types is highly recommended.

Do not add, alter, or fabricate any factory or aftermarket parts to increase vehicle height over the intended height of the SUPERLIFT® product purchased. Mixing component brands is not recommended.

WE WANT TO SEE YOUR RIDE...

Grab photos of your SUPERLIFT Equipped truck in various poses and in action.

Email pictures to us at sales@superlift.com

Tag us on **Facebook**: [@superlift suspension systems](#)

Tag us on **Instagram**: [#superlift](#), [#superliftsuspension](#), [#superliftequipped](#)

<https://www.youtube.com/user/TheRealSuperlift>

THANKS For Choosing SUPERLIFT...

For questions, technical support and warranty issues relating to this SUPERLIFT products, please contact SUPERLIFT directly.

SUPERLIFT SUSPENSION
300 Huey Lenard Loop Rd.
West Monroe, Louisiana 71292
Phone: (318) 397-3000
Sales / Tech: (800) 551-4955
Fax: (318) 397-3040
SUPERLIFT.COM