



## INSTALLATION INSTRUCTIONS

### PRO-E ELECTRIC RUNNING BOARDS

#### APPLICATION:

RAM 1500 Crew Cab 2009-2018,  
RAM 1500 Crew Cab 2019-2023,  
RAM 2500/3500 Crew Cab 2010-2023.

#### PART NUMBER:

29-23565



Estimated Time to Complete Product Installation: 3 - 4 Hours



Westin Automotive Products, Inc.  
320 W. Covina Blvd  
San Dimas, Ca. 91773

# CONTENTS

- Component List Page 02
- Electrical Component Installation Procedure Page 05
- Mechanical Component Installation Procedure Page 11
- Product Warranty and Warnings Page 20

## COMPONENT LIST

ITEM	QUANTITY	DESCRIPTION	TOOLS NEEDED
1	2	RUNNING BOARD ASSEMBLY	5MM ALLEN WRENCH
2	1	DRIVER SIDE FRONT MOTOR LINKAGE	
3	1	PASSENGER SIDE FRONT MOTOR LINKAGE	13MM SOCKET
4	1	DRIVER SIDE REAR MOTOR LINKAGE	13MM WRENCH
5	1	PASSENGER SIDE REAR MOTOR LINKAGE	WIRE STRIPPER
6	1	CONTROL MODULE ASSEMBLY	ELECTRICAL TAPE
7	1	WIRING HARNESS	RATCHET
8	2	MAGNETIC INDUCTION MODULE	TORQUE WRENCH
9	4	LED LIGHTS	
10	1	POWER BOARD MANUAL SWITCH	
11	25	ZIP TIES	
12	2	FUSE	
13	4	DOOR MAGNET	
14	4	SUPPORT PLATE	
15	4	NUT PLATE	
16	4	BOLT PLATE	
17	4	SPACER PLATE	
18	2	SHORT M8 HEX FLANGE BOLT	
19	8	LONG M8 HEX FLANGE BOLT	
20	8	M6 HEX SOCKET CAP SCREW	
21	8	M6 HEX FLANGE BOLT	
22	4	M10 NUT	
23	4	M10 FLAT WASHER	
24	4	M10 SPLIT LOCK WASHER	

Remove the components from the box, verify if all parts listed are present and free from damage.

Carefully read and understand all instructions before attempting installation.

**Note that failure to identify damage before installation could lead to a rejection of any claim.**



Westin Automotive Products, Inc.  
320 W. Covina Blvd  
San Dimas, Ca. 91773

Thank you for choosing Westin products  
for additional installation assistance please call  
Customer Service (800) 793-7846  
www.westinautomotive.com

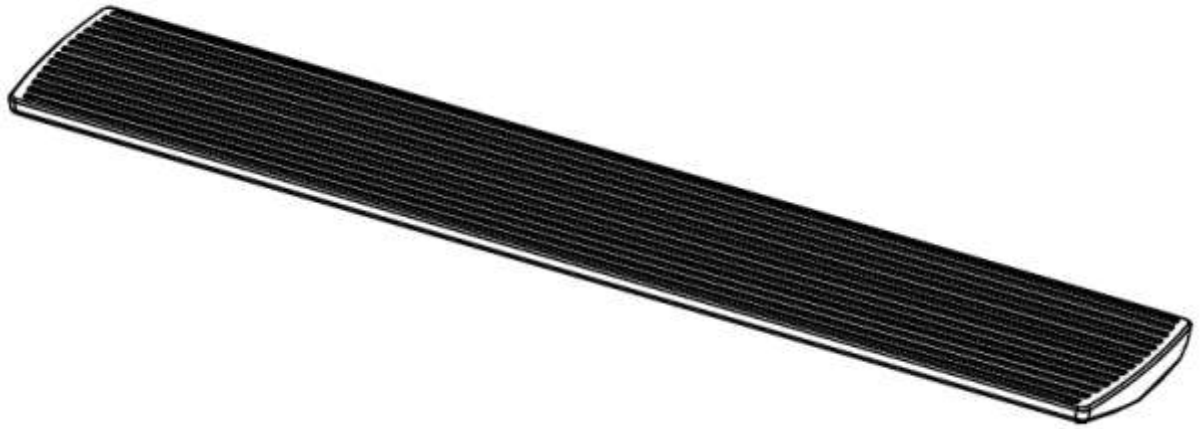

ITEM 1

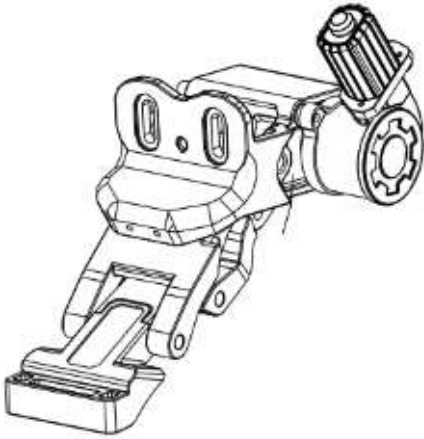

ITEM 2

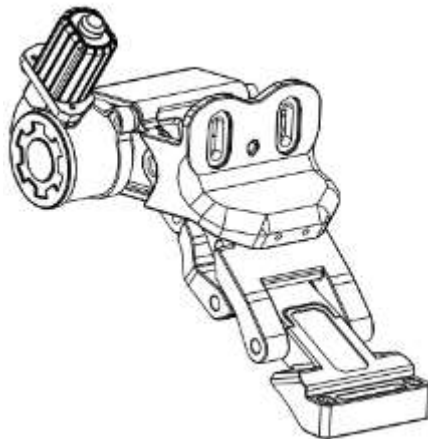

ITEM 3

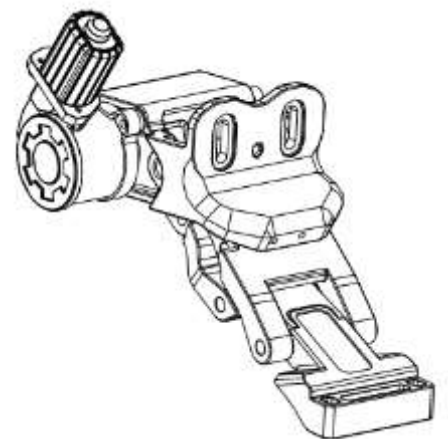

ITEM 4

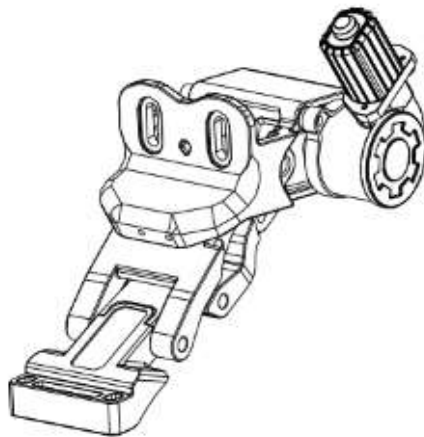

ITEM 5

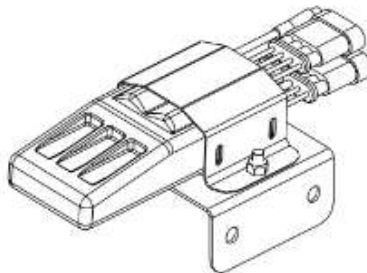

ITEM 6



ITEM 7



Westin Automotive Products, Inc.  
320 W. Covina Blvd  
San Dimas, Ca. 91773

Thank you for choosing Westin products  
for additional installation assistance please call  
Customer Service (800) 793-7846

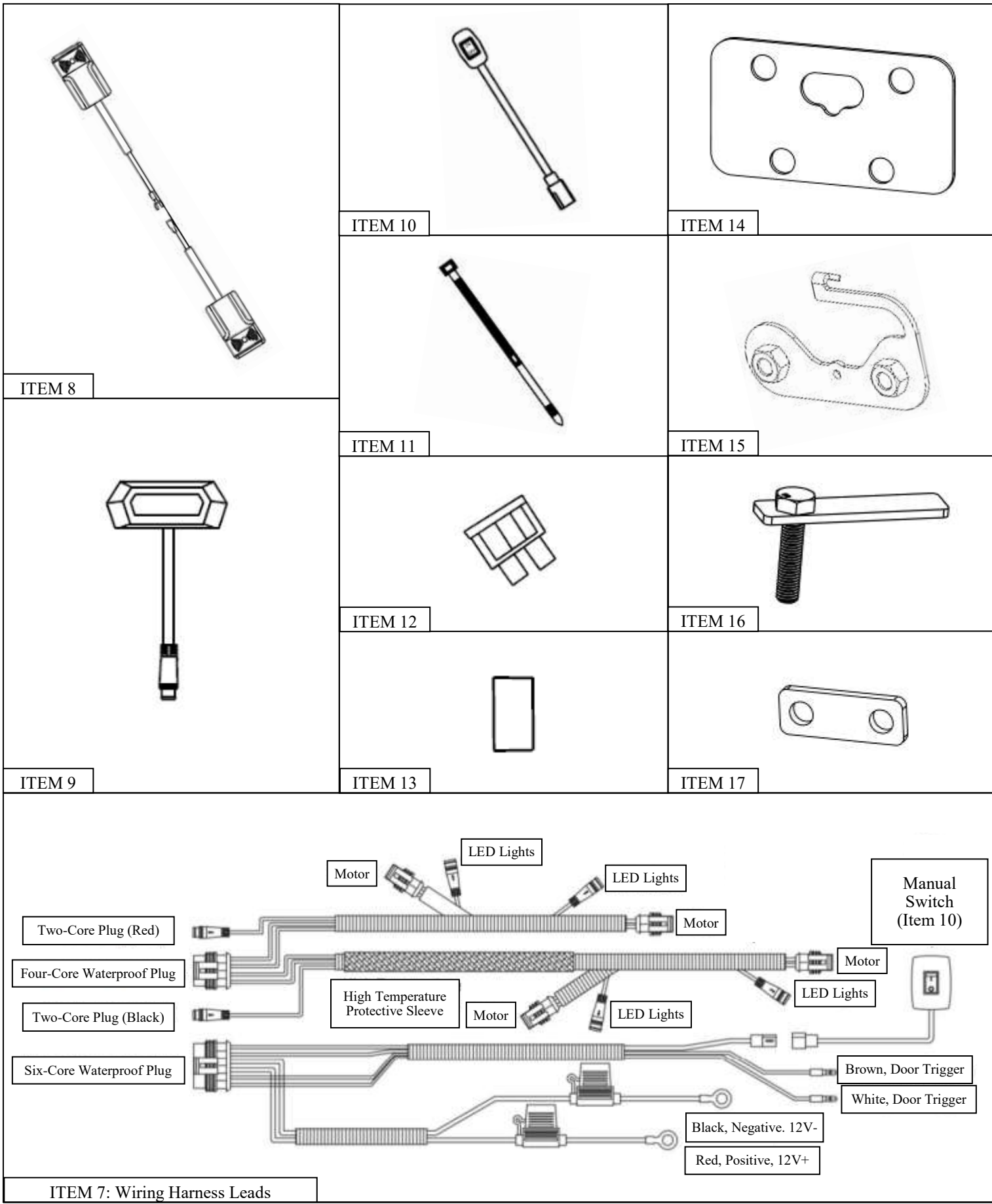

# ELECTRICAL COMPONENT INSTALLATION PROCEDURE

1. Begin by disconnecting the battery from the vehicle. Start with the negative battery terminal, then the positive battery terminal.
2. On both the driver and passenger side of the vehicle, remove the front door sill trim panel and the B-Pillar trim panel by carefully pulling on the panels enough to release them from the plastic retaining clips. (See **Figures 1 & 2** for reference).



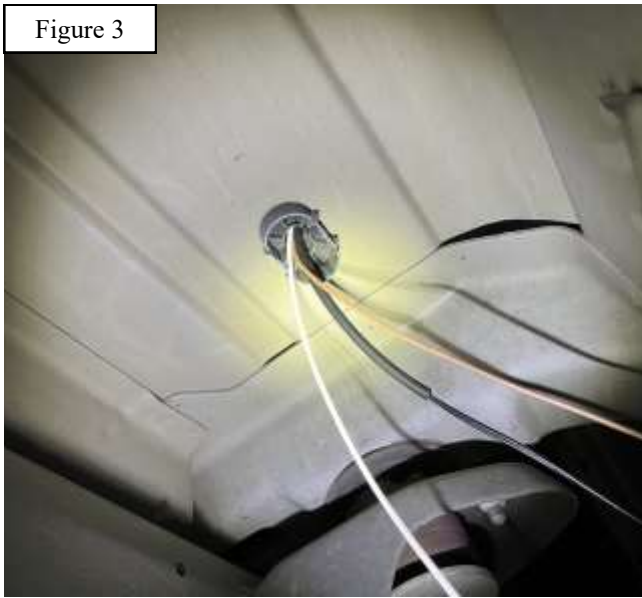

Figure 3

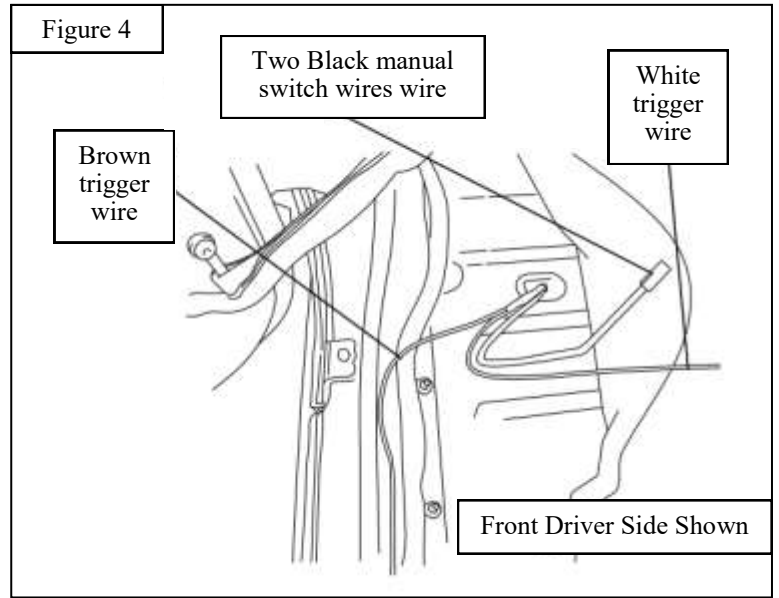

Figure 4

3. With the B-pillar panels removed, on the driver side pull carpet back and identify the plastic grommet located under the driver seat. Remove this grommet and drill or cut an opening for the wires to pass through. (See **Figures 3 & 4** for reference).
4. From under the vehicle feed the four wires, door trigger signal wires (**White & Brown**) and the two manual switch wires (**Two Black**) into the cab and through the cut hole in the grommet and place grommet back into place. (See **Figure 3** for reference). **Note:** To avoid possible water intrusion, it is recommended to use RTV Silicone Adhesive to seal the opening once the wires are fed into the cab.
5. Route the brown door trigger wire to the driver side B-Pillar. Then the door trigger wire (**White**) and manual switch wires (**Two Black**) under the front driver carpet towards the center console, at this point leave the manual switch wires (**Two Black**) hanging down near the driver pedals and continue to wire the door trigger wire (**White**) through the center console across to the passenger side. (See **Figure 5** for reference)

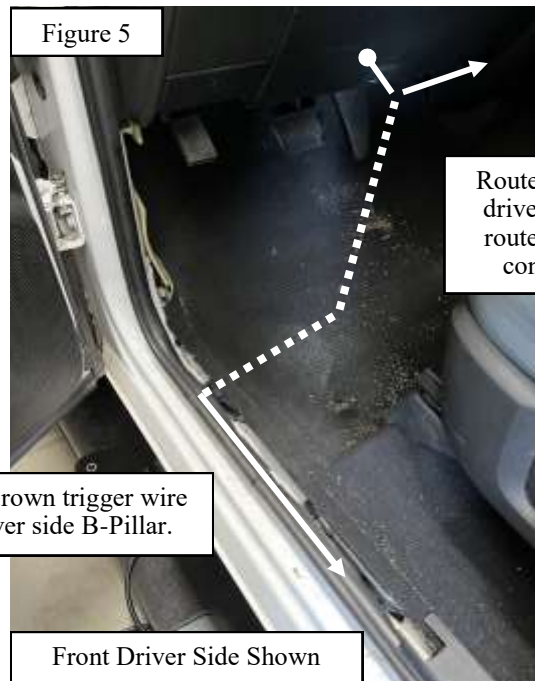

Figure 5

Route Black & White wires up under driver carpet, (leave the Black) then route White wire through the center console across to passenger side

Route the Brown trigger wire to the Driver side B-Pillar.

Front Driver Side Shown

6. You now need to ground the induction module wires. locate the seat belt assembly on the driver side behind the removed B-Pillar panel and loosen the bolt shown. Locate the magnetic induction module (Item 8) and mount the ground wire fork under the bolt of the seat belt assembly, then re-tighten bolt to provide a ground connection. Once grounded, connect the snap-in bullet connector on the module to the brown trigger wire and tuck wires away so it sits neatly under the side door sill panel. (See **Figure 6 & 7** for reference) It is also important to route the induction modules underneath the door seals so they rest in the front and rear door jamb. (See **Figure 8** for reference) you will stick these in place in later steps
7. Repeat **Step 6** to ground the side induction module to the passenger side B-pillar and connect the bullet connector to the white trigger wire that was previously routed through the center console, at this time route the white wire under the passenger side floor carpet to the passenger side B-Pillar so it is hidden.

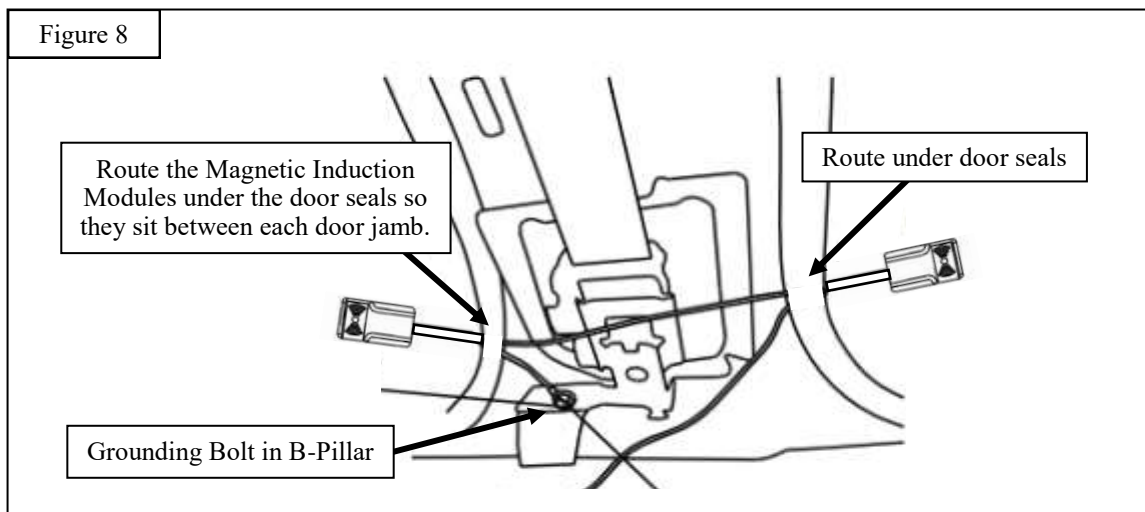
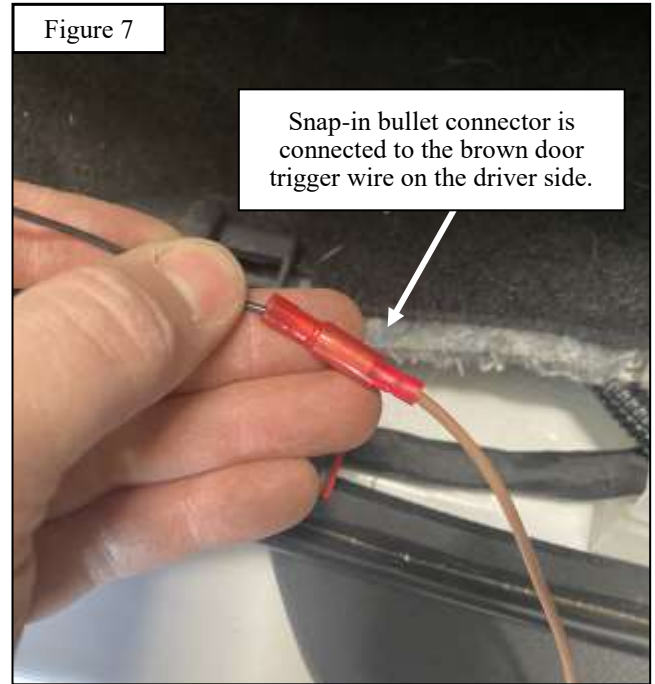
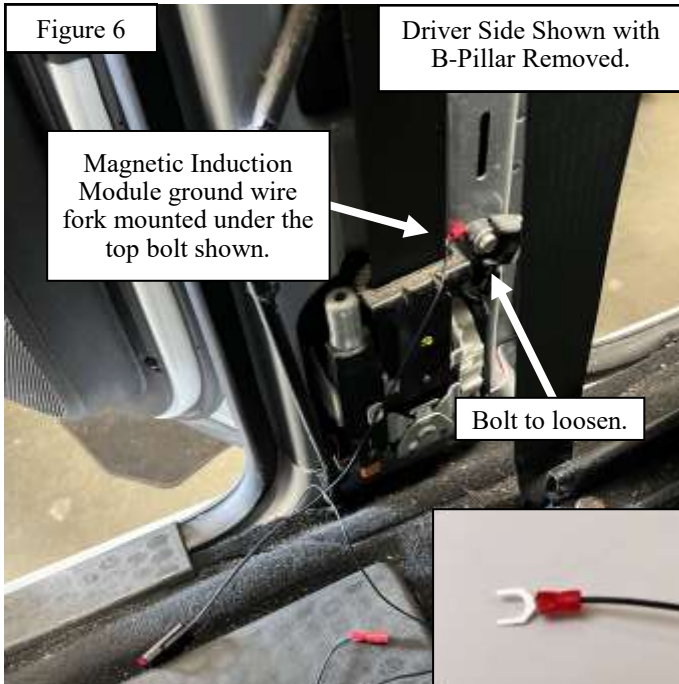

8. You are now ready to stick the induction modules and magnets to the Driver side B-Pillar and doors. Before doing this clean both surfaces with a damp rag with 50/50 mix of isopropyl alcohol and water.
9. Once the surface is completely dry, remove backing from the front magnetic induction module and place it 2” under the front driver B-pillar door striker located in the front driver side door jamb and “stick it in place”. (See **figure 9** for reference)
10. For the front driver magnet position, use a ruler and measure 2” down from the center of the door latch as a reference point. Prepare the surface by cleaning with a damp rag and 50/50 mix of isopropyl alcohol and water and proceed to place the magnet onto the door. (See **figure 10** for reference)

**Important: For these steps you need to make sure the magnetic induction modules line up with the door magnets when the door is closed, failure to do this will mean the step bar will not drop when door is opened.**

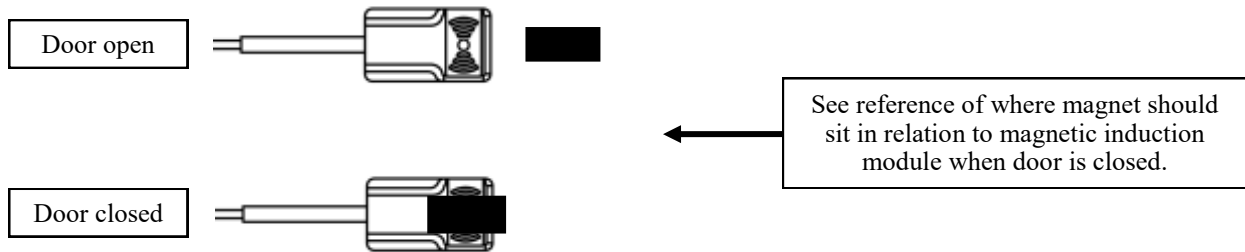



11. For the rear driver door, use a measuring tape and measure 4” down from the bottom of the black rubber seal on the inside of the door. Clean the surface with a damp rag with 50/50 mix of isopropyl alcohol and water, then proceed to stick the door magnet in place. (See **figure 11** for reference)
12. For the rear driver induction module, place a piece of masking tape horizontally from the top of the door magnet across to the door jamb, and stick the induction module in place so both items are sitting at the same vertical height on the vehicle, and will line up with each other when door is closed. (See **figures 11 & 12** for reference)
13. Repeat **Steps 8 through 12** on the passenger side, mounting the remaining magnetic induction modules and door magnets.

**Important:** For these steps you need to make sure the magnetic induction modules line up with the door magnets when door is closed, failure to do this will mean the step bar will not drop when door is opened.

*If the boards are not deploying once all of the wiring is connected, inspect and ensure that the magnets align with their corresponding module sensor.*

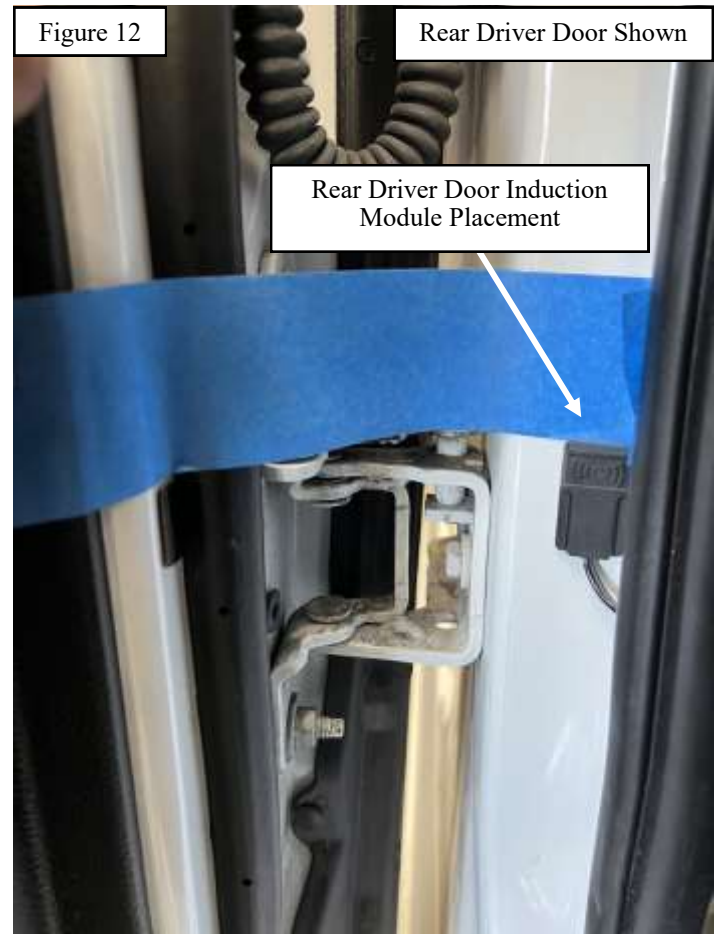
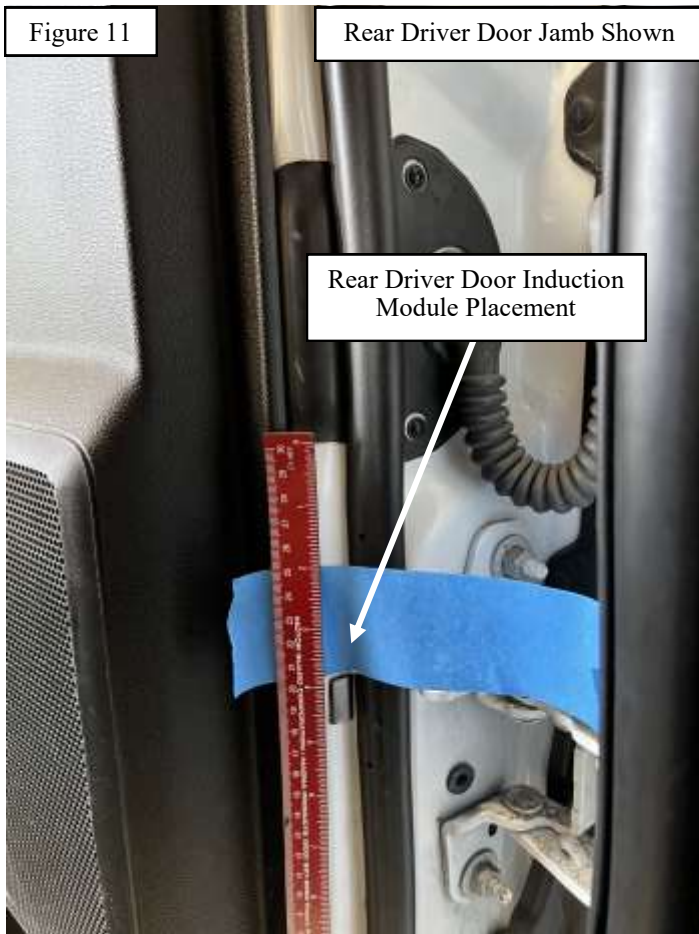

14. Locate the manual switch (Item 10) and connect it to the two black manual switch wires that were previously routed up through the front driver carpet.
15. You can now stick the manual switch to the driver side lower dash panel. To do this first prepare the desired mounting surface by using a damp rag with a 50/50 mix of isopropyl alcohol and water to clean the surface. Once the surface is dry, remove the double sided tape and stick the manual switch to the desired location. Neatly tuck or zip tie extra wiring away so that the switch cannot be tugged or pulled accidentally. (See **figure 13** for reference).
16. Moving back to the wiring underneath the vehicle, route the two fused power wires towards the front of the vehicle and feed the fused power wires into the engine compartment, leave them disconnected from the battery for now. (See **Figures 14 & 15** for reference).

**Manual Switch**



**Figure 13**

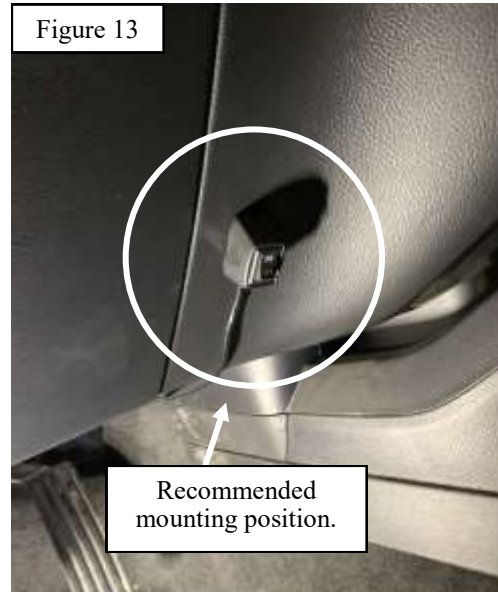

**Figure 14**

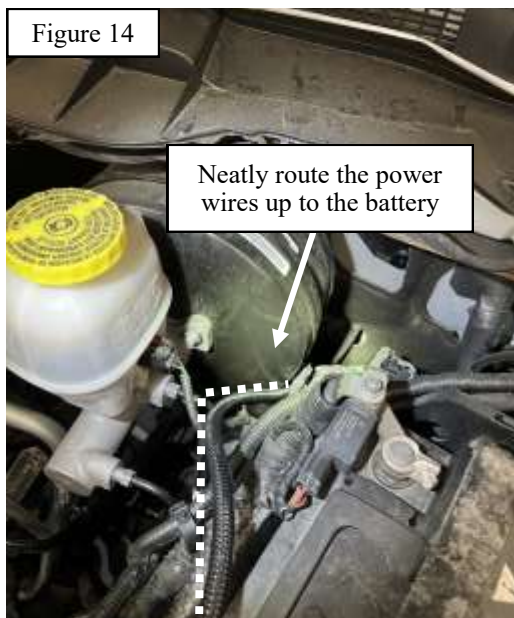

**Figure 15**



# MECHANICAL COMPONENT INSTALLATION PROCEDURE

17. Now you are ready to install the motor linkages and support plates to the frame of the vehicle.  
(Please refer to **Figure 16** for bracket orientation and locations).

**Note:** Motor linkages are etched, and label the corresponding mounting location to help aid with linkage placement.

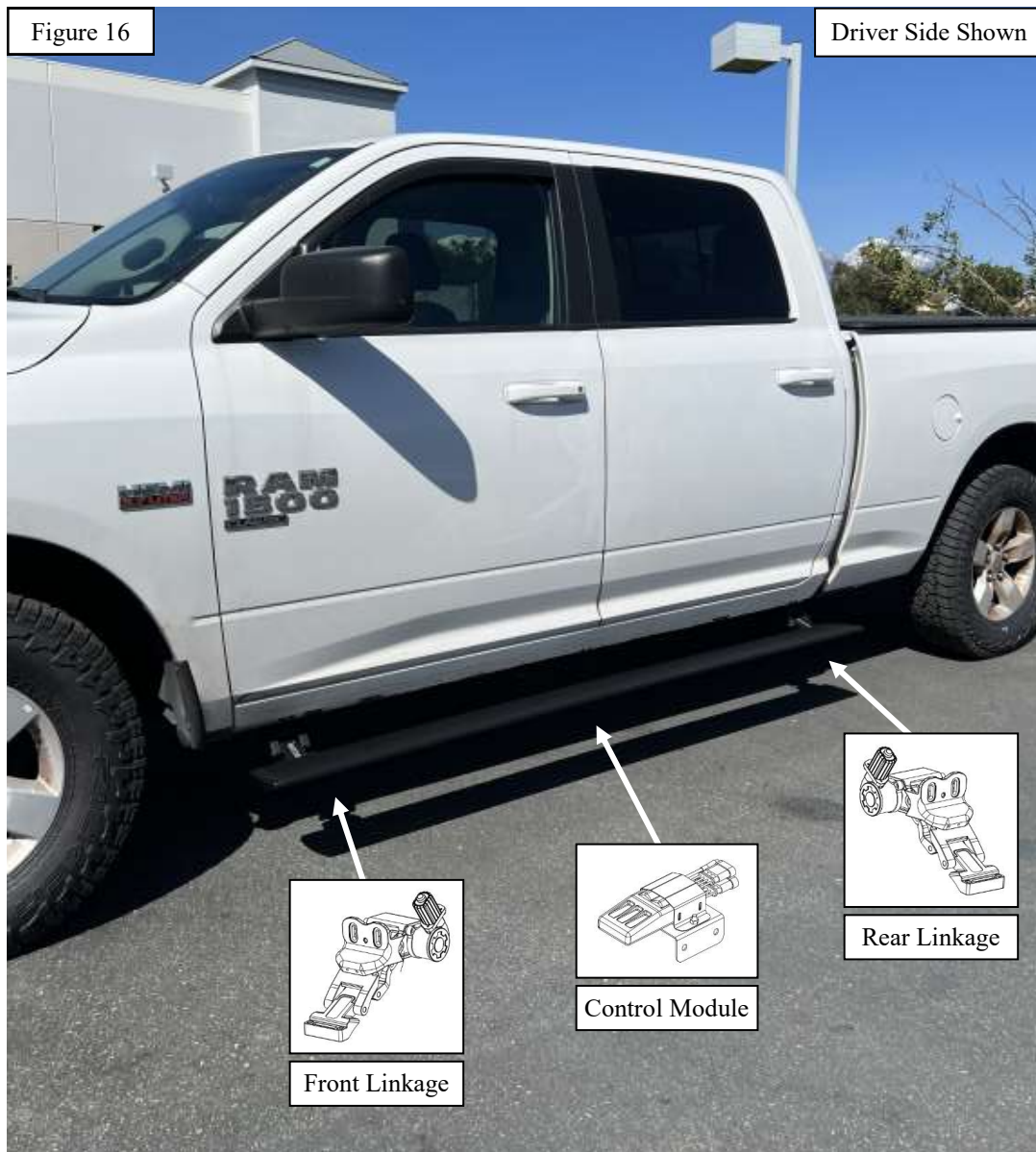

Westin Automotive Products, Inc.  
320 W. Covina Blvd  
San Dimas, Ca. 91773

18. Before installing the motor linkages you will need to mount the support hardware to the vehicle frame. This includes the nut plate (item 15) support plate (item 14) and the spacer plate (item 17). Begin by slotting the nut plate (item 15) into the vehicle frame and carefully allow the hook to catch on the edge of the frame hole (see **Figure 17** for reference) the nut plate will provide a thread inside the frame for the mounting bolts to screw into.
19. After the nut plate has been installed place the bolt plate (item 16) into the same frame hole with the thread sticking outwards so the bolt plate will catch onto the inside of the vehicle frame once tight. Fasten a M10 washer, M10 split lock washer, and M10 nut onto the bolt plate and tighten. The tightened bolt plate will help to hold the nut plate in position when attaching motor linkages (See **Figures 18 & 19** for how support plate (item 14), bolt plate (item 16) and spacer plate (item 17) will mount between the vehicle frame and motor linkage.

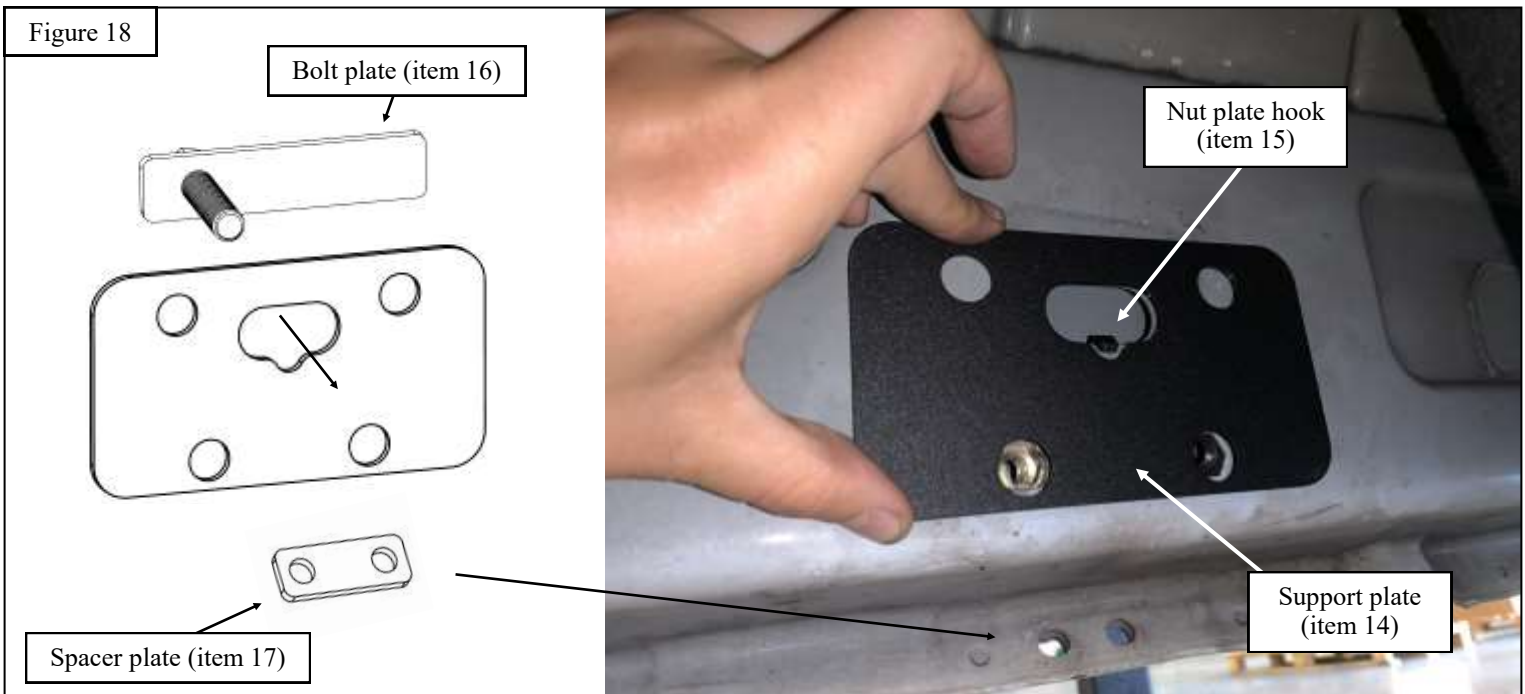

20. With the support plate, nut plate, and bolt plate in place, loosely install the driver rear motor linkage (Item 4) to the rear rocker panel mounting location using the supplied M8 hardware as shown in **Figures 19 & 20**. Once the motor linkage is loosely installed, slide the spacer plate (item 17) in-between the rocker panel and motor linkage and screw in the M6 hardware (item 21) to the base of the motor linkage. (See **Figure 21** for reference)

**Note:** Motor linkages are etched, and label the corresponding mounting location to help aid with linkage placement.

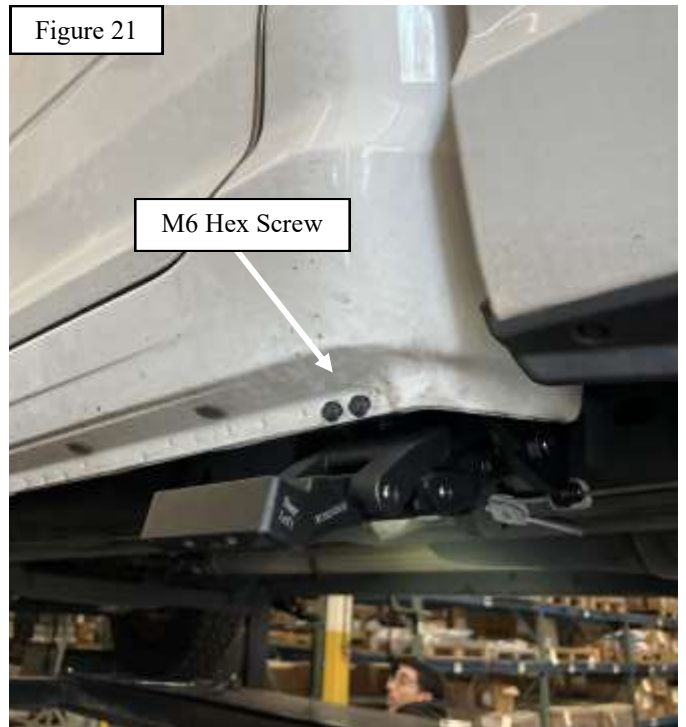
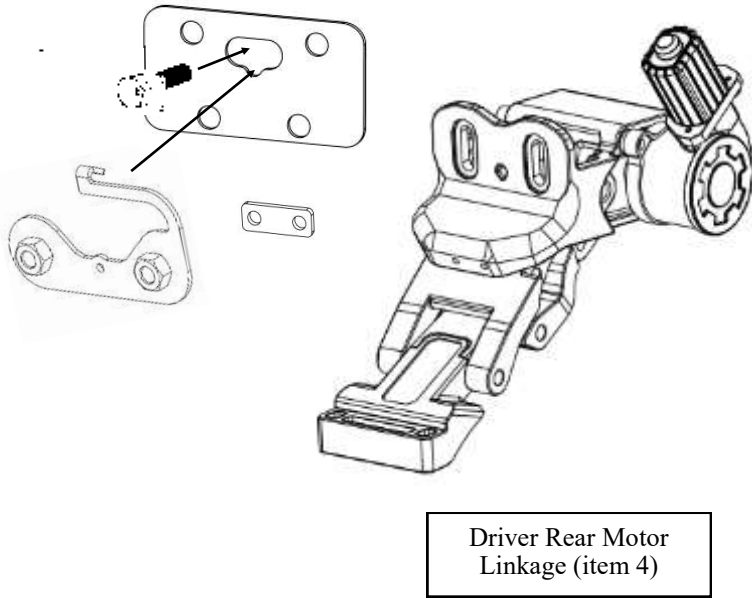

21. To mount the front motor linkage and support plate you will need to undo the support beam that is bolted to the vehicle frame, undo the support beam bolts and slide the support plate in-between then re-tighten bolts. (see **Figure 23** for reference) with the support plate in place insert the nut plate (item 15) and bolt plate (item 16) into the frame, then fasten a M10 washer, M10 split lock washer, and M10 nut onto the bolt plate thread and tighten.
22. With the support plate, nut plate and bolt plate in place, loosely install the driver front motor linkage (Item 2) to the front rocker panel mounting location using the supplied M8 hardware. With the motor linkage loosely installed, slide the spacer plate (item 17) in between the rocker panel and motor linkage and screw in the M6 hardware (item 21) to support the base of the motor linkage (see **Figure 24** for reference).

**Note:** Motor linkages are etched, and label the corresponding mounting location to help aid with linkage placement.

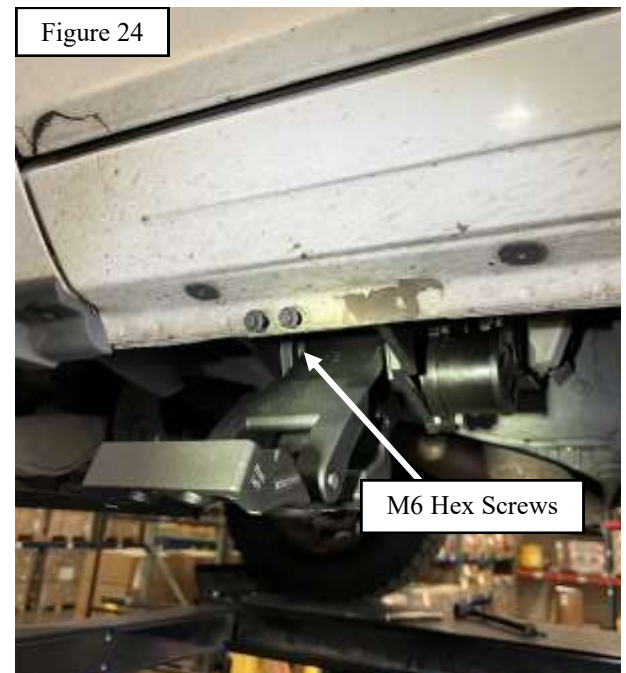
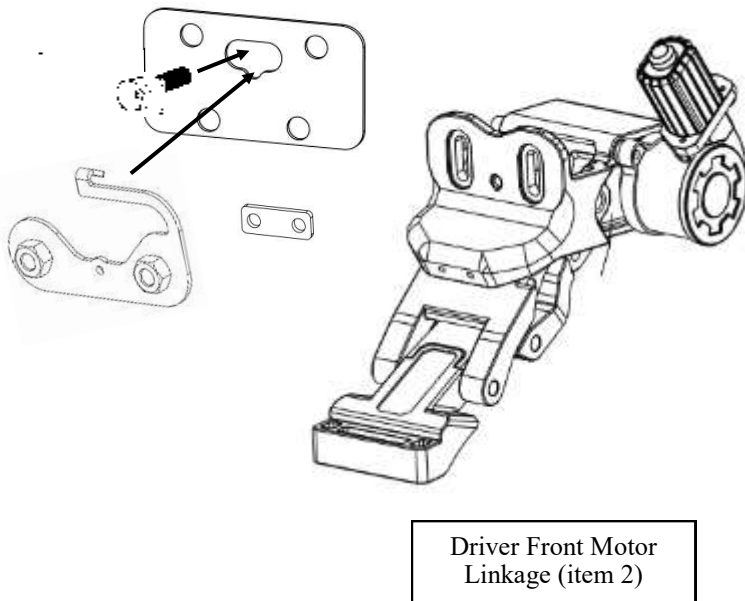
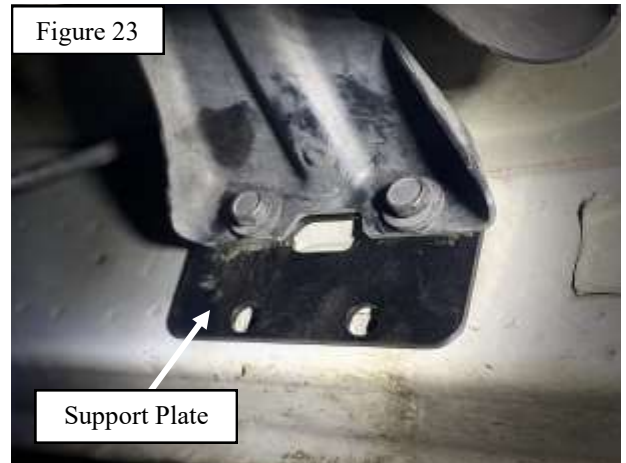

23. Loosely install the control module assembly (Item 6) to the center mounting location on the rocker panel using the supplied M8 hardware. (See **Figure 25** for reference)

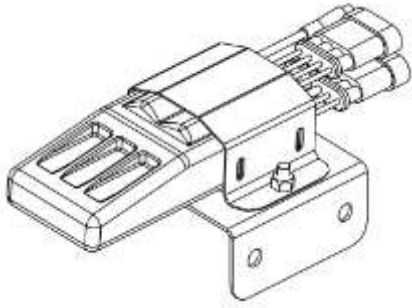

Control Module Assembly

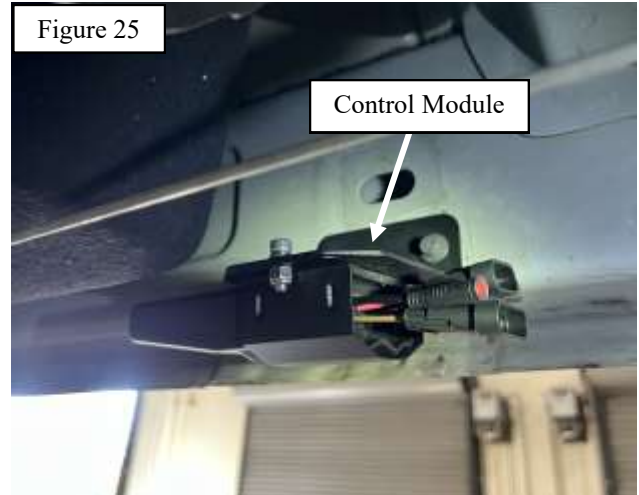

24. With assistance, loosely install one of the running board assemblies (Item 1) to the passenger side of the vehicle. Position the board on the front and rear motor assembly bases, and align the sliding T-Nut on the running board with the corresponding slots on the front and rear motor bases. Once the T-Nuts are aligned, slightly rotate the running board to allow the T-Nuts to set into the slots on the motor bases. (See **Figure 26 & 27** for reference).
25. Repeat **Step 24** for the driver side of the vehicle.
26. Align and adjust both the motor linkage assemblies and driver and passenger side running boards to the desired positioning. Use the supplied hex M6 socket cap screws (Item 20) to secure the running board to the motor linkage arms.
27. Once all components have been adjusted to the desired positioning, fully tighten and torque all hardware as specified: M6 hardware to 8-9 ft-lbs., M8 hardware to 15-18 ft-lbs.,

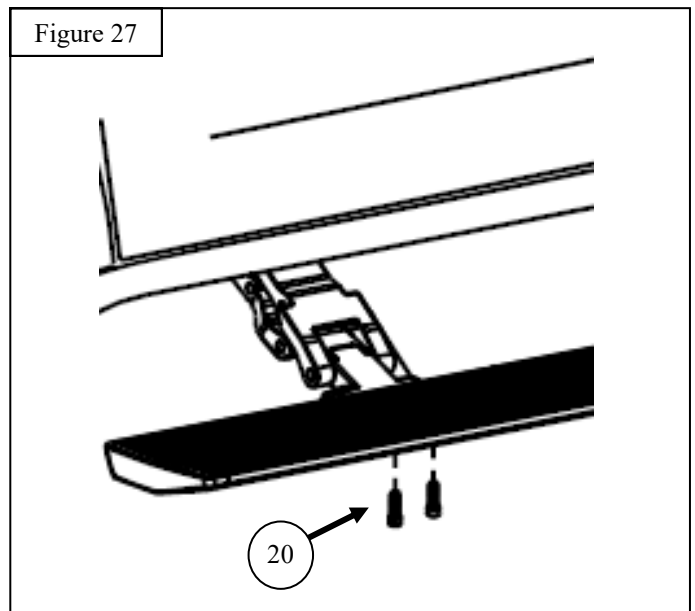
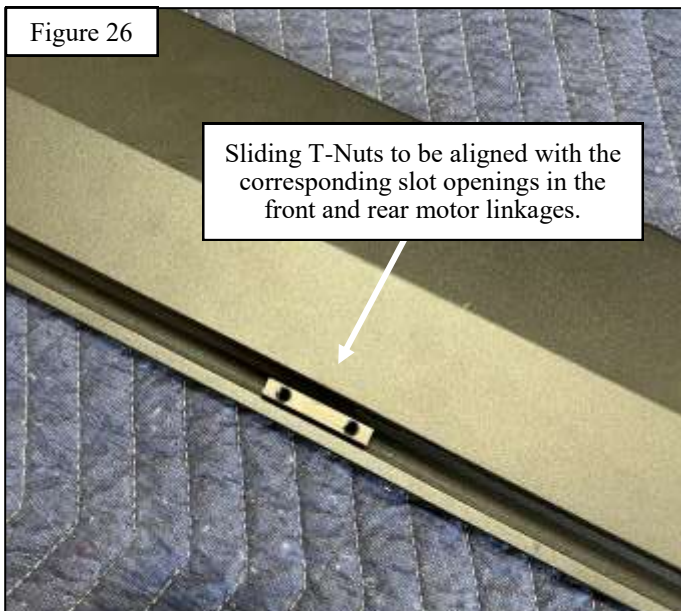

28. Locate the LED Lights (Item 9) and prepare the designated mounting surface on the vehicle frame by cleaning it with a damp rag with 50/50 mix of isopropyl alcohol and water, allow the surface to dry completely before peeling the backing off the double sided tape and sticking the LED lights to the designated mounting surface. (See **Figures 28 & 29** for reference).

Figure 28



Place two LED's (item 9) on each side to illuminate step bar when door is opened.

Figure 29

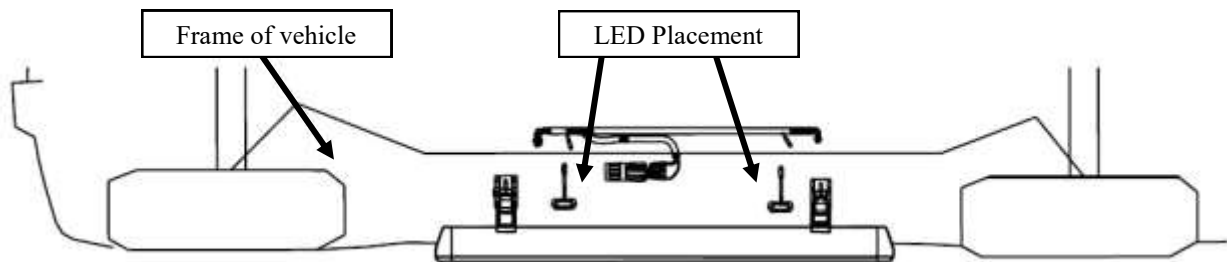



29. Route the electrical harness to the designated locations of the control module and motor linkages. Route the corresponding male connector plug to the corresponding female connector are per the labeling on the harness and motor linkage. For example, the male connector labeled “Front Left,” will be routed to the front driver side of the vehicle, and the “Front Right” should be routed to the front passenger side of the vehicle. The male connectors for the control module will be routed to the center driver side. (See **Figures 30 through 33** for reference). For the LED’s align the arrows on the LED Light male connectors to the arrow on the female connector on the main wiring harness.

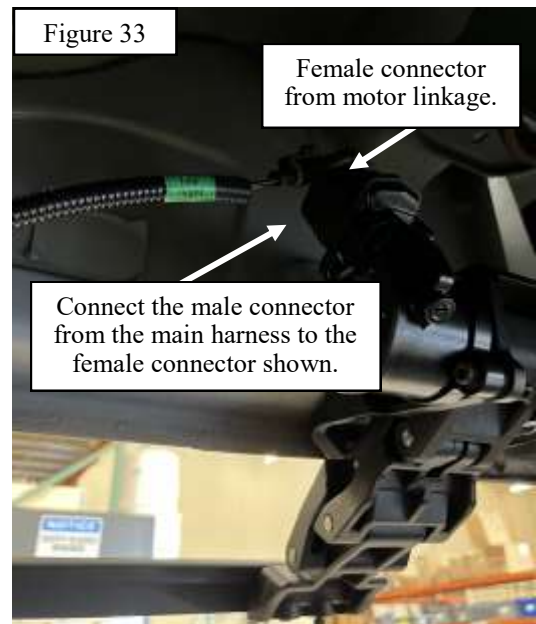
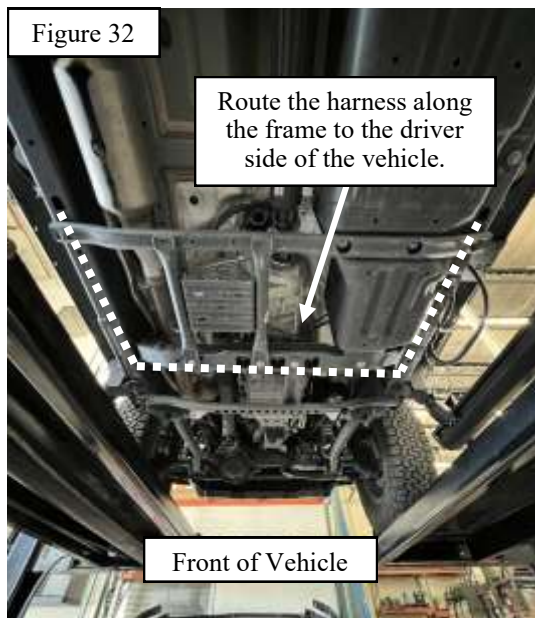
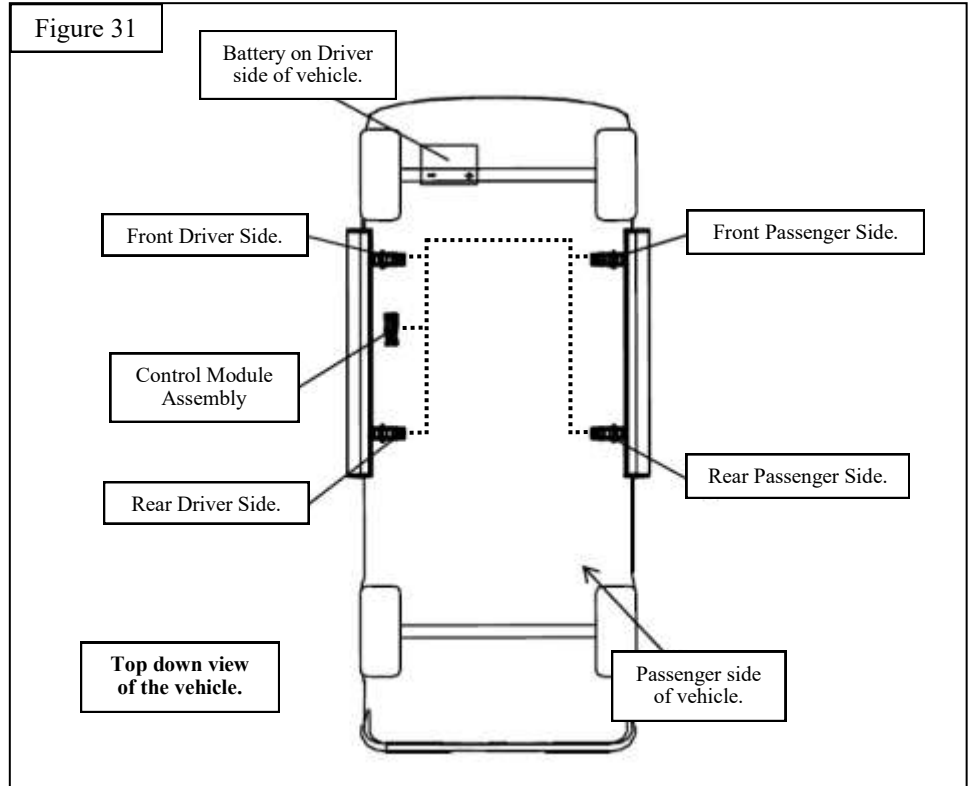
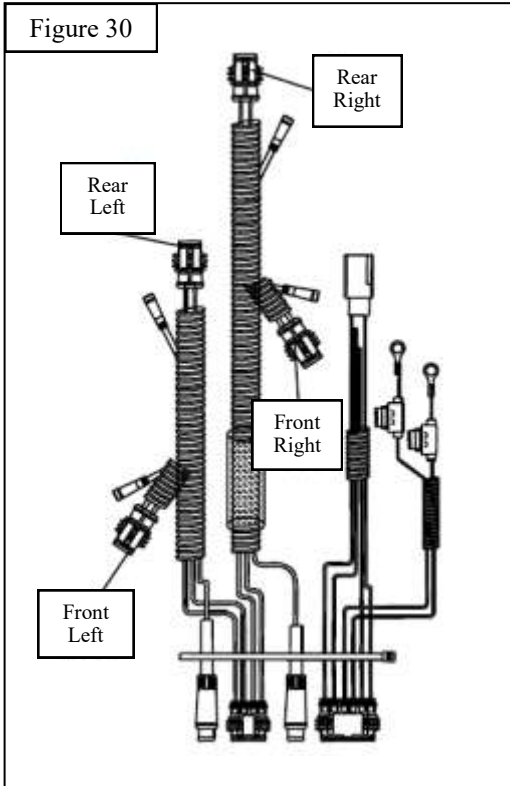

30. With all of the motor linkages, LED Lights, and control module plugs securely connected, return to the two control input wires in the engine compartment. Firstly remove the two fuses (Item 12) from both power wires. Then carefully connect the positive (**Red Wire**) to the positive battery terminal and the negative (**Black Wire**) to the negative battery terminal. Once the wires are connected to the battery, reinstall the previously removed fuses and neatly tuck away all wiring using the provided zip ties (Item 11).

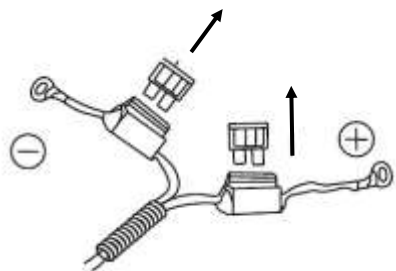

Remove fuses from both power wires before connecting to the battery

Figure 34



31. With all of the wiring connectors securely plugged in, open the driver side door and ensure the manual switch is in the 'on' position. If left 'off' this will disable the operation of the running boards.
32. Open and close all of the vehicles doors one by one to ensure that the running boards operate appropriately. If the running boards operate properly, the installation is complete. If they do not, check all the wiring connections and make sure that the magnets on the doors align with their corresponding control module.

**Note:** Any misalignment between the magnets on the doors and their corresponding Magnetic Control Module can prevent the running boards from opening and closing properly.

33. With the running boards operating properly, neatly tuck away all wiring using the provided zip ties (Item 11).

**INSTALLATION COMPLETE**



**CARE INSTRUCTIONS**

- REGULAR WAXING IS RECOMMENDED. DO NOT USE ANY TYPE OF POLISH OR WAX THAT MAY CONTAIN ABRASIVES.
- STAINLESS STEEL PRODUCTS CAN BE CLEANED WITH MILD SOAP AND WATER. STAINLESS STEEL POLISH SHOULD BE USED TO POLISH SMALL SCRATCHES.
- GLOSS BLACK FINISHES SHOULD BE CLEANED WITH MILD SOAP AND WATER.



Westin Automotive Products, Inc.  
320 W. Covina Blvd  
San Dimas, Ca. 91773

Thank you for choosing Westin products  
for additional installation assistance please call  
Customer Service (800) 793-7846  
[www.westinautomotive.com](http://www.westinautomotive.com)

DATE: 10/10/2023



## WARNING



Failure to follow these instructions could lead to death, personal injury, and / or property damage.

Failure to follow these instructions could lead to death, personal injury, and / or property damage.

### FASTENERS:

All Westin supplied fasteners must be utilized and installed in accordance with the installation instructions and apply torque to the specifications as defined. **DOUBLE CHECK ALL FASTENERS BEFORE INITIAL USE, AND PERIODICALLY IN THE FUTURE TO ENSURE PROPER FUNCTION AND SAFETY.**

### DRILLING:

Most Westin products do not require drilling for installation. If drilling is defined as required, use caution when drilling a vehicle. **FAILURE TO REVIEW AN AREA TO BE DRILLED MAY RESULT IN PERSONAL INJURY AND/OR INJURY TO OTHERS AS WELL AS VEHICLE DAMAGE.**

### EYE PROTECTION:

**ALWAYS WEAR SAFETY GLASSES OR GOGGLES DURING THE INSTALLATION PROCESS TO AVOID PERSONAL INJURY.**

### MAXIMUM TOWING/CARRYING CAPACITY: (if applicable)

The Westin Receiver Hitches will have a visible tow rating label affixed directly on the product. User should never exceed the vehicle manufacturers maximum tow and weight rating regardless of the capacity of the hitch. **FAILURE TO FOLLOW THESE GUIDELINES WILL VOID THE WESTIN WARRANTY AND MAY RESULT IN PERSONAL INJURY AND/OR INJURY TO OTHERS AS WELL AS VEHICLE DAMAGE.**

### FOR CALIFORNIA RESIDENTS ONLY-PROP 65 WARNING:

Some products may contain chemicals such as DEHP, which can cause cancer, birth defects or other reproductive harm. For more info go to [www.p65warnings.ca.gov](http://www.p65warnings.ca.gov)



Westin Automotive Products, Inc.  
320 W. Covina Blvd  
San Dimas, Ca. 91773